

DS-MP5504 Series Mobile Video Recorder



Main Features

- User-friendly GUI providing easy and flexible operations.
- Pluggable 3G/4G module and Wi-Fi module providing flexible data transmission solutions.
- Built-in GPS (Global Positioning System) module precisely positioning the vehicle via the satellite and recording the location information in the video stream.
- Hikvision private protocol (4000 protocol) and ONVIF supported.
- Accepts access of 4 HD TVI cameras with up to 1080p resolution for each channel.
- Accepts access of 1 IP camera with up to 1080p resolution.
- Pluggable dummy HDD for HDD with up to 2 TB capacity.
- Information collection interfaces collecting driving information such as left/right turn, braking, reversing, etc.
- Specialized aviation connectors ensuring signal stability.
- Shutdown delay (0 h to 6 h) and 24-hour scheduled startup/shutdown.
- Battery protection avoids vehicle from running out of battery.
- Wide-range power input (+9 VDC to +32 VDC).
- Power-off protection prevents key data loss.
- Aluminum die-cast chassis with no fan design well adaptable to working environment.
- Software-based firewall supported.
- Connectable to PTZ camera and PTZ control is supported.
- Support accessing via WEB browser.

Available Models

DS-MP5504

DS-MP5504/GW (Supports 3G dialing)

DS-MP5504/GW/WI58 (Supports 3G dialing and 5.8 G Wi-Fi)

DS-MP5504/GLF (Supports 4G dialing)

DS-MP5504/GLF/WI58 (Supports 4G dialing and 5.8 G Wi-Fi)



Specifications

Model		DS-MP5504
Video/Audio Input	Analog Camera	4 analog cameras with up to 1080p resolution
	IP Camera	1 IP camera with up to 1080p resolution (or extendable via PoE switch)
	Two-way Audio	1-ch (integrated in EXT.DEV interface)
Video/audio output	Video Output	2-ch: 1-ch main output (integrated in EXT.DEV interface). 1-ch VGA video output
	Audio Output	1-ch
Encoding/decoding parameters	Video Compression	H.264, H.264+
	Encoding Resolution	Main stream: 1080p/720p/WD1/4CIF. Sub-Stream: 4CIF/2CIF/CIF
	Frame Rate	<ul style="list-style-type: none"> ● PAL: 1 to 12fps@1080P; NTSC: 1 to 12fps@1080P; ● PAL: 1 to 25fps@720P; NTSC: 1 to 30fps@720P
	Audio Compression	G.711
	Stream Type	Video, Video & Audio
	Audio Bitrate	16 Kbps
	Dual Stream	Supported
Storage	HDD/SSD	1 × 2.5 inch HDD/SSD, up to 2 TB for each HDD/SSD
		A dummy HDD with USB 3.0 interface
	SD Card	1 × SD card, up to 256 GB
Wireless network	3G/4G Dialing	1 × 3G/4G card, 1 × Rosenberger antenna
	Wi-Fi	2 × 5.8 G Wi-Fi SMA antenna
Positioning	GNSS (Global Navigation Satellite System)	GPS (Global Positioning System), 1 × Rosenberger antenna
External interface	Network Interface	1 × 10M/100M RJ45 Ethernet interface
	Serial Port	2 × RS-232, 1 × RS-422 (integrated in EXT.DEV interface)
	USB Interface	<ul style="list-style-type: none"> ● Front panel: 1 × USB 2.0 ● Rear panel: 1 × USB 2.0 of 5-pin aviation connector
	Sensor-in	4 high/low level signal inputs
	Alarm Input	4 high/low level signal inputs, 1 pulse signal input, 1 BUTTON input
	Alarm Output	2 relay signal outputs
General	Operating Method	Mouse, IR remote control, Web control, and touchscreen
	Power Supply	9 to 32 VDC
	Consumption	<ul style="list-style-type: none"> ● Standby: ≤ 0.5 W ● Full load: ≤ 45 W (without peripheral and storage media) Note: Without peripheral and storage media ≤ 20 W
		Working Temperature
	Working Humidity	10% to 90%
	Dimensions (W × D × H)	206 × 219 × 60 mm (8.1 × 8.62 × 2.36 inch)
	Weight (Without Storage Media)	1.6 kg (3.5 lb)

Physical Interfaces

Front Panel

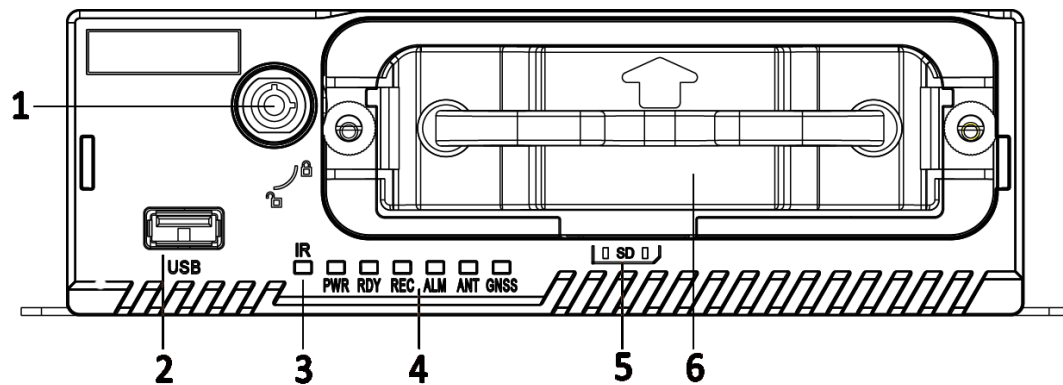



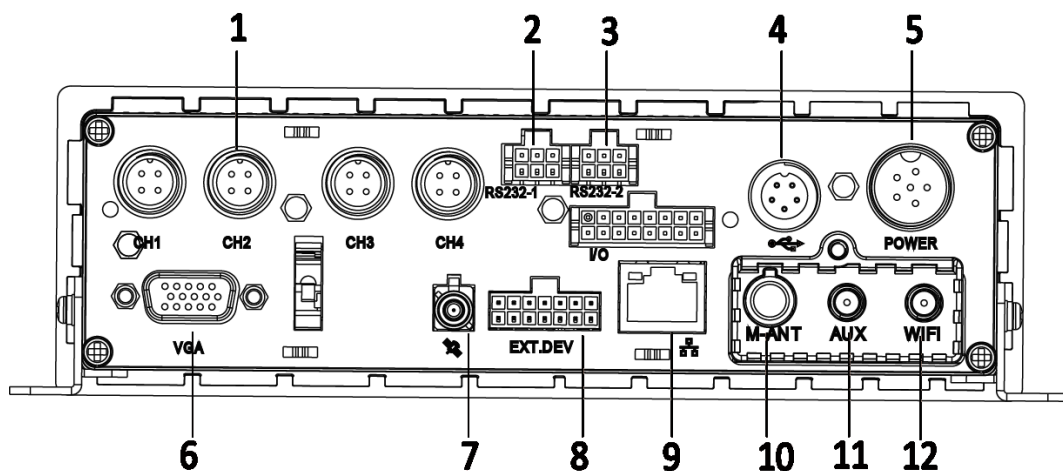

No.	Name	No.	Name
1	Dummy HDD/SSD lock	4	PWR: Power indicator
2	USB 2.0 interface		RDY: Ready indicator
3	IR receiver		REC: Record indicator
5	SD card slot		ALM: Alarm indicator
6	Dummy HDD/SSD		ANT: Dialing indicator
			GNSS: GPS indicator

Rear Panel

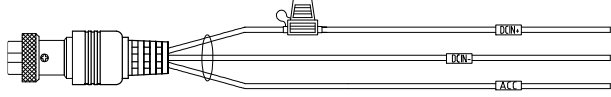
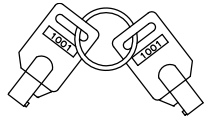
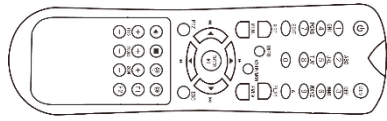
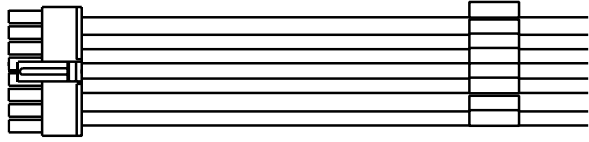

No.	Name	No.	Name
1	Analog video input	7	GNSS antenna interface
2	RS232-1 interface	8	RS-422 communication interface, two-way audio interface, and CVBS video output
3	RS232-2 interface	9	Network interface
4	USB 2.0 or 5-pin aviation connector	10	3G/4G dialing antenna interface
5	Power supply	11	Auxiliary Wi-Fi antenna interface.
6	VGA video output interface	12	Wi-Fi antenna interface.

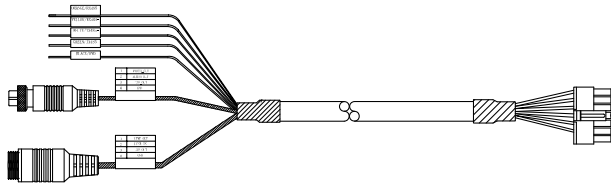
Packing List

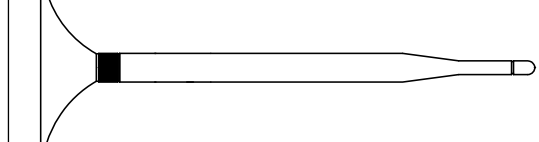
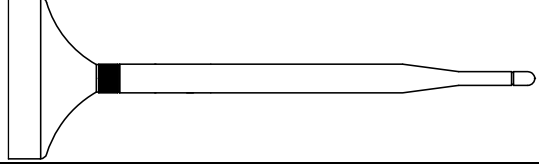
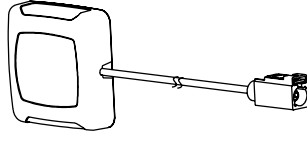
Description	Quantity	Picture	Note
Fuse	2		
Power cord	1		
Key	1		
Remote control	1		
Alarm line	1		
Serial port line	1		
Extension cable	1		
Screwdriver	1		
3G/4G antenna	1		For GW and GLF model.
Wi-Fi antenna (2.4G)	1		For WI model.
Wi-Fi antenna (5.8G)	2		For WI58 model.
GPS antenna	1		For model with GPS module.

Peripheral Connection

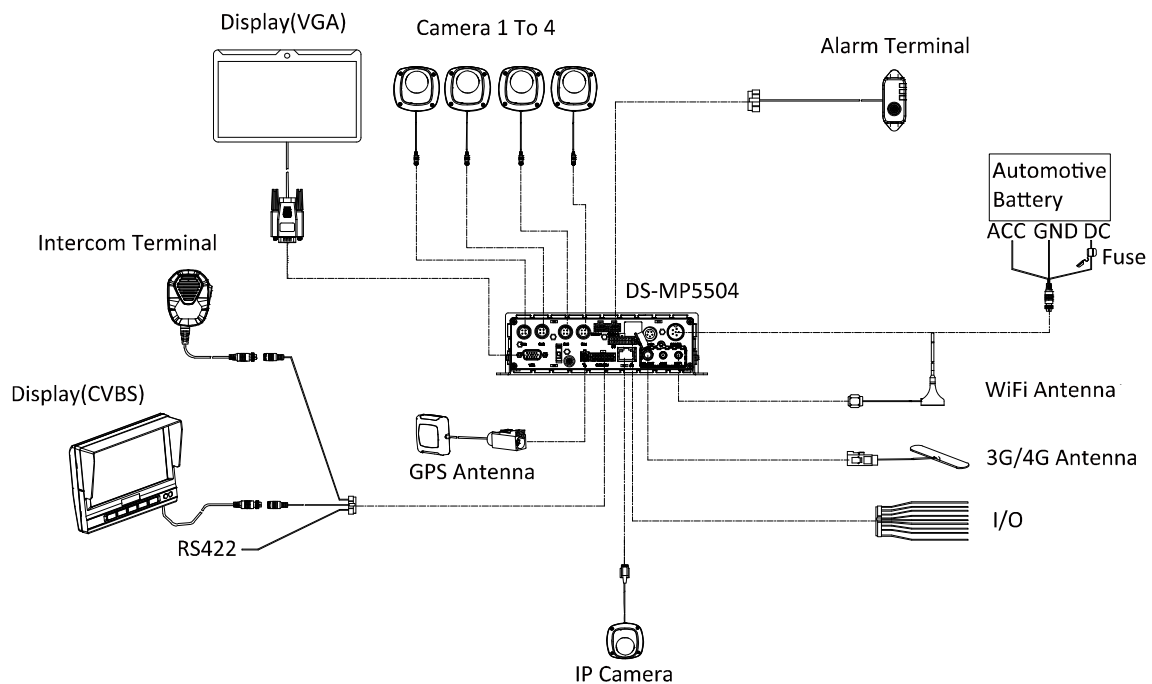

Distributed by



HIKVISION®

Headquarters

No.555 Qianmo Road, Binjiang District,
Hangzhou 310051, China
T +86-571-8807-5998
overseasbusiness@hikvision.com

Hikvision USA
T +1-909-895-0400
sales.usa@hikvision.com

Hikvision Australia
T +61-2-8599-4233
salesau@hikvision.com

Hikvision India
T +91-22-28469900
sales@pramahikvision.com

Hikvision Canada
T +1-866-200-6690
sales.canada@hikvision.com

Hikvision Thailand
T +662-275-9949
sales.thailand@hikvision.com

Hikvision Europe
T +31-23-5542770
sales.eu@hikvision.com

Hikvision Italy
T +39-0438-6902
info.it@hikvision.com

Hikvision Brazil
T +55 11 3318-0050
Latam.support@hikvision.com

Hikvision Turkey
T +90 [216]521 7070- 7074
sales.tr@hikvision.com

Hikvision Malaysia
T +601-7652-2413
sales.my@hikvision.com

Hikvision UK & Ireland
T +01628-902140
sales.uk@hikvision.com

Hikvision South Africa
Tel: +27 (10) 0351172
sale.africa@hikvision.com

Hikvision France
T +33(0)1-85-330-450
info.fr@hikvision.com

Hikvision Kazakhstan
T +7-727-9730667
nikia.panfilov@hikvision.ru

Hikvision Vietnam
T +84-974270888
sales.vt@hikvision.com

Hikvision UAE
T +971-4-4432090
salesme@hikvision.com

Hikvision Singapore
T +65-6684-4718
sg@hikvision.com

Hikvision Spain
T +34-91-737-16-55
info.es@hikvision.com

Hikvision Tashkent
T +99-87-1238-9438
uzb@hikvision.ru

Hikvision Hong Kong
T +852-2151-1761
info.hk@hikvision.com

Hikvision Russia
T +7-495-669-67-99
saleru@hikvision.com

Hikvision Korea
T +82-(0)31-731-8817
sales.korea@hikvision.com

Hikvision Poland
T +48-22-460-01-50
info.pl@hikvision.com

Hikvision Indonesia
T +62-21-2933759
Sales.Indonesia@hikvision.com

Hikvision Colombia
sales.colombia@hikvision.com