

DS-MP5604 Series Mobile Video Recorder

Key Feature

- User-friendly GUI providing easy and flexible operations.
- Pluggable 3G/4G module and Wi-Fi module providing flexible data transmission solutions.
- Built-in GPS module precisely positioning the vehicle via the satellite and recording the location information in the video stream.
- Hikvision private protocol (4000 protocol) and ONVIF supported.
- Access of 4 HD TVI cameras with up to 1080p resolution.
- Access of 4 IP cameras with up to 1080p resolution.
- Pluggable dummy HDD for HDD with up to 2 TB capacity.
- Information collection interfaces collecting driving information such as left/right turn, braking, reversing, etc.
- Specialized aviation connectors ensuring signal stability.
- Shutdown delay (0 h to 6 h) and 24-hour scheduled startup/shutdown.
- Battery protection avoids vehicle from running out of battery.
- Wide-range power input (+9 VDC to +32 VDC).
- Power-off protection prevents key data loss.
- Aluminum die-cast chassis with no fan design well adaptable to working environment.
- Software-based firewall supported.
- Connectable to PTZ camera and PTZ control is supported.
- Support accessing via WEB browser.



Available Model

DS-MP5604

DS-MP5604/GW, (supports 3G dialing)

DS-MP5604/GW/WI58, (supports 3G dialing and 5.8G Wi-Fi)

DS-MP5604/GLF, (supports 4G dialing)

DS-MP5604/GLF/WI58, (supports 4G dialing and 5.8G Wi-Fi)



Specification

| Model | | DS-MP5604 |
|------------------------------|---|---|
| Video/Audio Input | Analog Camera | 4 analog cameras, up to 1080p resolution |
| | IP Camera | 4 IP cameras, up to 1080p resolution (extendable via PoE switch) |
| | Two-way Audio | 1, integrated in EXT.DEV interface |
| Video/Audio Output | Video Output | Main output: 1, integrated in EXT.DEV interface VGA: 1 |
| | Audio Output | 1 |
| Encoding/Decoding Parameters | Video Compression | H.264/H.265 |
| | Encoding Resolution | Main stream: 1080p/720p/WD1/4CIF Sub-stream: 720P/WD1/4CIF/2CIF/CIF |
| | Frame Rate | <ul style="list-style-type: none"> ● PAL: 1 to 15 fps@1080P; NTSC: 1 to 15 fps@1080P; ● PAL: 1 to 25 fps@720P; NTSC: 1 to 30 fps@720P |
| | Audio Compression | G.711/G.722.1 |
| | Stream Type | Video, video & audio |
| | Audio Bitrate | 16 Kbps |
| | Dual Stream | Supported |
| Storage | HDD/SSD | 1 × 2.5 inch HDD/SSD, up to 2 TB for each HDD/SSD A dummy HDD with USB 3.0 interface |
| | SD Card | 1 × SD card, up to 256 GB |
| Wireless Network | 3G/4G Dialing | 1 × 3G/4G card slot, 1 × Rosenberger antenna |
| | Wi-Fi | WI58 model: 2 × 5.8 G Wi-Fi SMA antenna |
| Positioning | GNSS (Global Navigation Satellite System) | GPS (Global Positioning System) & GLONASS (Global Navigation Satellite System), 1 × Rosenberger antenna |
| External Interface | Network Interface | 1 × 10M/100M M12 6-pin aviation connector |
| | Serial Port | 2 × RS-232, 1 × RS-422 (integrated in EXT.DEV interface) |
| | USB Interface | <ul style="list-style-type: none"> ● Front panel: 1 × USB 2.0 ● Rear panel: 1 × USB 2.0 (5-pin aviation connector) |
| | Sensor-in | 4 high/low level signal inputs |
| | Alarm Input | 4 high/low level signal inputs, 1 pulse signal input, 1 BUTTON input |
| | Alarm Output | 2 relay signal outputs |
| General | Operating Method | Mouse, IR remote control, Web control, and touchscreen |
| | Power Supply | 9 to 32 VDC |
| | Consumption | <ul style="list-style-type: none"> ● Standby: ≤ 0.5 W ● Full load: ≤ 45 W Note: Without peripheral and storage media ≤ 20 W |
| | Working Temperature | <ul style="list-style-type: none"> ● Device that provides dummy HDD with heating function: -30 °C to +60 °C (-22 °F to +140°F) ● Other devices: -10 °C to +60 °C (+14 °F to +140°F) |
| | Working Humidity | 10% to 95% |
| | Dimension (W × D × H) | 206 × 225.4 × 60.1 mm (8.1 × 8.87 × 2.37 inch) |
| | Weight (Without Storage Media) | 1.7 kg (3.7 lb) |

Physical Interface

Front Panel

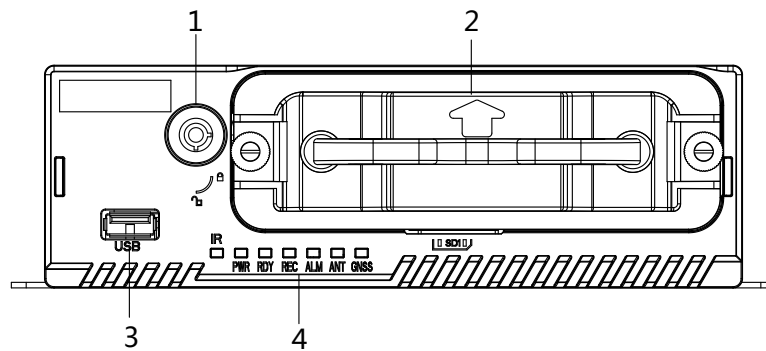



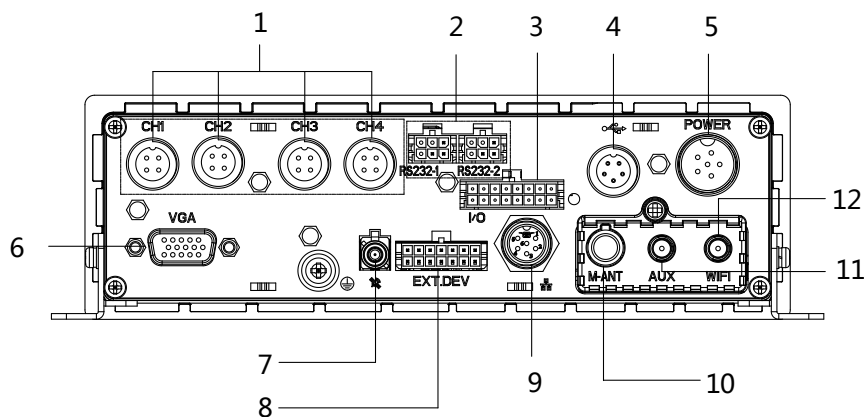

| No. | Name | No. | Name |
|-----|--------------------|-----|------------------------|
| 1 | Dummy HDD/SSD lock | 4 | PWR: Power indicator |
| 2 | Dummy HDD/SSD | | RDY: Ready indicator |
| 3 | USB 2.0 interface | | REC: Record indicator |
| | | | ALM: Alarm indicator |
| | | | ANT: Dialing indicator |
| | | | GNSS: GPS indicator |

Rear Panel

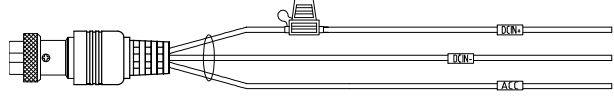
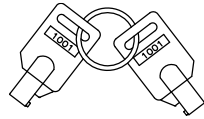
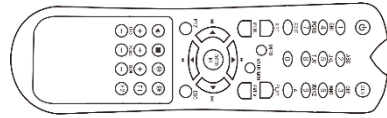

| No. | Name | No. | Name |
|-----|-------------------------------------|-----|--|
| 1 | Analog camera input | 7 | GNSS antenna interface |
| 2 | RS-232 interface | 8 | RS-422 communication interface, two-way audio interface, and CVBS video output |
| 3 | Alarm in, alarm out, and sensor-in | 9 | Network interface |
| 4 | USB 2.0 of 5-pin aviation connector | 10 | 3G/4G dialing antenna interface |
| 5 | Power supply | 11 | Auxiliary Wi-Fi antenna interface |
| 6 | VGA video output interface | 12 | Wi-Fi antenna interface |

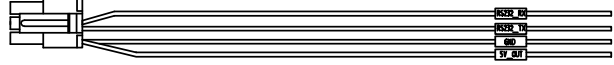
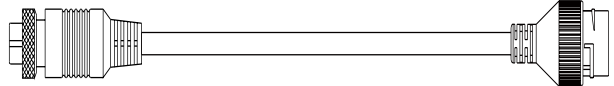
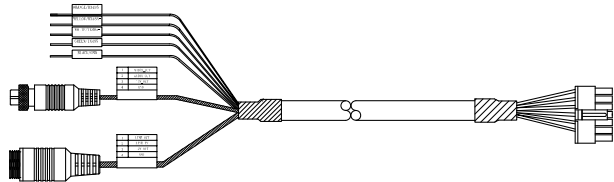
Packing List

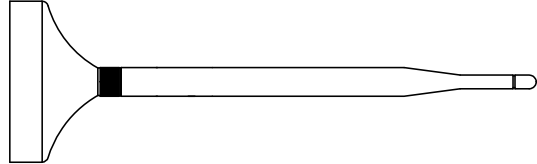
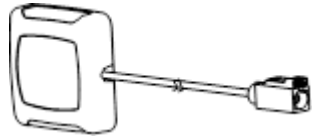
| Description | Quantity | Picture | Note |
|---|----------|--|----------------------------|
| Fuse | 2 |  | |
| Power cord | 1 |  | |
| Key | 1 |  | |
| Remote control | 1 |  | |
| Alarm line | 1 |  | |
| RS-232 line | 1 |  | |
| Switching line of 6-pin connector to RJ45 interface | 1 |  | |
| Extension cable | 1 |  | |
| Screwdriver | 1 |  | |
| 3G/4G antenna | 1 |  | For GW/GLF model. |
| Wi-Fi antenna (5.8G) | 2 |  | For W158 model. |
| GPS antenna | 1 |  | For model with GPS module. |

Peripheral Connection

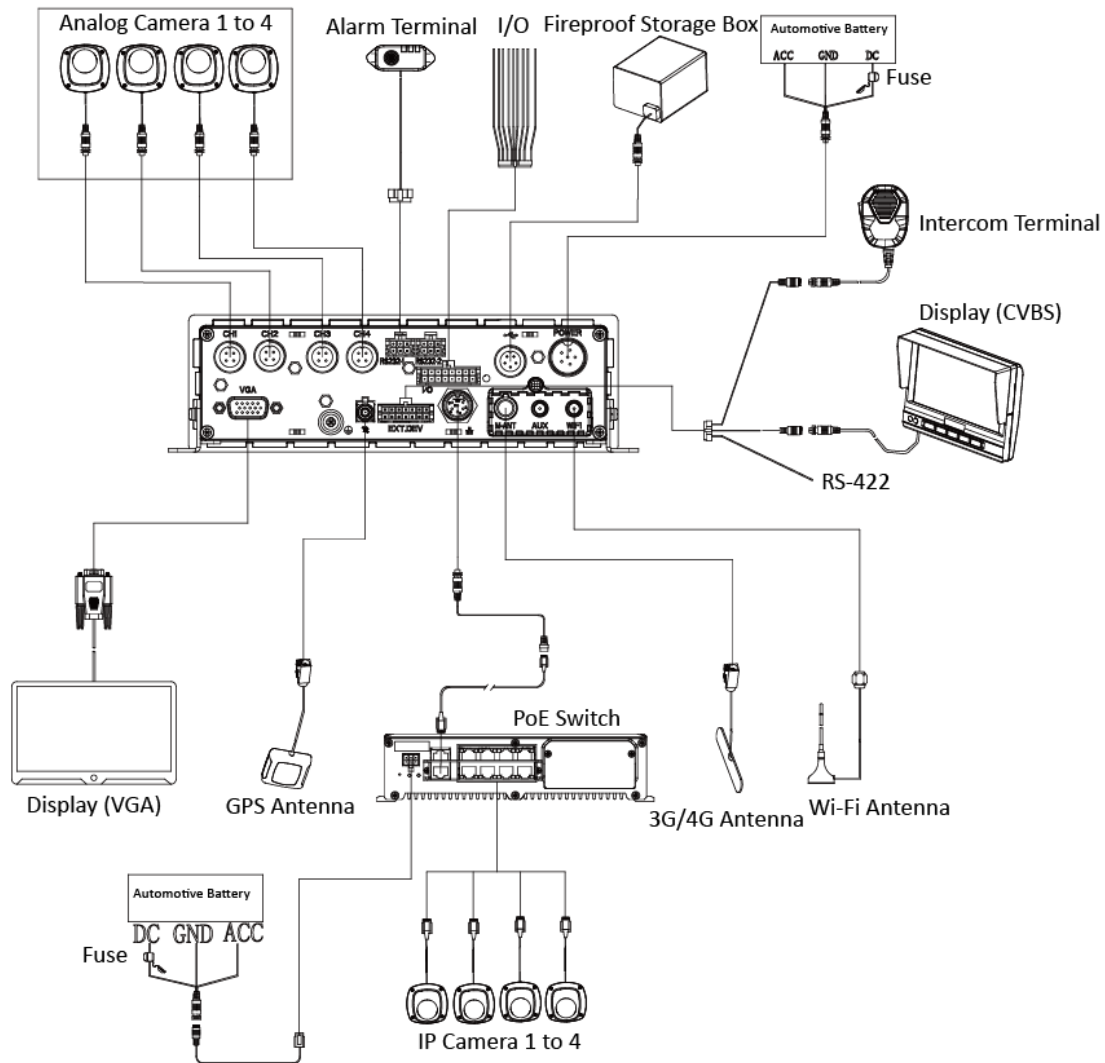

Distributed by

HIKVISION®

Headquarters

No.555 Qianmo Road, Binjiang District,
Hangzhou 310051, China
T +86-571-8807-5998
overseasbusiness@hikvision.com

Hikvision USA
T +1-909-895-0400
sales.usa@hikvision.com

Hikvision Australia
T +61-2-8599-4233
salesau@hikvision.com

Hikvision India
T +91-22-28469900
sales@pramahikvision.com

Hikvision Canada
T +1-866-200-6690
sales.canada@hikvision.com

Hikvision Thailand
T +662-275-9949
sales.thailand@hikvision.com

Hikvision Europe
T +31-23-5542770
sales.eu@hikvision.com

Hikvision Italy
T +39-0438-6902
info.it@hikvision.com

Hikvision Brazil
T +55 11 3318-0050
Latam.support@hikvision.com

Hikvision Turkey
T +90 [216]521 7070- 7074
sales.tr@hikvision.com

Hikvision Malaysia
T +601-7652-2413
sales.my@hikvision.com

Hikvision UK & Ireland
T +01628-902140
sales.uk@hikvision.com

Hikvision South Africa
Tel: +27 (10) 0351172
sale.africa@hikvision.com

Hikvision France
T +33(0)1-85-330-450
info.fr@hikvision.com

Hikvision Kazakhstan
T +7-727-9730667
nikia.panfilov@hikvision.ru

Hikvision Vietnam
T +84-974270888
sales.vt@hikvision.com

Hikvision UAE
T +971-4-4432090
salesme@hikvision.com

Hikvision Singapore
T +65-6684-4718
sg@hikvision.com

Hikvision Spain
T +34-91-737-16-55
info.es@hikvision.com

Hikvision Tashkent
T +99-87-1238-9438
uzb@hikvision.ru

Hikvision Hong Kong
T +852-2151-1761
info.hk@hikvision.com

Hikvision Russia
T +7-495-669-67-99
saleru@hikvision.com

Hikvision Korea
T +82-(0)31-731-8817
sales.korea@hikvision.com

Hikvision Poland
T +48-22-460-01-50
info.pl@hikvision.com

Hikvision Indonesia
T +62-21-2933759
Sales.Indonesia@hikvision.com

Hikvision Colombia
sales.colombia@hikvision.com