



No 2014-3708

TEST REPORT

Equipment under Test: Mobile Digital Video Recorder

Model Number: DS-90XXHMF1-ST

Manufacturer: Hangzhou Hikvision Digital Technology Co., Ltd.

Test Standards: EN 50155:2007

Results: PASS

Date of issues: 2014-9-28

NATIONAL COMPUTER PERIPHERAL EQUIPMENT

QUALITY SUPERVISING TEST CENTRE

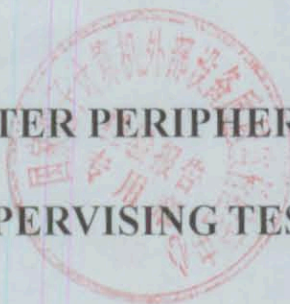

VERIFICATION OF COMPLIANCE

Equipment under Test:	Mobile Digital Video Recorder
Trade Name:	N/A
Model Number:	DS-90XXHMF1-ST
Serial Number:	473202670
Applicant:	Hangzhou Hikvision Digital Technology Co., Ltd.
Manufacturer:	Hangzhou Hikvision Digital Technology Co., Ltd.
Type of Test:	Entrustment Test
Technical Standards:	EN 50155: 2007; EN 50121-3-2:2006;
Verification Issuing Office Name & Address	National Computer Peripheral Equipment Quality Supervising Test Centre (CPTC) 36# Macheng Road, HangZhou City, Zhejiang Province, China
File Number:	2014-3708
Delivery Date:	2014-09-22
Condition of Test Sample:	Normal

This report shall not be reproduced, except in full, without the written approval of CPTC

The test results of this report relate only to the tested sample identified in this report.

Approved by:

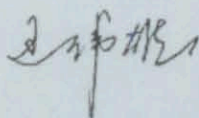

Checked by:

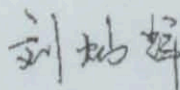

Chief tester:

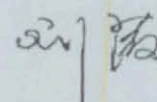

Contents

1. GENERAL INFORMATION.....	1
1.1 TEST ITEMS.....	1
1.2 EUT (EQUIPMENT UNDER TEST) INFORMATION	4
1.3 TEST DESCRIPTION	4
1.4 AMBIENT CONDITION FOR TEST	4
1.5 REQUIREMENTS	4
1.6 TEST EQUIPMENT LIST.....	5
2. CONDUCTED EMISSION TEST	7
2.1 TEST STANDARDS	7
2.2 DIAGRAM OF TEST SETUP.....	7
2.3 TEST DESCRIPTION	7
2.4 TEST RESULT	11
3. RADIATED EMISSION TEST	12
3.1 TEST STANDARDS	12
3.2 DIAGRAM OF TEST SETUP.....	12
3.3 TEST EQUIPMENTS USED	12
3.4 TEST DESCRIPTION	12
3.5 TEST RESULT	14
4. ELECTROSTATIC DISCHARGE TEST	15
4.1 TEST STANDARDS	15
4.2 SEVERITY LEVELS AND PERFORMANCE CRITERION	15
4.3 DIAGRAM OF TEST SETUP.....	15
4.4 TEST EQUIPMENTS USED	15
4.5 TEST DESCRIPTION	15
4.6 TEST SETTING.....	16
4.7 TEST RESULT	16
5. RF FIELD STRENGTH SUSCEPTIBILITY TEST	17
5.1 TEST STANDARDS	17
5.2 SEVERITY LEVELS AND PERFORMANCE CRITERION	17
5.3 DIAGRAM OF TEST SETUP.....	17
5.4 TEST EQUIPMENT USED	17
5.5 TEST DESCRIPTION	17

5.6 TEST SETTING	18
5.7 TEST RESULT	18
6. ELECTRICAL FAST TRANSIENT/BURST TEST	19
6.1 TEST STANDARDS	19
6.2 SEVERITY LEVELS AND PERFORMANCE CRITERION	19
6.3 DIAGRAM OF TEST SETUP	19
6.4 TEST EQUIPMENT USED	20
6.5 TEST DESCRIPTION	20
6.6 TEST SETTING	20
6.7 TEST RESULT	20
7. SURGE TEST	21
7.1 TEST STANDARDS	21
7.2 SEVERITY LEVELS AND PERFORMANCE CRITERION	21
7.3 DIAGRAM OF TEST SETUP	21
7.4 TEST EQUIPMENT USED	21
7.5 TEST DESCRIPTION	21
7.6 TEST SETTING	22
7.7 TEST RESULT	22
8. CONDUCTED SUSCEPTIBILITY TEST	23
8.1 TEST STANDARDS	23
8.2 SEVERITY LEVELS AND PERFORMANCE CRITERION	23
8.3 DIAGRAM OF TEST SETUP	23
8.4 TEST EQUIPMENT USED	23
8.5 TEST DESCRIPTION	23
8.6 TEST SETTING	24
8.7 TEST RESULT	24
9. POWER SUPPLY OVER VOLTAGE	25
9.1 TEST STANDARDS	25
9.2 DIAGRAM OF TEST SETUP	25
9.3 TEST CONFIGURATION AND PROCEDURE	25
9.4 TEST SETTING	25
9.5 TEST RESULT	25
10. VIBRATION TEST	26
10.1 TEST PROCEDURE	27
10.2 ACCEPTANCE CRITERIA	27

10.3 TEST SETTING.....	27
10.4 TEST RESULT.....	27
11. SHOCK TEST.....	28
11.1 TEST PROCEDURE:.....	28
11.2 ACCEPTANCE CRITERIA.....	28
11.3 TEST SETTING:.....	28
11.4 TEST RESULT.....	28
12. DRY HEAT TEST.....	29
12.1 TEST PROCEDURES.....	29
12.2 ACCEPTANCE CRITERIA.....	29
12.3 TEST SETTING.....	29
12.3 TEST RESULT.....	29
13. COOLING TEST.....	29
13.1 TEST PROCEDURES.....	30
13.2 ACCEPTANCE CRITERIA.....	30
13.3 TEST SETTING.....	30
13.4 TEST RESULT.....	30

1. General Information

All tests that mentioned in this document are according to the test procedure of EN 50155.

1.1 Test Items

No.	Phenomenon	Basic standard	Severity	Performance Criteria ^①	Result
1.	Conducted Emission	EN 50155 12.2.8.2 EN 50121-3-2 table 5 Ref EN 55011 clause 7	9 kHz – 150 kHz: No limit 150 kHz – 500 kHz: 79 dB V quasi-peak 500 kHz – 30 MHz: 73 dB V quasi-peak	N/A	Pass
2.	Radiated Emission	EN 50155 12.2.8.2 EN 50121-3-2 table 6 Ref EN 55011 clause 7	30 MHz – 230 MHz: 50 dB V/m quasi-peak @3m 230 MHz – 1 GHz: 57 dB V/m quasi-peak @3m	N/A	Pass
3.	ESD	EN 50155 12.2.7.2 EN50121-3-2 table 9 Ref : IEC 61000-4-2	8 KV air discharge 6 KV Contact discharge	A	Pass
4.	Radio frequency	EN 50155 12.2.8.1 EN 50121-3-2 table 9 Ref : IEC 61000-4-3	Electric Field Strengthen (V/m) in rms : 80 MHz to 1GHz 20V/m 1.4GHz to 2.1GHz 10V/m 2.1GHz to 2.7GHz 5V/m Modulation : 80% AM (1kHz) for all ranges	A	Pass

No.	Phenomenon	Basic standard	Severity	Performance Criteria ^①	Result
5.	Fast Transients bursts	EN50155 12.2.7.3 EN50121-3-2 table 7&8 Ref: IEC 61000-4-4 clause 8	+/-2 kV 5/50 ns Tr/Th 5 kHz repetition frequency	A	Pass
6.	Surges	EN 50155 12.2.7.1 EN50121-3-2 table 7 Ref: IEC 61000-4-5 Clause 8	1.2/50 μ s Open circuit test voltage line to ground: +/- 2KV 42 Ω , 0.5 μ F Open circuit test voltage line to line: +/- 1KV 42 Ω , 0.5 μ F	B	Pass
7.	Conducted radio frequency	EN 50155 12.2.8.1 EN 50121-3-2 table 7&8 Ref: IEC 61000-4-6 Clause 8	10 Vrms (carrier voltage) 150 kHz to 80 MHz 1 kHz, 80% AM	A	Pass
8.	Supply Over Voltage	EN 50155 12.2.6	1.4 Un, d=0.1sec, D=1sec, Rs = 1 Ω +/- 10% Trapezoidal overvoltage according to EN50155 12.2.6 a)	A	Pass
9.	Performance Test	EN 50155 12.2.2	0.7Un-1.25Un	N/A	Pass
10.	Vibration Test	EN 50155 12.2.11 EN 61373 table 1 & 2	Category 2 (Bogie mounted) according to EN 61373 table 1 & 2	N/A	Pass
11.	Shock Test	EN 50155 12.2.11 EN 61373 table 3	Category 2 (Bogie mounted) according to EN 61373 table 3	N/A	Pass

No.	Phenomenon	Basic standard	Severity	Performance Criteria ^①	Result
12.	Dry heat	EN50155 12.2.4 EN60068-2-2 test Bd	70°C, 8h(power on)	N/A	Pass
13.	Cooling test	EN50155 12.2.3 EN60068-2-1 test Ad	-25°C, stay for 2h,then Power on for 8h	N/A	Pass

①Note: Performance Criteria

Criterion A:

The apparatus shall continue to operate as intended without operator intervention. No degradation of performance or loss of function is allowed below a performance level specified by the manufacturer when the equipment is used as intended. The performance level may be replaced by a permissible loss of performance. If the minimum performance level or the permissible performance loss is not specified by the manufacturer, then either of these may be derived from the product description and documentation, and by what the user may reasonably expect from the equipment if used as intended.

Criterion B:

After the test, the equipment shall continue to operate as intended without operator intervention. No degradation of performance or loss of function is allowed below a performance level (or permissible loss of performance) specified by the manufacturer, when the apparatus is used as intended. During the test, degradation of performance is allowed, however. No change of actual operating state or stored data is allowed. If the minimum performance level or the permissible performance loss is not specified by the manufacturer, then either of these may be derived from the product description and documentation, and from what the user may reasonably expect from the apparatus if used as intended.

Criterion C:

Temporary loss of function is allowed, provided the function is self-recoverable or can be restored by the operation of the controls, or by any operation specified in the instructions for use.

1.2 EUT (Equipment Under Test) Information

Name: Mobile Digital Video Recorder

Test Model No.: DS-90XXHMF1-ST

Power Supply: DC 8-36V

1.3 Test Description

1.3.1 Accessories Used

Name	Model	Manufacturer
Camera	DS-2CS58A1P(N)-IRS	Hikvision
LCD monitor	SMT-1722P	Samsung

1.4 Ambient Condition for Test

Item	Required
Temperature (°C)	15~35
Humidity (%RH)	25~75
Barometric Pressure (mbar)	860~1060

1.5 Requirements

1.5.1 EMC test requirements

Emission: The equipment under test (EUT) was configured to measure its highest possible radiation level. The test modes were adapted accordingly in reference to the Operating Instructions.

The performance acceptance criteria are defined as: The overall emission level do not exceed the limits.

Immunity: The equipment under test (EUT) was configured to the representative operating mode and conditions.

The performance acceptance criteria are defined as: Meet the Performance Criteria of 1.1.

1.5.2 Environment test requirements

The acceptance criteria are defined as:

- a) No failure or damage shall occur
- b) The functional check shall not show any failure or damage nor any results which are beyond the specified tolerance

1.5.3 Requirements for functional check.

The performance acceptance criteria are defined as:

Correct video and audio signal being received and transmitted.

Slight disturbance, flickering or jittering observed on the preview screen is permitted.

1.6 Test Equipment List

For ESD test:

Manufacturer/Type	Model No.	Serial No.	Last Cal.	Cal. Due
Schaffner ESD Generator	NSG438	DC0074	02/06/2014	01/06/2015

For Radiated Electromagnetic Field immunity Measurement:

Manufacturer/Type	Model No.	Serial No.	Last Cal.	Cal. Due
FLUKE /Signal Generator	N5181A	DC0106-3	11/06/2014	10/06/2015
AR/Power Amplifier	AS0102	DC0106-7	N/A	N/A
AR/Power Amplifier	CBA1G	DC0106-9	N/A	N/A
AR/Field probes	HI-6105	DC0106-9	18/04/2014	17/04/2015

For Radiated Emission Measurement:

Manufacturer/Type	Model No.	Serial No.	Last Cal.	Cal. Due
R&S EMI Receiver	ESIB26	DC0065	17/06/2014	16/06/2015
All band antenna	CBL6112A	DC0068	N/A	N/A
Anechoic chamber	966	SB053	N/A	N/A

For Conducted Emission Measurement:

Manufacturer/Type	Model No.	Serial No.	Last Cal.	Cal. Due
R&S EMI Receiver	ESIB26	DC0065	17/06/2014	16/06/2015
Line Impedance Stabilization Network	ESH3-Z5	DC0067	N/A	N/A

For Fast Transients/Burst test:

Manufacturer/Type	Model No.	Serial No.	Last Cal.	Cal. Due
Schaffner Fast Transients /Burst Generator	NSG2025	DC0071	28/06/2014	27/06/2015

For immunity to Conducted Disturbance /Induced by Radio-Frequency Field :

Manufacturer/Type	Model No.	Serial No.	Last Cal.	Cal. Due
SCHAFFNER/RF Generator	NSG2070	DC0070	13/09/2014	12/09/2015
SCHAFFNER /CDN M3	CDN-M316	15864	25/09/2013	24/09/2014

SCHAFFNER /CDN M2	CDN-M216	12761	25/09/2014	24/09/2015
-------------------	----------	-------	------------	------------

For Surge/ Voltage Dips/ Short Interruption and Voltage Variation Immunity test:

Manufacturer/Type	Model No.	Serial No.	Last Cal.	Cal. Due
SCHAFFNER/Surge /Dips/Interruption and Variations Simulator	NSG2050	DC0011	13/03/2013	12/03/2015

For Cooling/Dry Heat test

Manufacturer/Type	Model No.	Serial No.	Last Cal.	Cal. Due
Temperature & Humidity Chamber	ESL-10AGP	SB055	13/03/2014	12/03/2015
Temperature & Humidity Chamber	C/WJS-100L	SB115	13/12/2014	14/12/2015

For Vibration, Shock, and Bump test

Manufacturer/Type	Model No.	Serial No.	Last Cal.	Cal. Due
Vibration	DCS-1000-10-05	SB077	11/06/2014	10/06/2015
Shock and Bump	SB-200	SB112	19/05/2014	18/05/2015

2. Conducted Emission Test

2.1 Test Standards

EN 55011 clause 7

2.2 Diagram of Test Setup

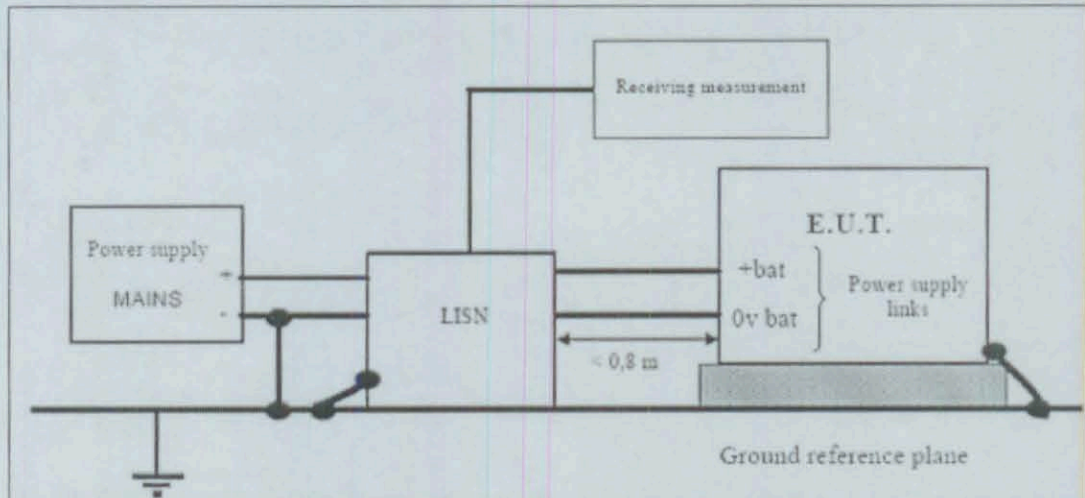

2.3 Test Description

2.3.1 Configuration of Instruments

Test Equipments Used

EQP. Description
LISN: Line Impedance Stabilization Network
R&S EMI Receiver

Test Receiver Setting



Detector: Quasi-Peak and Average

Band Width: 9KHz

Frequency Range: 150KHz to 30MHz

Reported Emission:

Power-L

EUT:

Manufacturer:

Operating Condition:

Test Site:

Operator: Huang daming

Test Specification:

Comment:

SCAN TABLE: "EN 55022 V fin"

Start Frequency	Stop Frequency	Step Width	Detector	Meas. Time	IF Bandw.	Transducer
150.0 kHz	30.0 MHz	4.0 kHz	QuasiPeak	1.0 s	9 kHz	NNLK-8121(52)
Average						

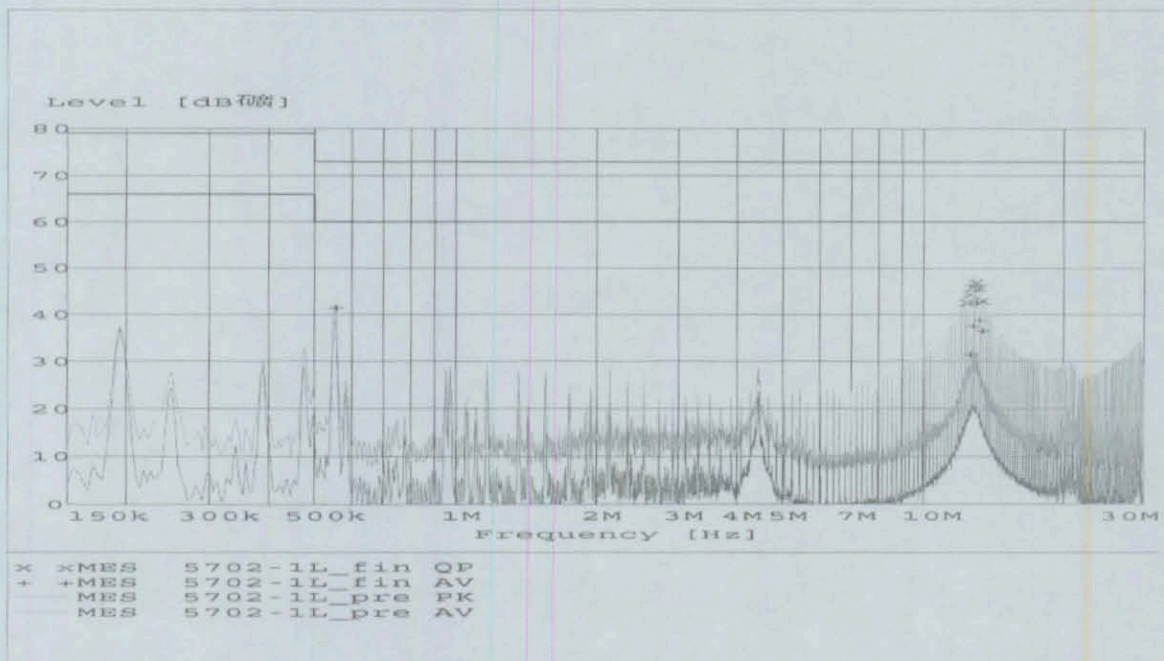

MEASUREMENT RESULT: "5702-1L_fin QP"

9/24/14 6:07PM

Frequency	Level	Transd	Limit	Margin	Line	PE
MHz	dBµV		dB	dBµV	dB	
12.242000	42.70	11.1	73	30.3	L1	GND
12.442000	44.50	11.1	73	28.5	L1	GND
12.630000	46.10	11.1	73	26.9	L1	GND
12.826000	47.10	11.1	73	25.9	L1	GND

13.026000	46.00	11.1	73	27.0	L1	GND
13.222000	43.10	11.1	73	29.9	L1	GND

MEASUREMENT RESULT: "5702-1L_fin AV"

9/24/14 6:07PM

Frequency MHz	Level dBμV	Transd	Limit dB	Margin dBμV	Line dB	PE
0.550000	41.70	10.1	60	18.3	L1	GND
12.442000	31.70	11.1	60	28.3	L1	GND
12.634000	37.80	11.1	60	22.2	L1	GND
12.826000	42.80	11.1	60	17.2	L1	GND
13.026000	39.00	11.1	60	21.0	L1	GND
13.218000	36.70	11.1	60	23.3	L1	GND

Power-N

EUT:

Manufacturer:

Operating Condition:

Test Site:

Operator: Huang damping

Test Specification:

Comment:

SCAN TABLE: "EN 55022 V fin"

Start Frequency	Stop Frequency	Step Width	Detector	Meas. Time	IF Bandw.	Transducer
150.0 kHz	30.0 MHz	4.0 kHz	QuasiPeak	1.0 s	9 kHz	NNLK-8121(52)
Average						

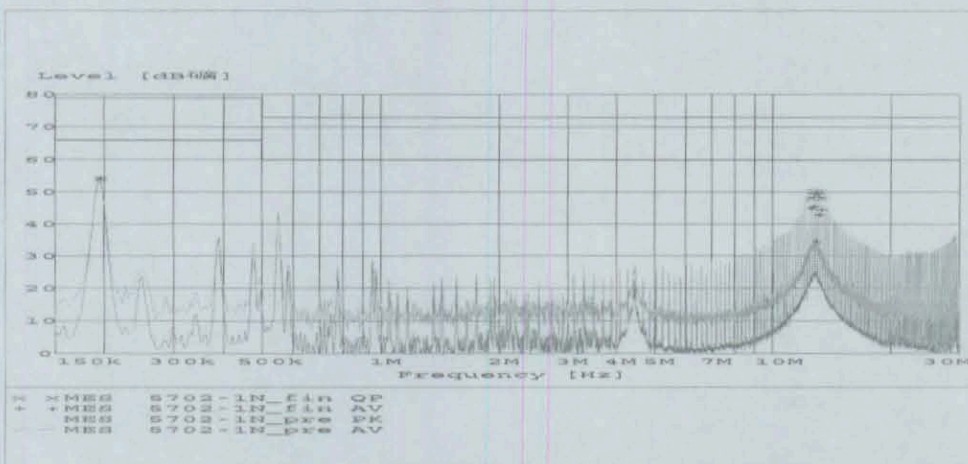

MEASUREMENT RESULT: "5702-1N_fin QP"

9/24/14 6:11PM

Frequency MHz	Level dB μ V	Transd	Limit dB	Margin dB μ V	Line dB	PE
0.194000	54.30	10.1	79	24.7	N	GND
12.434000	48.20	11.1	73	24.8	N	GND
12.634000	50.40	11.1	73	22.6	N	GND
12.822000	49.20	11.1	73	23.8	N	GND
13.018000	50.30	11.1	73	22.7	N	GND
13.218000	48.30	11.1	73	24.7	N	GND

MEASUREMENT RESULT: "5702-1N_fin AV"

9/24/14 6:11PM

Frequency MHz	Level dB μ V	Transd	Limit dB	Margin dB μ V	Line dB	PE
0.194000	54.50	10.1	66	11.5	N	GND
12.438000	45.10	11.1	60	14.9	N	GND
12.634000	45.70	11.1	60	14.3	N	GND
12.818000	34.80	11.1	60	25.2	N	GND
13.018000	43.10	11.1	60	16.9	N	GND
13.218000	44.70	11.1	60	15.3	N	GND

The objective of this test is to check the compliance of the equipment to the EN55011 standard. It deals with measuring the conducted disturbance level emitted by power supply conductors, video ports conductors in the frequency band 150 kHz - 30 MHz. Test procedures are defined in the standards EN 55011.

2.3.2 Conducted Emission Limit

Frequency Range (MHz)	Limits (dBuV)
	Quasi-Peak
0.090~0.150	N.A
0.150~0.500	79
0.500~30.000	73

2.3.3 Operating Condition of EUT

EUT is turned on during the test, and the maximum emanating results are recorded.

2.3.4 Test Configuration and Procedure

EUT is placed on a nonmetal table which is 0.8 meter above the grounded reference plane. Connect the lines under testing of the EUT to the LISN which is connected to receiver by coaxial line, then disturbance signals from the lines can be detected by the receiver.

2.4 Test Result

Pass: The overall emission level do not exceed the limits as stated in section 2.3.2

3. Radiated Emission Test

3.1 Test Standards

EN 55011 clause 7

3.2 Diagram of Test Setup

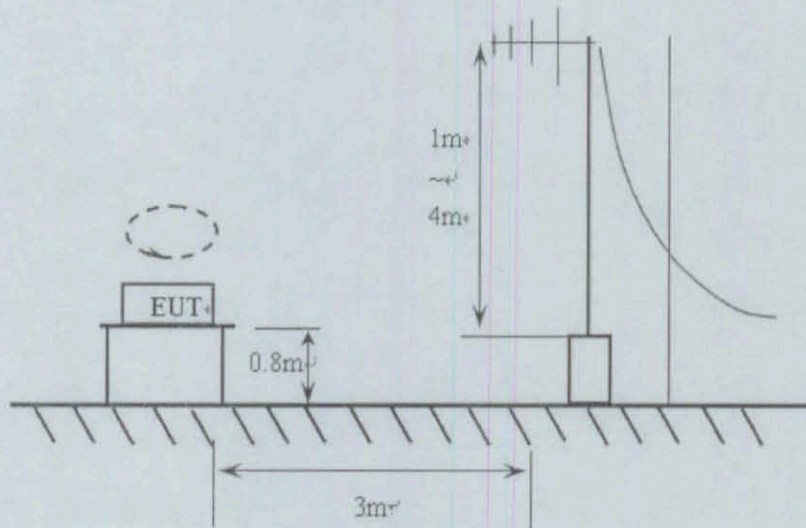

3.3 Test Equipments Used

EQP. Description
All band antenna
R&S EMI Receiver

3.4 Test Description

3.4.1 Configuration of Instruments

Test Receiver Setting

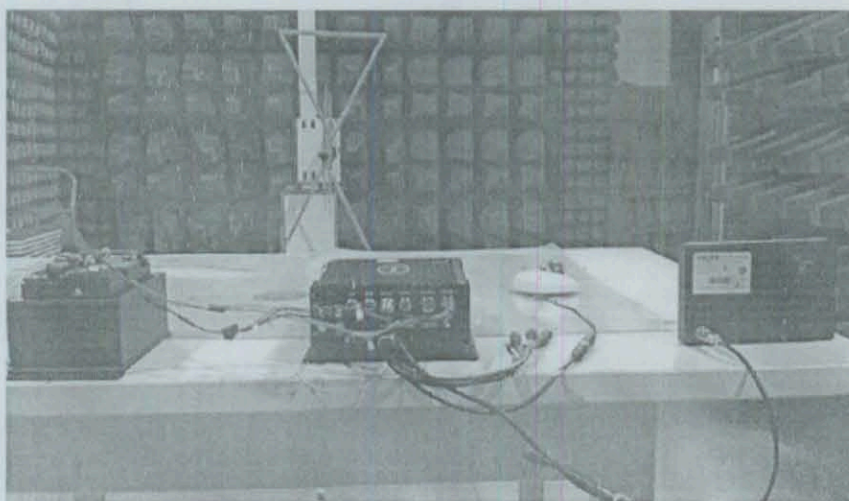

- Detector: Quasi-Peak
- Band Width: 120KHz
- Frequency Range: 30MHz to 1000MHz

-Turntable Rotated: 0 to 360 degrees

Antenna Position:

-Height: 1m to 4m

-Polarity: Horizontal and Vertical

Reported Emission:

EUT:

Manufacturer:

Operating Condition:

Test Site: EMC Chamber (3m)

Operator: Huang damping

Test Specification:

Comment:

Start of Test: 9/24/14 / 5:44:20PM

SCAN TABLE: "EN 55022 Field fin"

Start Frequency	Stop Frequency	Step Width	Detector	Meas. Time	IF Bandw.	Transducer
30.0 MHz	1.0 GHz	60.0 kHz	QuasiPeak	1.0 s	120 kHz	CBL 6112B-3

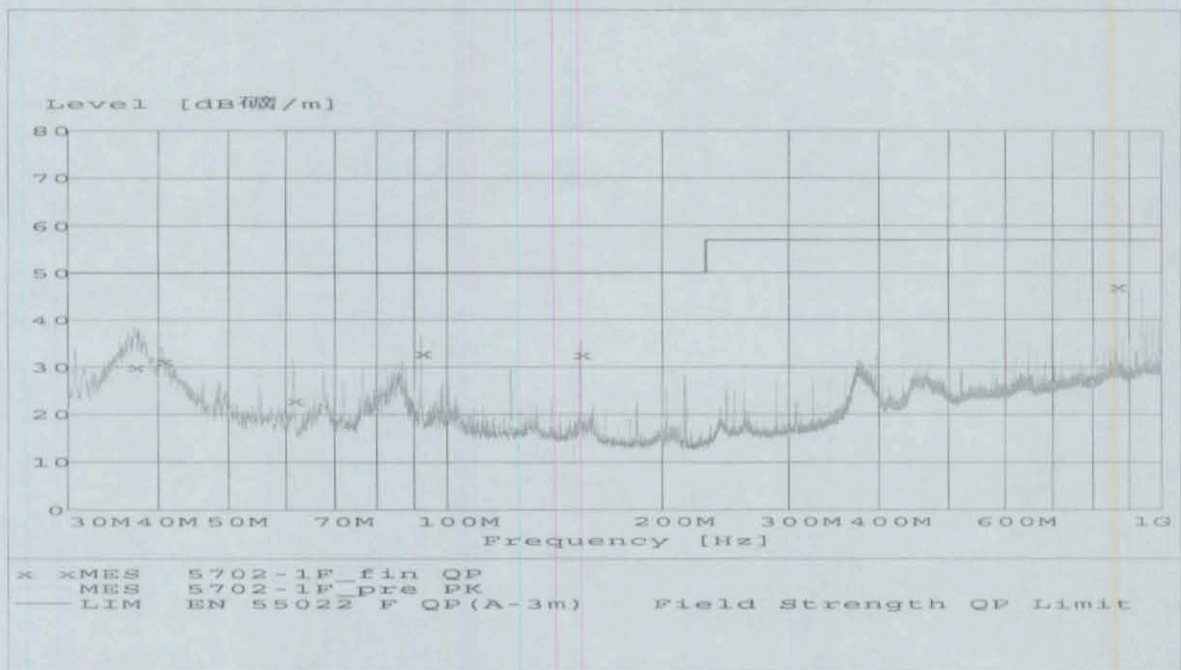

MEASUREMENT RESULT: "5702-1F_fin QP"

9/24/14 5:48PM

Frequency	Level	Transd	Limit	Margin	Height	Azimuth	Polarisation
MHz	dBµV/m		dB	dBµV/m	dB	cm	deg

37.140000	30.00	16.0	50.0	20.0	100.0	330.00	VERTICAL
40.560000	31.20	14.0	50.0	18.8	100.0	315.00	VERTICAL
61.320000	22.90	7.9	50.0	27.1	250.0	257.00	VERTICAL
92.100000	32.80	11.9	50.0	17.2	111.0	277.00	VERTICAL
153.600000	32.60	12.4	50.0	17.4	100.0	210.00	VERTICAL
864.000000	47.00	24.9	57.0	10.0	100.0	356.00	VERTICAL

— Maximum emission configuration was determined by manipulating the EUT, support equipment, interconnecting cables and varying the mode of operation and the levels in the final result of the test were recorded with the EUT running in the operating mode that maximum emission was emitted.

3.4.2 Radiated Emission Limit

Frequency (MHz)	Distance (Meters)	Field Strengths Limits (dB μ V/m) Quasi-Peak
30 ~ 230	3	50
230 ~ 1000	3	57

Note: (1) The tighter limit shall apply at the edge between two frequency bands.

(2) Distance refers to the distance in meters between the test instrument antenna and the closest point of any part of the E.U.T.

3.4.3 Operating Condition of EUT

The operation mode of EUT is same as Section 2.4.3, except the test setup.

3.4.4 Test Configuration and Procedure

EUT is tested in Semi-Anechoic Chamber. EUT is placed on a nonmetal table which is 0.8 meter above a grounded turntable. The turntable can rotate 360 degrees to determine the azimuth of the maximum emission level. EUT is set 3 meters away from the center of receiving antenna, and the antenna can move up and down from 1 to 4 meter to find out the maximum emission level. Both horizontal and vertical polarizations of the antenna are set on the test

3.5 Test Result

Pass: The overall emission level do not exceed the limits as stated in section 3.4.2.

4. Electrostatic Discharge Test

4.1 Test Standards

IEC 61000-4-2

4.2 Severity Levels and Performance Criterion

4.2.1 Severity level: Contact Discharge at $\pm 6\text{KV}$ Air Discharge at $\pm 8\text{KV}$

Level	Test Voltage Contact Discharge (KV)	Test Voltage Air Discharge (KV)
1	2	2
2	4	4
3	6	8
4	8	15
X	Special	Special

4.2.2 Performance criterion: A

4.3 Diagram of Test Setup

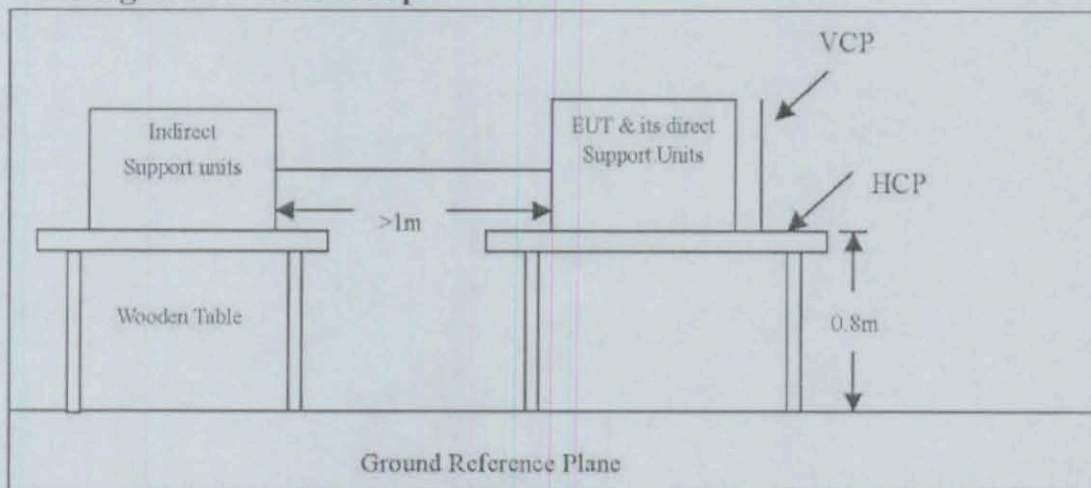

(The 470 k Ω resistors are installed per standard requirement.)

4.4 Test Equipments Used

EQP. Description
ESD Simulator

4.5 Test Description

4.5.1 Operating Condition of EUT:

The EUT is turned on during the test, and the maximum susceptible results are recorded. The data connections of the EUT and the external monitor PC is established, the health status should be received from the EUT through out the testing.

4.5.2 Test Configuration and Procedure:

Air Discharge:

— This test is done on a non-conductive surfaces. The round discharge tip of the Electrostatic Discharge simulator shall be approached as fast as possible then to touch the EUT. After each discharge, the simulator shall be removed from the EUT. The simulator is then re-triggered for a new single discharge and repeated 10 times for each pre-selected test point. This procedure shall be repeated until all the air discharge completed

Contact Discharge:

— All the procedure shall be same as air discharge, except using the acute discharge tip. The top end of the Electrostatic Discharge simulator is touch the EUT all the time when the simulator is re-triggered for a new single discharge and repeated 10 times for each pre-selected test point.

Pass and Fail Criteria: Refer to the justification criteria in section 1.5

4.6 Test Setting

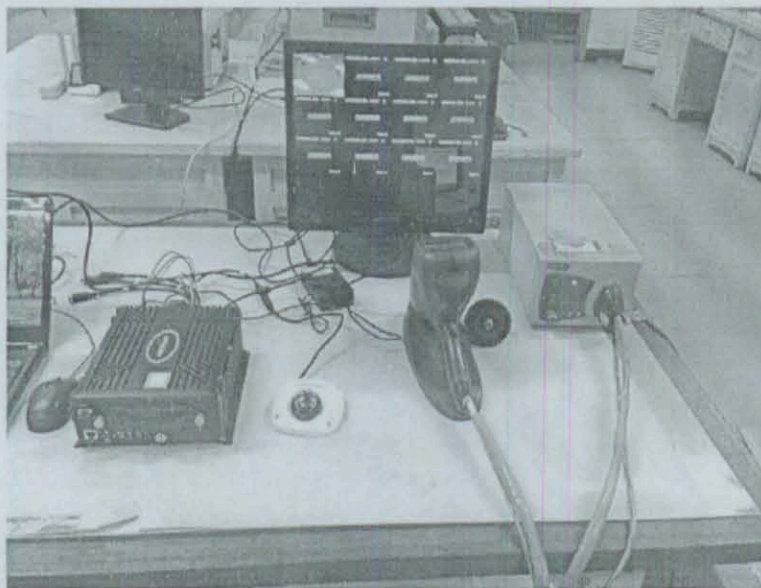

4.7 Test Result

Pass: The functions of EUT under test accord with Requirements refer to 1.5.3

5. RF Field Strength Susceptibility Test

5.1 Test Standards

IEC 61000-4-3

5.2 Severity Levels and Performance Criterion

5.2.1 Severity level:

80 MHz to 1000MHz 20V/m

1.4GHz to 2.1GHz 10V/m

2.1GHz to 2.7GHz 5V/m

Modulation : 80% AM (1kHz) for all ranges

5.3 Diagram of Test Setup

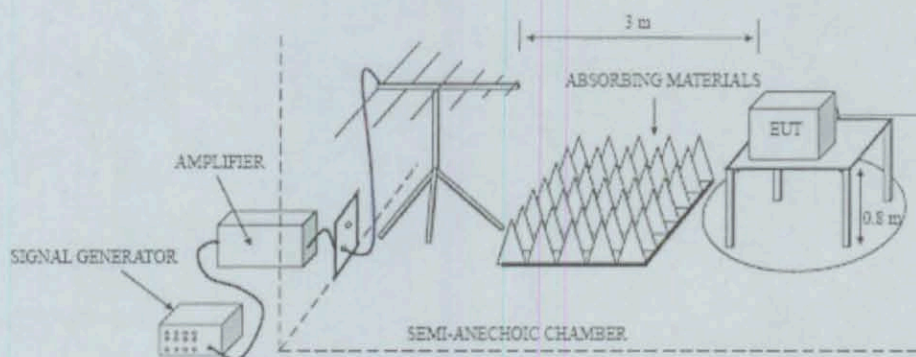

5.4 Test Equipment Used

Equipment Description
Signal Generator
AR/Power Amplifier
AR/Power Amplifier
AR/Field Probes

5.5 Test Description

5.5.1 Operating Condition of EUT

The operation mode of EUT is same as Section 4.5.1., except the test setup.

5.5.2 Configuration of Instruments

80 MHz to 1000MHz 20V/m

1.4GHz to 2.1GHz 10V/m

2.1GHz to 2.7GHz 5V/m

Modulation: 80% AM (1kHz) for all ranges

Step Size: 1% of the start and thereafter 1% of the preceding frequency value.

Dwell Time: 2Sec.

5.5.3 Test Configuration and Procedure

1. The EUT and support units were located at the edge of supporting table keep 3 meter away from transmitting antenna, it just the calibrated square area of field uniformity. And the EUT via DVR previewed on monitor which out of the chamber.
2. Adjusting the cables to be exposed to the electromagnetic field as possible.
3. Performing a Radiated Emission Scan in range of 80 to 1000MHz, 1.4GHz to 2.1GHz, 2.1GHz to 2.7GHz prior to do RS test and records the more higher emission frequencies for the reference of RS test, due to antenna effectiveness.
4. Setting the testing parameters of RS test software per IEC 61000-4-3.
5. Referring to the tested data of step 3 to performing the RS test.
6. Check the functions of EUT refer to 1.5.3
7. Changing the EUT to the other side and repeat step 3 to 6, until 4 sides of EUT were verified.
Refer to the justification criteria in section 1.6.1

5.6 Test Setting

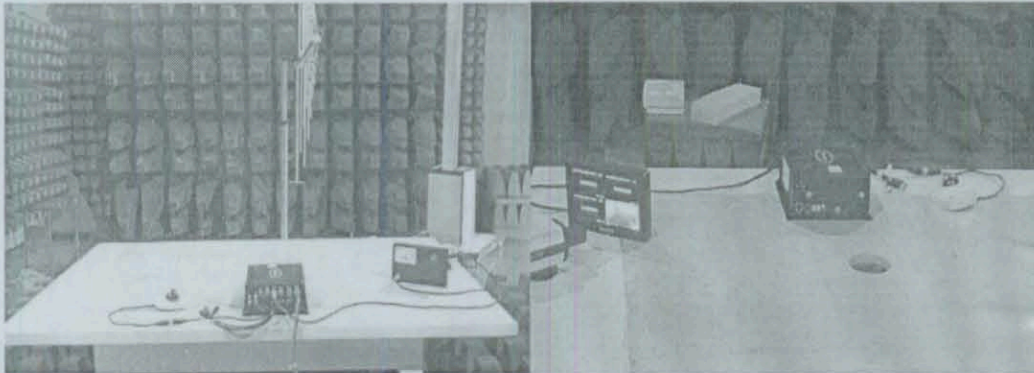

5.7 Test Result

Pass: The functions of EUT under test accord with Requirements refer to 1.5.3

6. Electrical Fast Transient/Burst Test

6.1 Test Standards

IEC 61000-4-4 clause 8

6.2 Severity Levels and Performance Criterion

6.2.1 Severity level: ± 2 kV 5/50 ns Tr/Th with 5 kHz repetition frequency, burst duration 15ms, burst period 300ms

Open Circuit Output Test Voltage $\pm 10\%$		
Level	For Power Supply Lines	
	V peak(KV)	Repetition Frequency(KHz)
1	0.5	5
2	1	5
3	2	5
4	4	2.5
x	Special	Special

6.3 Diagram of Test Setup

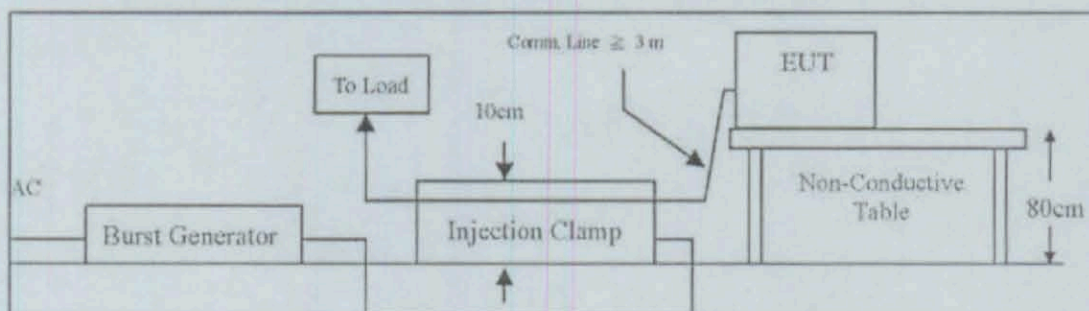
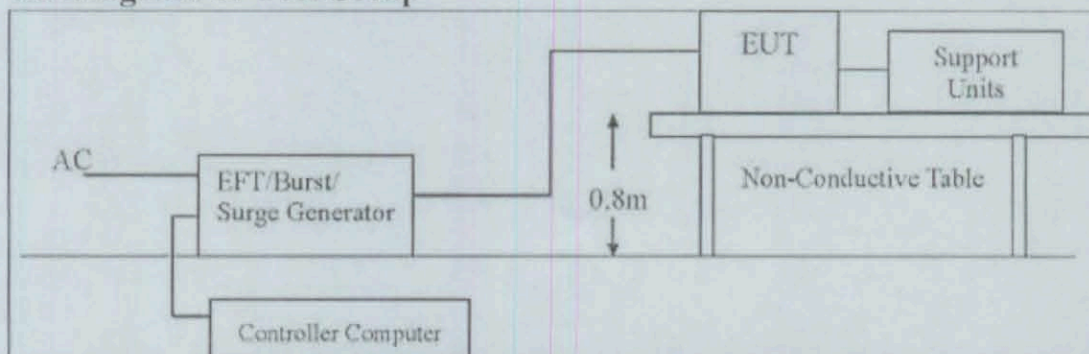

Ports for testing

Port under testing
Video & Audio output
DC 12V input

6.4 Test Equipment Used

EQP. Description

Fast Transients /Burst Generator

6.5 Test Description

6.5.1 Operating Condition of EUT:

The operation mode of EUT is same as Section 4.5.1., except the test setup.

6.5.2 Test Requirements

EUT and its simulators shall be placed 0.8m high above the ground reference plane which is a minimum 1m*1m with minimum 0.65mm thickness. This reference ground plane shall project beyond the EUT by at least 0.1m on all sides and the minimum distance between EUT and all other conductive structure, except the ground plane beneath the EUT, shall be more than 0.5m.

6.5.3 Test Configuration and Procedure

EUT is connected to coupling/decoupling network which couples the EFT signal to power input and video & audio lines. During the test, both polarities of the test voltage should be applied and the duration of the test can't be less than 1mins.

Record any performance degradation of the EUT during the test and judge the test result according to the stated performance criterion:

Test Criterion A is applied together with the following requirements refer to the justification criteria in section 1.5

6.6 Test Setting

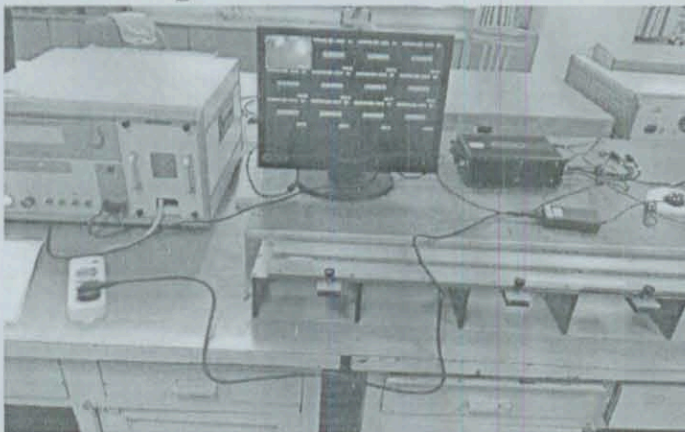

6.7 Test Result

Pass: The functions of EUT under test accord with Requirements refer to 1.5.3

7. Surge Test

7.1 Test Standards

IEC 61000-4-5 Clause 8

7.2 Severity Levels and Performance Criterion

Open circuit test voltage line to ground:

+/- 2KV 42Ω , 0.5mF

Open circuit test voltage line to line:

+/-1KV 42Ω , 0.5mF

7.3 Diagram of Test Setup

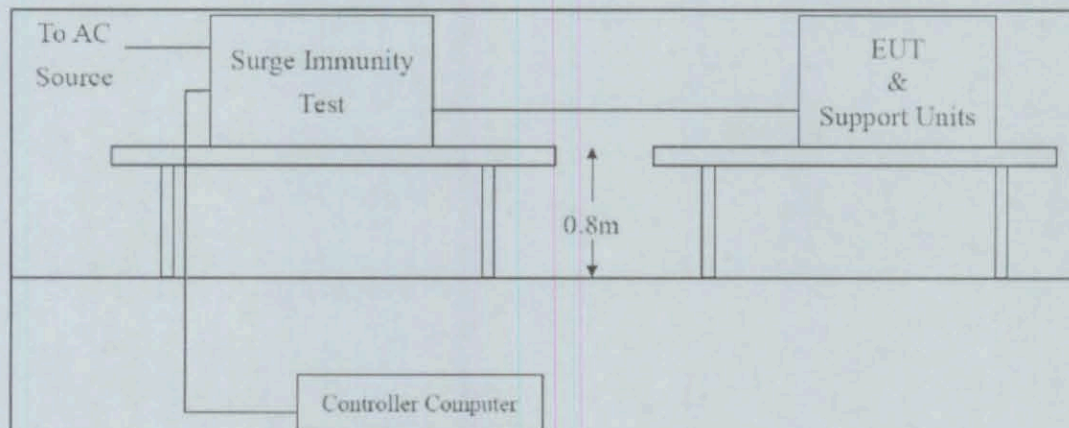

7.4 Test Equipment Used

EQP. Description
SURGE SIMULATOR
CDN

7.5 Test Description

7.5.1 Operating Condition of EUT:

The operation mode of EUT is same as Section 4.5.1., except the test setup.

7.5.2 Test Configuration and Procedure

Test Port: DC Power Port

Basic Standard: IEC/EN 61000-4-5

Requirements: ± 2 kV(Line to Ground))

± 1 kV(Line to Line)

Performance Criteria: B.

Tested by : Wei Liu

Temperature : 30C°

Relative Humidity: 43%

Pressure: 1010mbar

Test Procedure

1. The EUT and support units were located on a wooden table 0.8 m away from ground floor.
2. Injected test voltage to the EUT ports from minimum to standard request or client request.
3. Recorded the test result as shown in following table.

C-6-6 Performance and Result

Voltage Waveform: 5/50 us

Current Waveform: 8/20 us

Polarity: Positive/Negative

At least 5 positive and 5 negative (polarity) surge test

Record any performance degradation of the EUT during the test and judge the test result according to the stated performance criterion:

Test Criterion B is applied together with the following requirements refer to the justification criteria in section 1.5

7.6 Test Setting

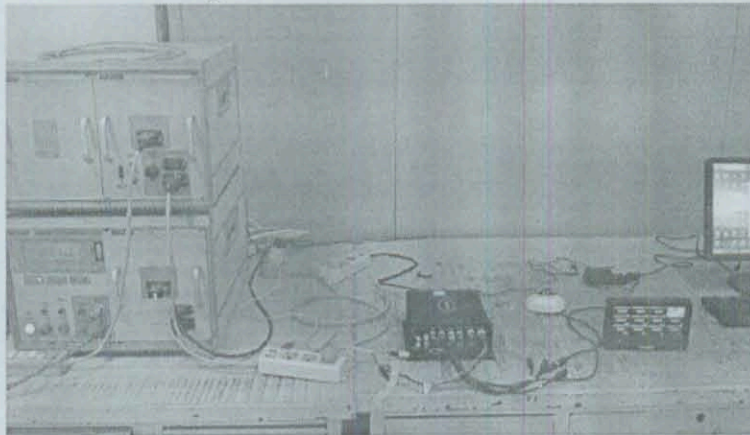

7.7 Test Result

Pass: The functions of EUT under test accord with Requirements refer to 1.5.3

8. Conducted Susceptibility Test

8.1 Test Standards

IEC 61000-4-6 Clause 8

8.2 Severity Levels and Performance Criterion

8.2.1 Severity Level: 10 Vrms (carrier voltage)

150 kHz to 80 MHz

1 kHz, 80% AM

Source impedance 150Ω

Injection Methods: CDN for all ports

8.3 Diagram of Test Setup

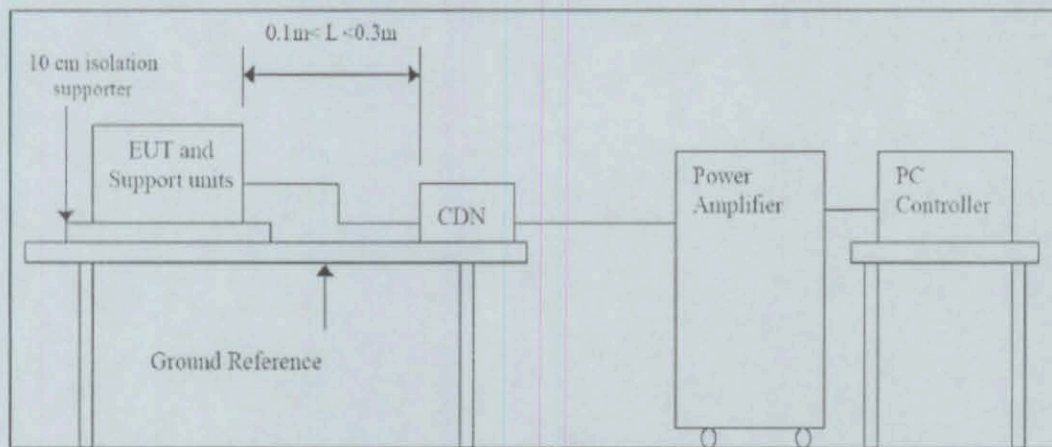

8.4 Test Equipment Used

EQP. Description
SCHAFFNER/RF Generator
CDN

8.5 Test Description

Test Condition

Port: DC Power Port and signal Port

Basic Standard: IEC/EN 61000-4-6

Requirements: 10V, with 80% AM, 1kHz Modulation.

Injection Method: CDN-M2 for DC Power Port

CDN-T4 for signal Port

Performance Criterion: A (Standard Required)

Tested by: Wei Liu

Temperature: 28C°

Humidity: 50%

Pressure: 1010mbar

Frequency Range: 0.15MHz-80MHz

Frequency Step: 1% of fundamental

Dwell Time: 3 sec

1. The EUT and support units were located at a ground reference plane with the interposition of a 0.1 m thickness insulating support and the CDN was located on GRP directly.

Set the testing parameters of CS test software as per IEC/EN 61000-4-6.

Record any performance degradation of the EUT during the test and judge the test result according to the stated performance criterion.:

Test Criterion A is applied together with the following requirements refer to the justification criteria in section 1.5

8.6 Test Setting

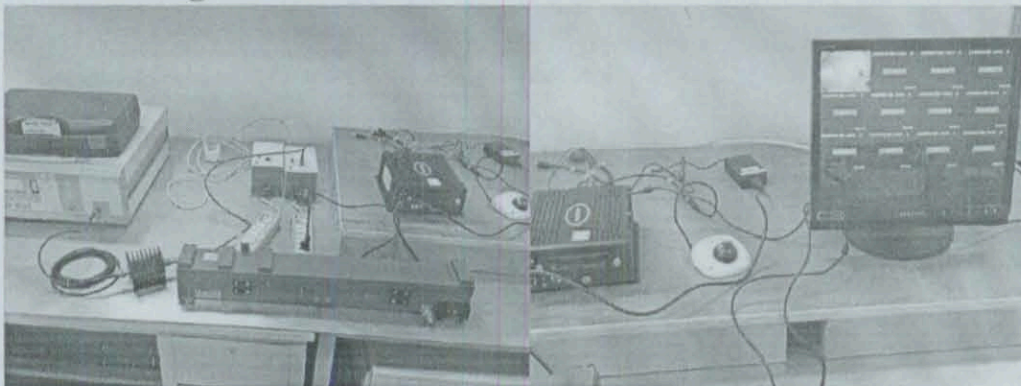

8.7 Test Result

Pass: The functions of EUT under test accord with Requirements refer to 1.5.3

9. Power supply over voltage

9.1 Test Standards

EN 50155 12.2.6

Test requirements:

$1.4U_n$, $d=0.1\text{sec}$, $D=1\text{sec}$, $R_s = 1 \Omega \pm 10\%$

Trapezoidal overvoltage according to EN50155 12.2.6 a)

9.2 Diagram of Test Setup

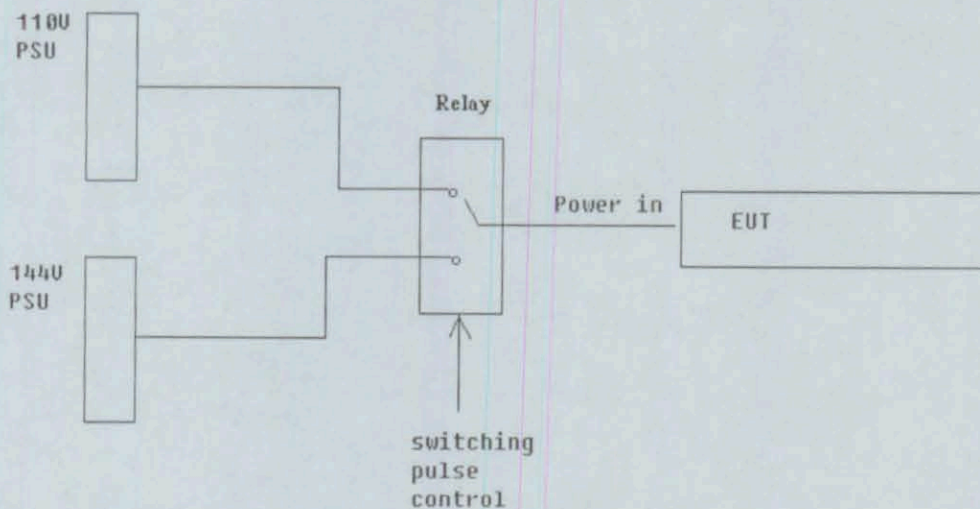

9.3 Test Configuration and Procedure

The EUT is tested with over voltage with the pulse generated by alternating switching between U_n and $1.4 U_n$ with a pulse controlled relay. Test acceptance requirements:

- No failure shall occur
- No degradation of functions has occurred.

9.4 Test Setting

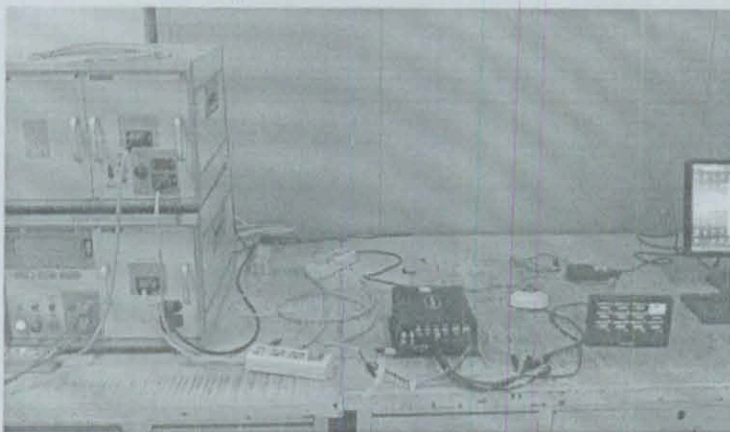

9.5 Test Result

Pass: No failure occurs and no degradation of functions has occurred.

10. Vibration Test

Base Standard : EN50155 clause 12.2.11

Test Standard : EN 61373

Equipment used in testing : Vibration Table

Random Vibration Test Parameters – 1 (Functional test)

Direction	Frequency (Hz)	ASD level (m/s^2) ² /Hz	RMS value m/s^2
Vertical	5-10	+9dB/octave	5.4
	10-100	0.190	
	100-250	-6 dB/octave	
Transverse	5-10	+9dB/octave	4.7
	10-100	0.144	
	100-250	-6 dB/octave	
Longitudinal	5-10	+9dB/octave	2.5
	10-100	0.0414	
	100-250	-6 dB/octave	
Test Time: 30 mins (Each axis)			

Random Vibration Test Parameters – 2 (Long life test)

Direction	Frequency (Hz)	ASD level (m/s^2) ² /Hz	RMS value m/s^2
Vertical	5-10	+9dB/octave	42.5
	10-100	11.83	
	100-250	-6 dB/octave	
Transverse	5-10	+9dB/octave	37
	10-100	8.96	
	100-250	-6 dB/octave	
Longitudinal	5-10	+9dB/octave	20
	10-100	2.62	
	100-250	-6 dB/octave	
Test Time: 5 hrs (Each axis)			

Definition of vibration axis

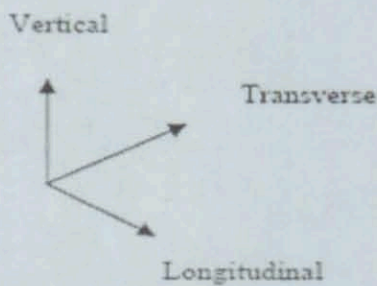

10.1 Test Procedure

1. The EUT is securely mounted on the vibration tables with the orientations that coincided with the test axis.

The control accelerometer is located on the fixture for all vibrations tests for monitoring, these data will be send back to the control monitoring software for data logging through out the testing.

2. Start the vibrations test according to Test Parameter -1 and then repeat the test for Test Parameter -2.

10.2 Acceptance Criteria

The functional test requirement is refer to section: 1.5.3

Passing Criteria:

No damage and failure should be found during and after vibration test.

Screws, nuts and other mechanical parts should be securely fixed without loose.

10.3 Test Setting

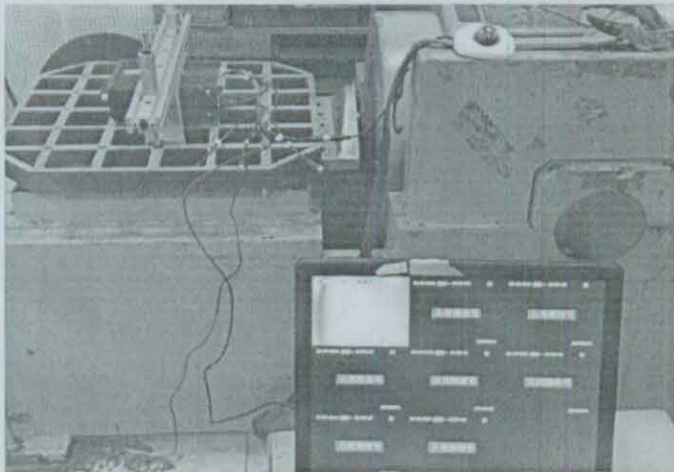

10.4 Test Result

Pass: No damage and failure occurred and the functions of EUT under test accord with Requirements refer to 1.5.3.

11. Shock Test

Base Standard : EN50155 clause 12.2.11

Test Standard : EN 61373

Wave Form : Half sine wave

Acceleration : 300m/s^2

Duration Time : 18ms

No of shock : 3 times (Each Axis)

Shock direction : \pm Longitudinal, \pm Transverse, \pm Vertical

11.1 Test Procedure:

1. The EUT is securely mounted on the vibration tables with the orientations that coincided with the test axis.
2. The control accelerometer is located on the fixture for all shock tests for monitoring these data will be send back to the control monitoring software for data logging through out the testing.
3. Start the test and repeat for each axis

11.2 Acceptance Criteria

The functional test requirement is refer to section: 1.5.3

Passing Criteria:

No damage and failure should be found during and after shock test.

Screws, nuts and other mechanical parts should be securely fixed without loose.

11.3 Test Setting:

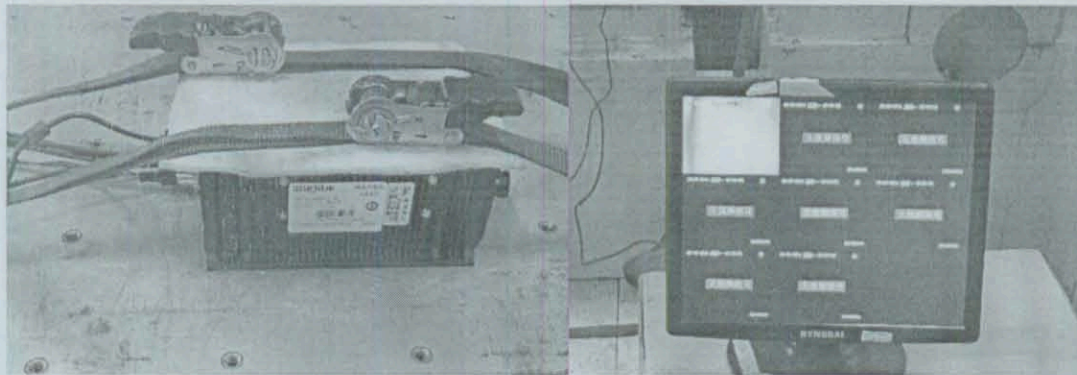

11.4 Test Result

Pass: No damage and failure occurred and the functions of EUT under test accord with Requirements refer to 1.5.3.

12. Dry Heat Test

Base Standard: EN50155 clause 12.2.4

Test Standard: EN 60068-2-2

12.1 Test Procedures

1. Perform function test (Refer to section 1.5.3.)
2. Place sample to chamber at 25°C.
3. Ramp up temperature to 70°C in 45min
4. Maintain temperature at 70°C for 8 hours
5. Perform function test
6. Ramp down to 25°C in 30min
7. Perform function test (Refer to section 1.5.3.)

12.2 Acceptance Criteria

The functional test requirement is refer to section: 1.5.3

Passing Criteria:

No damage and failure should be found during and after shock test.

Screws, nuts and other mechanical parts should be securely fixed without loose.

12.3 Test Setting



12.3 Test Result

Pass: No damage and failure occurred and the functions of EUT under test accord with Requirements refer to 1.5.3.

13. Cooling Test

Base Standard: EN50155 clause 12.2.3

Test Standard: EN 60068-2-1

13.1 Test Procedures

1. Perform function test (Refer to section 1.5.3.)
2. Place sample to chamber at 25°C.
3. To lower the temperature to -25°C in 50min
4. Maintain temperature at -25°C for 2 hours, then switch the sample on and a performance check is carried out, keeping the equipment at the low temperature for 8 hours.
5. Ramp down to 25°C in 30min
6. Perform function test (Refer to section 1.5.3.)

13.2 Acceptance Criteria

The functional test requirement is refer to section: 1.5.3

Passing Criteria:

No damage and failure should be found during and after shock test.

Screws, nuts and other mechanical parts should be securely fixed without loose.

13.3 Test Setting

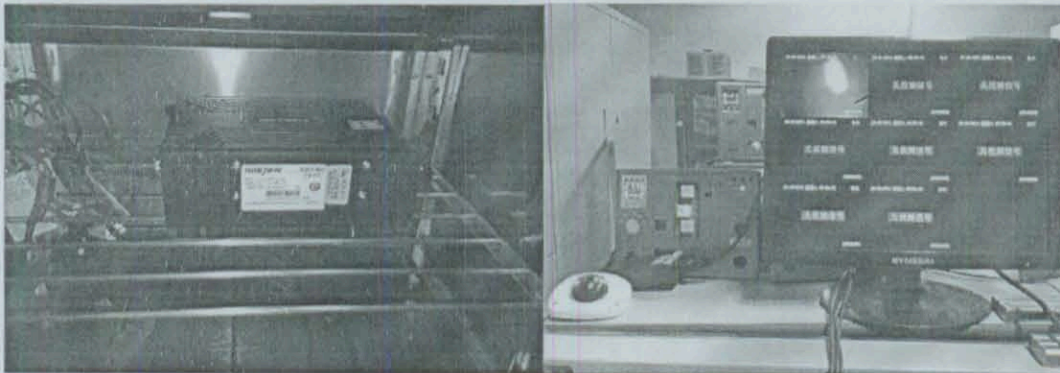

13.4 Test Result

Pass: No damage and failure occurred and the functions of EUT under test accord with Requirements refer to 1.5.3.

NOTES

1. Reports with no signet of "test report" or that of the inspect institute are all invalid.
2. Partial copy of this report is forbidden. Entire copy of the report without signet is invalid.
3. Report with no approval are invalid.
4. Altered report is invalid.
5. If any disagreement on this report, a written claim is requested to be submit to the institute within 15days on receipt of the report.
6. Generally, authorized inspection is only responsible for the samples inspected.

Address: 36#, Macheng Road, Hangzhou, China

Tel: +86 571 88366802 +86 571 88828284

Fax: +86 571 88366821

P. O. Box: 1215#, Hangzhou, China

Zip Code: 310012

E-mail: wwx@chinacptc.net

WEB: www.chinacptc.net
