

- AL** **Pershkrimi i pajisjes / Manual i instalimit**
LSN moduli 300 mA
- BG** **Описание на продукта / Инструкция за монтаж**
LSN модул 300 mA
- CZ** **Popis produktu / Instalační manuál**
Modul LSN 300 mA
- D** **Produktbeschreibung / Montageanleitung**
LSN Modul 300 mA
- DK** **Produktbeskrivelse / Installationsmanual**
LSN-modul 300 mA
- E** **Descripción del Producto / Manual de Instalación**
Módulo LSN de 300 mA
- EST** **Toote kirjeldus / Monteerimisjuhised**
LSN moodul 300 mA
- F** **Description de produit / Manuel d'installation**
Module LSN 300 mA
- FIN** **Tuotekuvaus / Asennusohjeet**
LSN-moduuli 300 mA
- GB** **Product description / Installation manual**
LSN module 300 mA
- GR** **Περιγραφή προϊόντος / Οδηγίες συναρμολόγησης**
Δομοστοιχείο LSN των 300 mA
- H** **Termékleírás / Telepítési kézikönyv**
300 mA-es LSN modul
- HR** **Opis proizvoda / Priručnik za instaliranje**
LSN modul 300 mA
- I** **Descrizione prodotto / Manuale di installazione**
Modulo LSN 300 mA
- LT** **Gaminio aprašymas / Surinkimo instrukcija**
LSN 300 mA modulis
- LV** **Izstrādājuma apraksts / Montāžas norādījumi**
LSN modulis 300 mA
- N** **Produktbeskrivelse / Monteringsinstruksoner**
LSN-modul 300 mA
- NL** **Productomschrijving / Installatiehandleiding**
LSN-module 300 mA
- P** **Descrição de Produto / Manual de Instalação**
Módulo LSN 300 mA
- PL** **Opis produktu / Instrukcja instalacji**
Moduł LSN 300 mA
- RO** **Prospecțe / Manual de Instalare**
Modul LSN de 300 mA
- RUS** **Техническое описание / Инструкция по установке**
Модуль LSN 300 mA
- S** **Produkt beskrivning / Installation manual**
LSN-modul 300 mA
- SCG** **Opis proizvoda / Instalacijski priručnik**
LSN modul 300 mA
- SLO** **Opis izdelka / Priročnik za montažo**
LSN module 300 mA
- TR** **Ürün tanımı / Kurulum kılavuzu**
LSN modülü 300 mA

LSN 0300 A
4.998.137.277

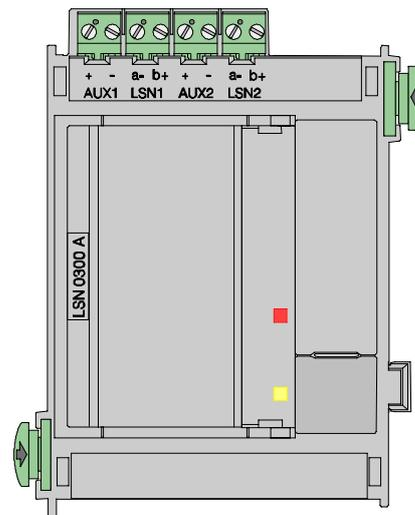

PRS 0002 A

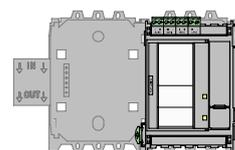

PRD 0004 A

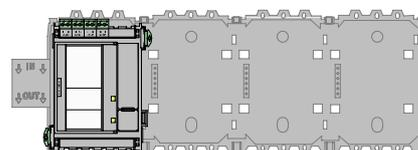

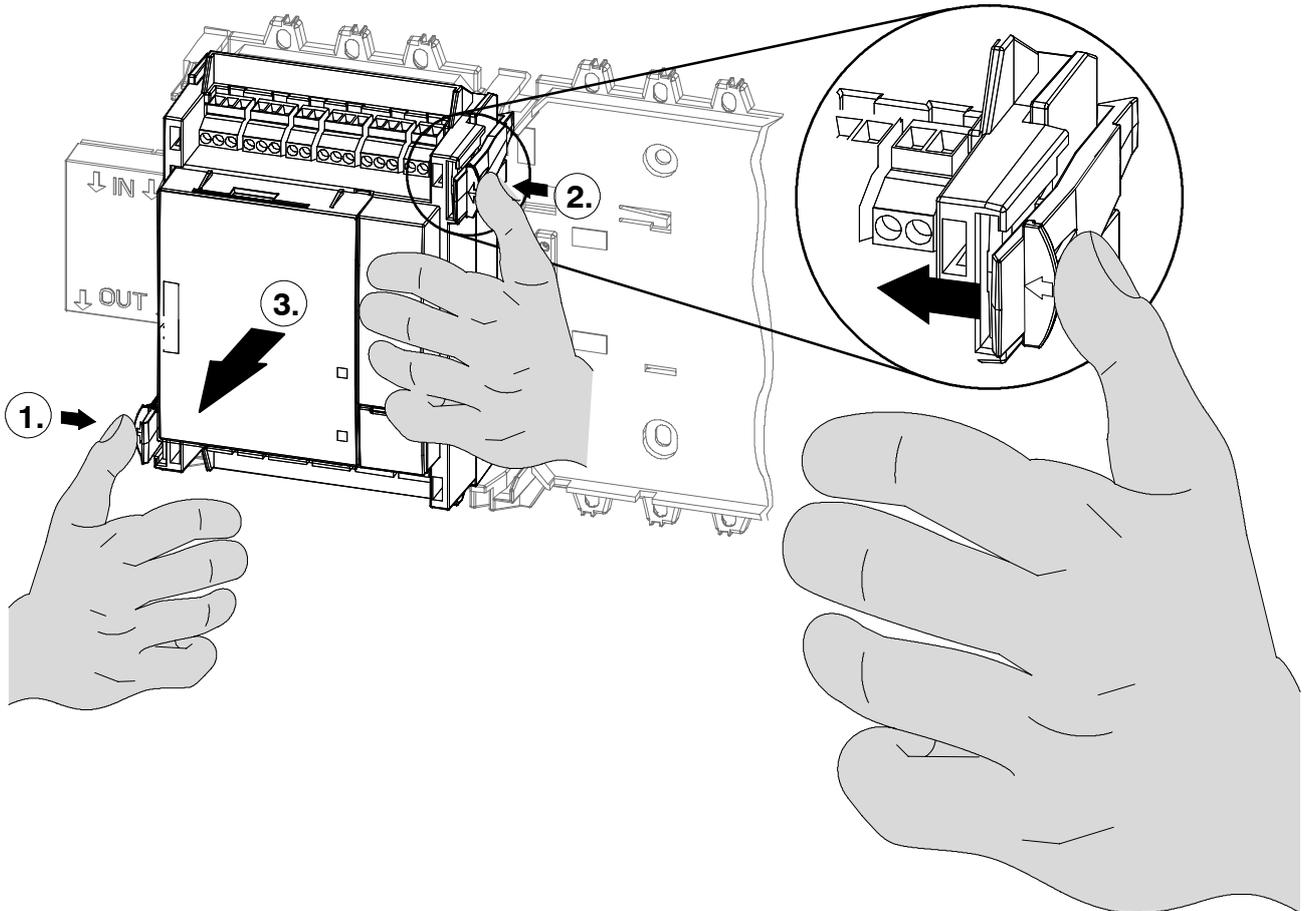
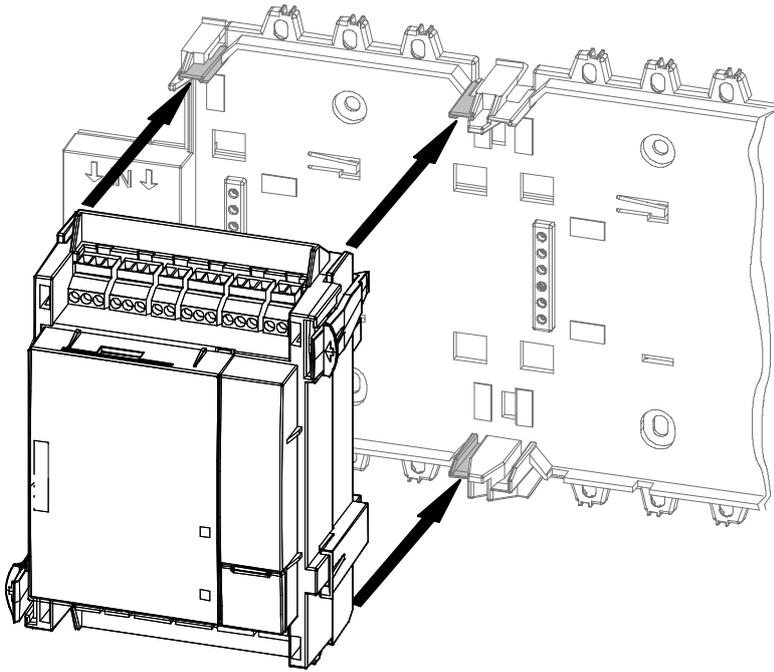



LSN 0300 A ⇒ PRS 0002 A / PRD 0004 A

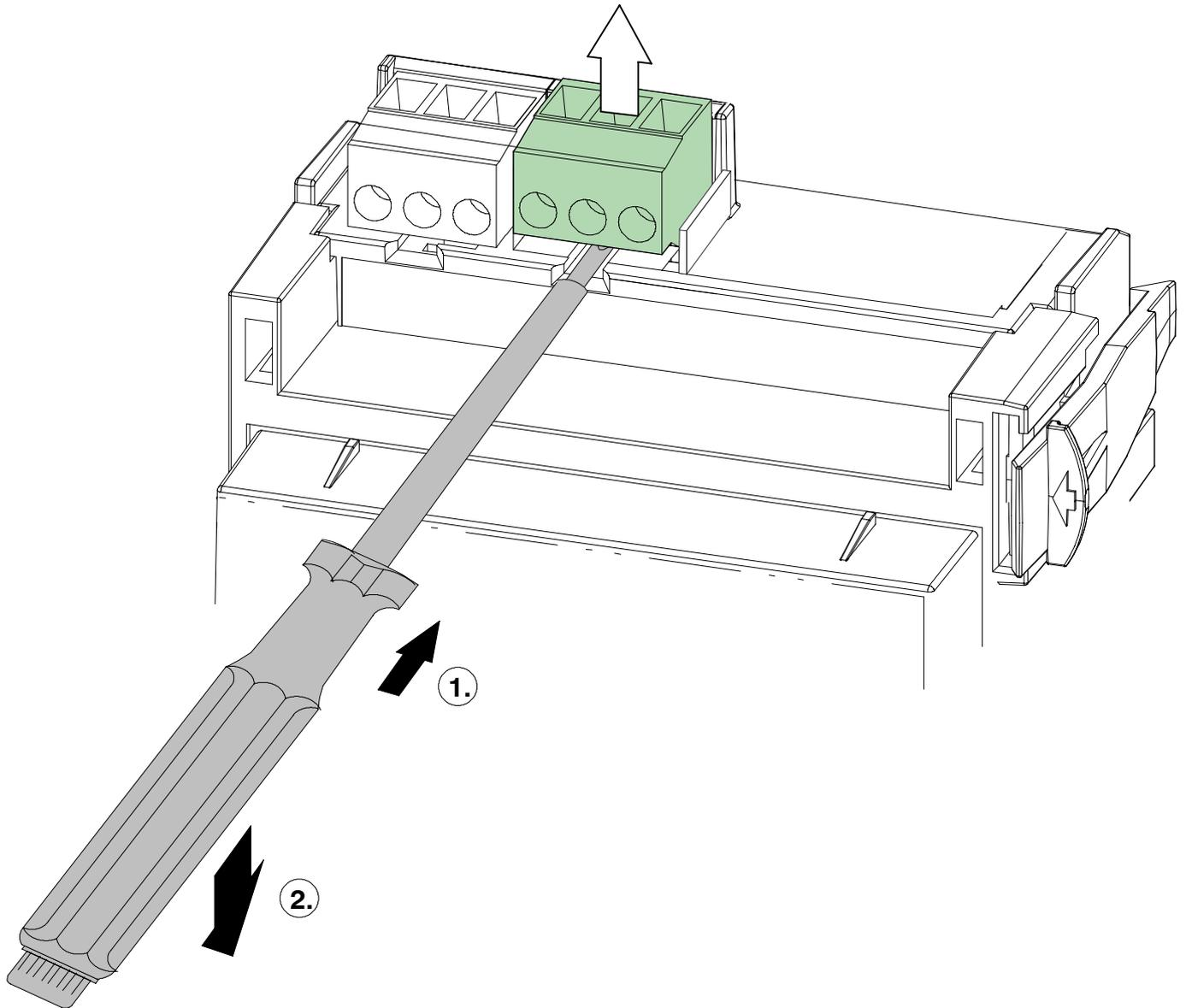

Përshkrimi i funksionit

Moduli mundëson aktivizimin e një unaze LSN me deri 254 elemente LSN_{improved} ose 127 elemente klasike LSN me një rrymë maksimale të linjës prej 300 mA.

Alokimi i terminaleve

Poz.	Legjenda	Kyçja	
		Unaza LSN	Dega LSN
1	AUX1 +	Furnizim i tensionit shtesë	Furnizim i tensionit shtesë dega 1
2	AUX1-		
3	LSN a1-	LSN a1- dalës	Dega 1 LSN a1-
4	LSN b1+	LSN b1+ dalës	Dega 1 LSN b1+
5	AUX2 +	Furnizim i tensionit shtesë***	Furnizim i tensionit shtesë dega 2
6	AUX2-		
7	LSN a2-	LSN a2- hyrës	Dega 2 LSN a2-
8	LSN b2+	LSN b2+ hyrës	Dega 2 LSN b2+

*** Vetëm për elementet ndarëse të përdorura në unazë (teknika ERT) tensioni shtesë mund të kthehet tek AUX2! [janë të përshtatshme p. sh. elementet ndarëse YBO-R/SCI]

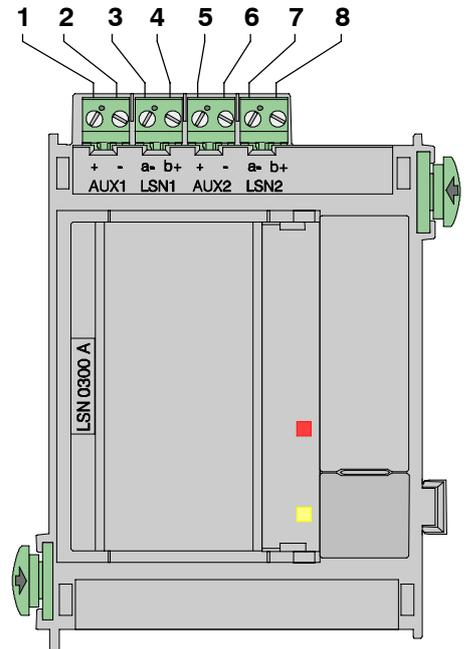

Të dhënat teknike

Elementet komanduese dhe sinjalizuese	2 dioda LED (1 x e kuqe, alarm/ 1 x e verdhë, pengesë) 1 tastë (test i LED-ve)
Tensioni në hyrje	+20 V DC . . . +30 V DC / +5 V DC ± 5 %
Tensioni bazë: - LSN-Tensioni në qetësi - LSN-Tensioni i emetimit - Furnizim shtesë AUX	30 ± 1,0 V DC 30 ± 1,0 V DC + 1,6 ± 0,15 V DC (ngritje tensioni) 28 ± 1,0 V DC
Konsumi maksimal i rrymës	1750 mA me 24 V DC
Nom. Konsumi i rrymës -Moduli - LSN - AUX	39 mA me 24 V DC 1,7 x Konsumi i rrymës i elementeve LSN 1,2 x furnizim shtesë AUX
Gjatësia e përçuesit	maks. 1600 m, në varësi të konfigurimit dhe të tipit të kabllit
Numri i elementeve LSN	maks. 127 elemente klasike LSN maks. 254 elemente klasike LSN _{improved}
Rryma e linjës LSN	maks. 300 mA, në varësi të konfigurimit dhe të tipit të kabllit,
Furnizim shtesë AUX (28 V DC)	maks. 500 mA për një unazë LSN (teknika ERT) përkatësisht 2 x maks. 500 mA për dy dega
Lloji i mbrojtjes	IP30 / IEC 60529
Standardet e sigurisë	IEC 60950 / EN 60950
Rezistenca ndaj pengesave EMV	EN 50130-4
Emetimi i pengesave EMV	EN 61000-6-3
Temperatura e lejuar e punës	-5 °C . . . 50 °C
Temperatura e lejuar e magazinimit	-20 °C . . . 60 °C
Lagështia relative e lejuar	maks. 95 % jokondensues
Materiali i kutisë dhe ngjyra	Plastik ABS, (UL94 V-0), gjysmë i marrtë, antracit, RAL 7016
Përmasat (L x GJ x TH)	rrreth 127 x 96 x 60 mm
Pesha	rrreth 225 g

Функционално описание

Модулът дава възможност за присъединяване на линия от локална мрежа за сигурност (LSN) с до 254 LSN_{improved} - елемента или 127 класически LSN - елемента, при максимален ток в линията от 300 mA.

Свързване на клемите

Клема	Означение	Предназначение	
		LSN контур	LSN льчове
1	AUX1 +	Допълнително захранващо напрежение	Допълнително захранващо напрежение, Льч 1
2	AUX1 -		
3	LSN a1-	LSN a1- изходящ	Льч 1 LSN a1-
4	LSN b1+	LSN b1+ изходящ	Льч 1 LSN b1+
5	AUX2 +	Допълнително захранващо напрежение***	Допълнително захранващо напрежение, Льч 2
6	AUX2 -		
7	LSN a2-	LSN a2- входящ	Льч 2 LSN a2-
8	LSN b2+	LSN b2+ входящ	Льч 2 LSN b2+

*** Допълнителното захранващо напрежение трябва да се подаде обратно на AUX2 само при монтирани в контура YBO-R/SCI разделителни елементи (ERT техника)! [подходящи са, напр., YBO-R/SCI разделителни елементи]

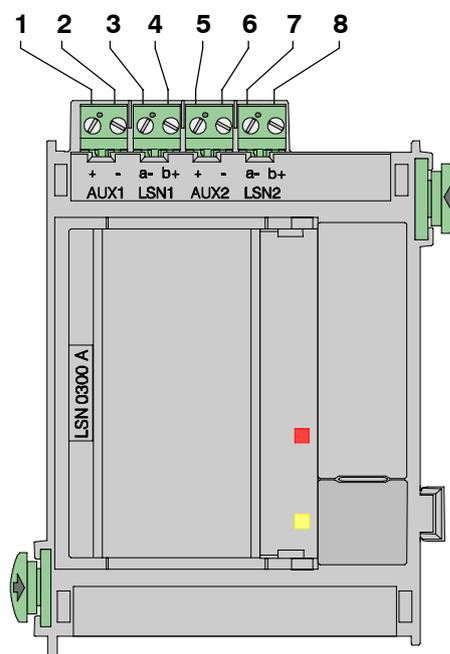

Технически данни

Елементи за индикация и управление	2 светодиодни индикатора (1 червен, тревога / 1 жълт, повреда) 1 бутон (проверка на LED индикаторите)
Входно напрежение	+20 V DC . . . +30 V DC / +5 V DC $\pm 5\%$
Изходно напрежение: - Остатъчно напрежение на LSN - Напрежение на предаване на LSN - Допълнително захранване AUX	30 \pm 1,0 V DC 30 \pm 1,0 V DC + 1,6 \pm 0,15 V DC (диапазон на колебание на напрежението) 28 \pm 1,0 V DC
Максимална консумация на ток	1750 mA при 24 V DC
Ном. консумация на ток: - Модул - LSN - AUX	39 mA при 24 V DC 1,7 x консумацията на ток на LSN елементите 1,2 x допълнителното захранване на AUX
Дължина на линията	макс. 1600 m, в зависимост от конфигурацията и типа на кабелите
Брой LSN елементи	макс. 127 класически LSN елемента макс. 254 LSN _{improved} елемента
Ток в LSN линията	макс. 300 mA, в зависимост от конфигурацията и типа на кабелите,
Допълнително захранване AUX (28 V DC)	макс. 500 mA при LSN контур (ERT техника) съотв. 2 x макс. 500 mA при 2 льча
Степен на защита	IP30 / IEC 60529
Стандарти за безопасност	IEC 60950 / EN 60950
Устойчивост на EMC	EN 50130-4
Излъчване на EMC	EN 61000-6-3
Допустима работна температура	-5 °C . . . 50 °C
Допустима температура на съхранение	-20 °C . . . 60 °C
Допустима относителна влажност	макс. 95 % без кондензация
Материал и цвят на корпуса	Пластмаса ABS, (UL94 V-0), блестящ матиран антрацитно черен, RAL 7016
Габарити (В x Ш x Д)	прибл. 127 x 96 x 60 mm
Тегло	прибл. 225 g

Popis funkce

Modul umožňuje připojení kruhového vedení LSN až s 254 prvky LSN nebo se 127 klasickými prvky LSN při maximálním linkovém proudu 300 mA.

Připojení svorek

Pol.	Označení	Připojení	
		Kruh LSN	Vteř LSN
1	AUX1 +	Přídavný zdroj napětí	Přídavný zdroj napětí pro 1. vteř
2	AUX1 -		
3	LSN a1-	Odchozí LSN a1-	Vteř 1 LSN a1-
4	LSN b1+	Odchozí LSN b1+	Vteř 1 LSN b1+
5	AUX2 +	Přídavný zdroj napětí***	Přídavný zdroj napětí pro 2. vteř
6	AUX2 -		
7	LSN a2-	Přichodí LSN a2-	Vteř 2 LSN a2-
8	LSN b2+	Přichodí LSN b2+	Vteř 2 LSN b2+

*** Přídavné napětí k AUX2 lze vést pouze s dličními prvky použitými v kruhu (technika ERT)! [vhodné jsou nap. dliční prvky YBO-R/SC1]

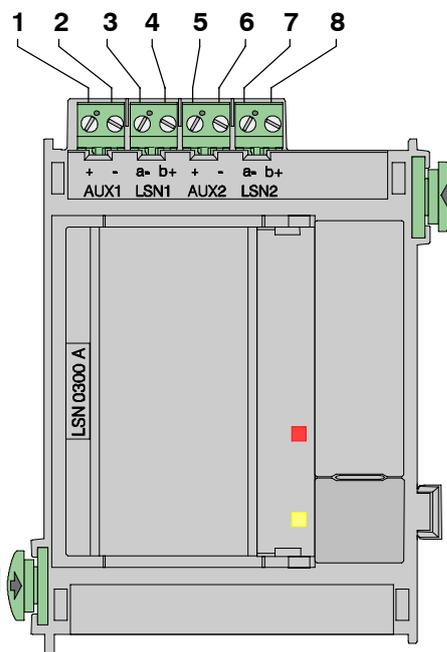

Technická data

Obslužné prvky a indikátory	2x LED (1x červená, poplach / 1x žlutá, porucha) 1 tlačítko (test LED)
Vstupní napětí	+20 V DC . . . +30 V DC / +5 V DC ±5 %
Výstupní napětí: - klidové napětí LSN - vysílací napětí LSN - přídavné napájení AUX	30 ± 1,0 V DC 30 ± 1,0 V DC + 1,6 ± 0,15 V DC (pomr napětí) 28 ± 1,0 V DC
Maximální odběr proudu	1750 mA při 24 V DC
Nom. odběr proudu: - modul - LSN - AUX	39 mA při 24 V DC 1,7 x odběr proudu prvek LSN 1,2 x přídavné napájení AUX
Délka vodiče	max. 1600 m, závisí na konfiguraci a typu kabelu
Počet prvků LSN	max. 127 klasických prvků LSN max. 254 prvků LSN
linkový proud LSN	max. 300 mA, závisí na konfiguraci a typu kabelu,
Přídavné napětí AUX (28 V DC)	max. 500 mA u kruhu LSN (technika ERT), příp. 2 x max. 500 mA u 2 vteř
Krytí	IP30 / IEC 60529
Bezpečnostní standardy	IEC 60950 / EN 60950
Odolnost proti rušení EMV	EN 50130-4
Rušivé vysílání EMV	EN 61000-6-3
Připustná provozní teplota	-5 °C . . . 50 °C
Připustná skladovací teplota	-20 °C . . . 60 °C
Připustná relativní vlhkost	Max. 95 % nekondenzující
Materiál krytu a barva	Plast ABS, (UL94 V-0), jemná matná antracitová, RAL 7016
Rozměry (V x Š x T)	cca 127 x 96 x 60 mm
Hmotnost	cca 225 g

Funktionsbeschreibung

Das Modul ermöglicht die Anschaltung eines LSN-Ringes mit bis zu 254 LSN_{improved} - Elementen oder 127 klassischen LSN - Elementen, bei einem maximalen Linienstrom von 300 mA.

Klemmenbelegung

Pos.	Beschriftung	Anschluß	
		LSN-Ring	LSN-Stich
1	AUX1 +	Zusatzspannungsversorgung	Zusatzspannungsversorgung Stich 1
2	AUX1 -		
3	LSN a1-	LSN a1- gehend	Stich 1 LSN a1-
4	LSN b1+	LSN b1+ gehend	Stich 1 LSN b1+
5	AUX2 +	Zusatzspannungsversorgung***	Zusatzspannungsversorgung Stich 2
6	AUX2 -		
7	LSN a2-	LSN a2- kommend	Stich 2 LSN a2-
8	LSN b2+	LSN b2+ kommend	Stich 2 LSN b2+

*** Nur bei im Ring eingesetzten Trennelementen (ERT-Technik) darf die Zusatzspannung zu AUX2 zurückgeführt werden!
[geeignet sind z.B. YBO-R/SCI-Trennelemente]

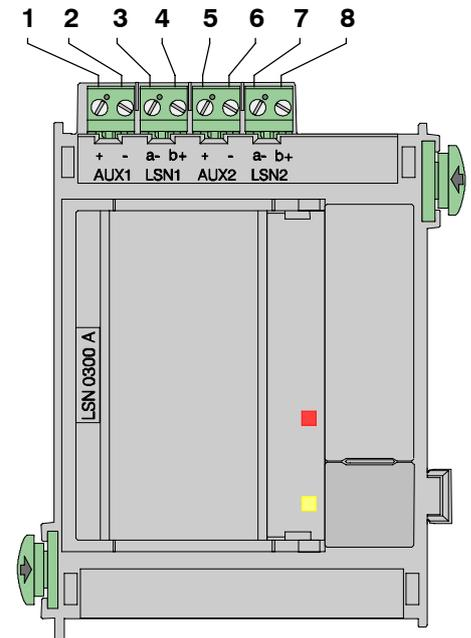

Technische Daten

Bedien- und Anzeigeelemente	2 LEDs (1 x rot, Alarm/ 1 x gelb, Störung) 1 Taste (LED-Test)
Eingangsspannung	+20 VDC . . . +30 V DC / +5 VDC ± 5 %
Ausgangsspannung	
- LSN-Ruhespannung	30 ± 1,0 V DC
- LSN-Sendespannung	30 ± 1,0 V DC + 1,6 ± 0,15 V DC (Spannungshub)
- Zusatzversorgung AUX	28 ± 1,0 V DC
Maximale Stromaufnahme	1750 mA bei 24 V DC
Nominale Stromaufnahme:	
- Modul	39 mA bei 24 V DC
- LSN	1,7 x Stromaufnahme der LSN-Elemente
- AUX	1,2 x Zusatzversorgung AUX
Leitungslänge	max. 1600 m, abhängig von Konfiguration und Kabeltyp
Anzahl LSN Elemente	max. 127 klassische LSN Elemente max. 254 LSN _{improved} Elemente
Linienstrom LSN	max. 300 mA, abhängig von Konfiguration und Kabeltyp
Zusatzversorgung AUX (28 V DC)	max. 500 mA bei einem LSN-Ring (ERT-Technik) bzw. 2 x max. 500 mA bei 2 Stichen
Schutzart	IP30 / IEC 60529
Sicherheitsstandards	IEC 60950 / EN 60950
EMV-Störfestigkeit	EN 50130-4
EMV-Störaussendung	EN 61000-6-3
Zulässige Betriebstemperatur	-5 °C . . . 50 °C
Zulässige Lagertemperatur	-20 °C . . . 60 °C
Zulässige relative Feuchte	max. 95 % nicht kondensierend
Gehäusematerial und Farbe	ABS Kunststoff, (UL94 V-0), seidenmatt anthrazit, RAL 7016
Abmessungen (H x B x T)	ca. 127 x 96 x 60mm
Gewicht	ca. 225 g

Funktionsbeskrivelse

Modulet gør det muligt at aktivere en LSN-ring med op til 254 LSN_{improved} - elementer eller 127 almindelige LSN - elementer med en maksimal linjestrøm på 300 mA.

Klemmebelægning

Pos.	Mærkning	Tilslutning	
		LSN-ring	LSN-stik
1	AUX1 +	Supplerende spændingsforsyning	Supplerende spændingsforsyning, stik 1
2	AUX1 -		
3	LSN a1-	LSN a1- gående	Grenstub 1 LSN a1-
4	LSN b1+	LSN b1+ gående	Grenstub 1 LSN b1+
5	AUX2 +	Supplerende spændingsforsyning***	Supplerende spændingsforsyning, stik 2
6	AUX2 -		
7	LSN a2-	LSN a2- kommende	Grenstub 2 LSN a2-
8	LSN b2+	LSN b2+ kommende	Grenstub 2 LSN b2+

*** Kun ved de i ring indsatte separatorer (ERT-teknik) må den supplerende spændingsforsyning føres tilbage til AUX2! [egnet er f.eks. YBO-R/SCI-separatorer]

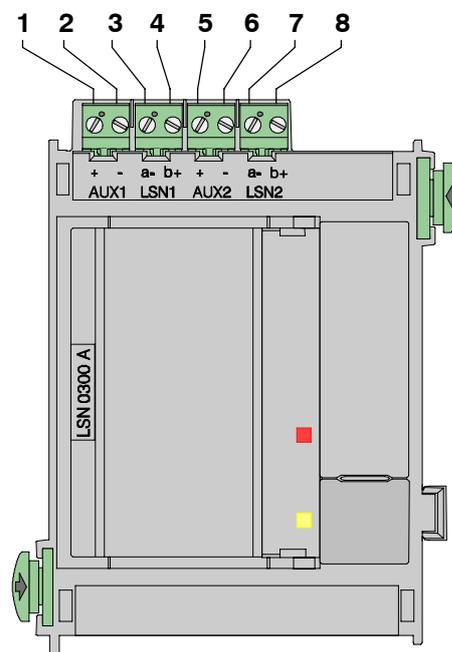

Tekniske data

Betjenings- og indikatorelementer	2 LED'er (1 x rød, alarm / 1 x gul, fejl) 1 tast (LED-test)
Indgangsspænding	+20 V DC . . . +30 V DC / +5 V DC ± 5 %
Udgangsspænding: - LSN-hvilespænding - LSN-sendespænding - Suppleringsforsyning AUX	30 ± 1,0 V DC 30 ± 1,0 V DC + 1,6 ± 0,15 V DC (spændingsslag) 28 ± 1,0 V DC
Maks. strømforbrug	1750 mA ved 24 V DC
Nom. strømforbrug: - modul - LSN - AUX	39 mA ved 24 V DC 1,7 x LSN-elementernes strømforbrug 1,2 x suppleringsforsyning AUX
Ledningslængde	maks. 1600 m, afhængigt af konfiguration og kabeltype
Antal LSN-elementer	maks. 127 almindelige LSN-elementer maks. 254 LSN _{improved} elementer
Linjestrøm LSN	maks. 300 mA, afhængigt af konfiguration og kabeltype,
Suppleringsforsyning AUX (28 V DC)	maks. 500 mA ved en LSN-ring (ERT-teknik) hhv. 2 x maks. 500 mA ved 2 stik
Beskyttelsestype	IP30/IEC 60529
Sikkerhedsstandarderne	IEC 60950 / EN 60950
EMC - elektromagnetisk kompatibilitet	EN 50130-4
EMC - emission	EN 61000-6-3
Tilladt driftstemperatur	-5 °C . . . 50 °C
Tilladt opbevaringstemperatur	-20 °C . . . 60 °C
Tilladt relativ luftfugtighed	maks. 95 % ikke-kondenserende
Kabinetmateriale og -farve	ABS-kunststof, (UL94 V-0), silkemat koksgrå, RAL 7016
Dimensioner (H x B x D)	ca. 127 x 96 x 60 mm
Vægt	ca. 225 g

Descripción de las funciones

El módulo permite conectar un lazo LSN con hasta 254 elementos LSN *improved* ó 127 elementos LSN clásicos, con una corriente de línea máxima de 300 mA.

Conexión de los bornes

Pos.	Nombre	Conexión	
		Lazo LSN	Ramal LSN
1	AUX1 +	Alimentación de tensión auxiliar	Alimentación de tensión auxiliar del ramal 1
2	AUX1 -		
3	LSN a1-	LSN a1- entrada	Ramal 1 LSN a1-
4	LSN b1+	LSN b1+ entrada	Ramal 1 LSN b1+
5	AUX2 +	Alimentación de tensión auxiliar***	Alimentación de tensión auxiliar del ramal 2
6	AUX2 -		
7	LSN a2-	LSN a2- salida	Ramal 2 LSN a2-
8	LSN b2+	LSN b2+ salida	Ramal 2 LSN b2+

*** ¡Sólo se puede reconducir la tensión auxiliar a AUX2 con aisladores de la línea de alimentación auxiliar (tecnología ERT) !
[los aisladores YBO-R/SCI, por ejemplo, son adecuados]

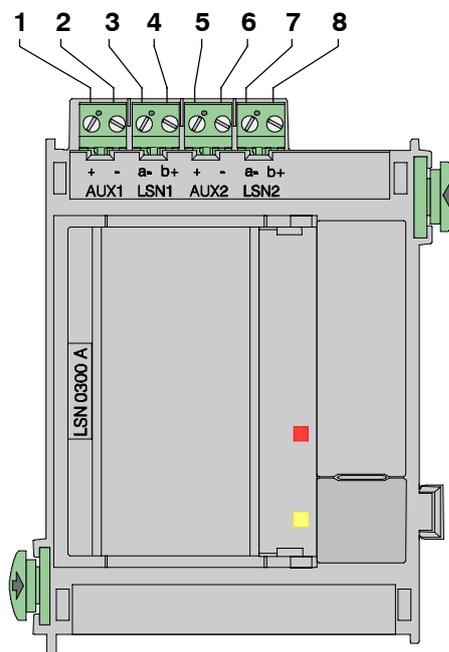

Datos técnicos

Elementos de manejo y de indicación	2 LED (1 x rojo, alarma / 1 x amarillo, problema) 1 tecla (Prueba de LED)
Tensión de entrada	+20 V CC . . . +30 V CC / +5 V CC \pm 5 %
Tensión de salida: - Tensión de reposo del LSN - Tensión de transmisión del LSN - Alimentación auxiliar AUX	30 \pm 1,0 V CC 30 \pm 1,0 V CC + 1.6 \pm 0,15 V CC (sin tensión) 28 \pm 1,0 V CC
Consumo de corriente máxima	1750 mA con 24 V CC
Consumo de corriente nom.: Módulo - LSN - AUX	39 mA con 24 V CC 1,7 x consumo de corriente de los elementos 1,2 x alimentación auxiliar AUX
Longitud del lazo	máx. 1600 m, en función de la configuración y el tipo de cable
Número de elementos LSN	máx. 127 elementos LSN clásicos máx. 254 elementos LSN _{improved}
Corriente de línea LSN	máx. 300 mA, en función de la configuración y el tipo de cable
Alimentación auxiliar AUX (28 V CC)	máx. 500 mA con lazo LSN (Técnica ERT) p. ejem. 2 x máx. 500 mA con 2 ramales
Tipo de protección	IP30 / IEC 60529
Estándares de seguridad	IEC 60950 / EN 60950
Resistencia a interferencias EMV	EN 50130-4
Emisión de interferencias EMV	EN 61000-6-3
Temperatura de operación permitida	-5 °C. . . 50 °C
Temperatura de almacenaje permitida	-20 °C. . . 60 °C
Humedad relativa permitida	máx. 95 % sin condensación
Material de la carcasa y color	ABS plástico, (UL94 V-0), mate sedoso antracita, RAL 7016
Dimensiones	aprox. 127 x 96 x 60mm (altura x anchura x profundidad)
Peso	aprox. 225 g

Funktsioonikirjeldus

Moodul võimaldab lülitada 254 LSN_{improved} [täiustatud] - elemendiga või 127 klassikalise LSN - elemendiga LSN-ringliini maksimaalse 300 mA liinipingega.

Klemmikate

Pos.	Märgistus	Ühendus	
		LSN-ringliin	LSN-radiaal
1	AUX1 +	Lisatoitepinge	Lisatoitepinge 1. radiaal
2	AUX1 -		
3	LSN a1-	LSN a1- käigus	1 LSN a1- radiaal
4	LSN b1+	LSN b1+ käigus	1 LSN b1+ radiaal
5	AUX2 +	Lisatoitepinge***	Lisatoitepinge 2. radiaal
6	AUX2 -		
7	LSN a2-	LSN a2- järgnevalt	2 LSN a2- radiaal
8	LSN b2+	LSN b2+ järgnevalt	2 LSN b2+ radiaal

*** Ainult ringliinis rakendatavate eralduselementide korral (ERT-meetod) tohib lisapinget AUX2 korral tagasi suunata! [kohased on nt. YBO-R/SCI-eralduselemendid]

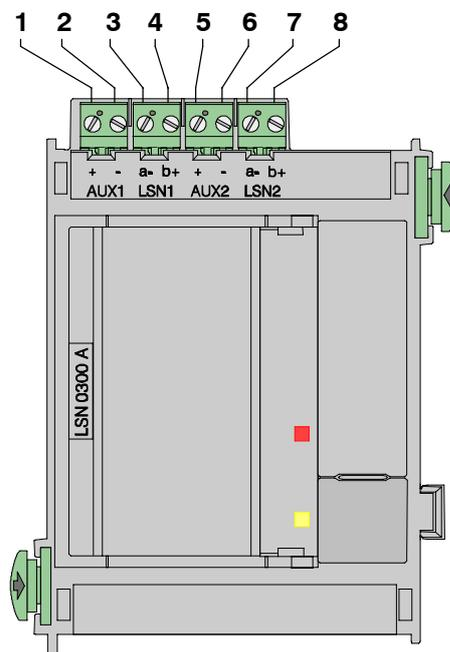

Tehnilised andmed

Käsitsemis- ja näiduelemendid	2 LED-i (1 x punane, alarm/ 1 x kollane, rike) 1 klahv (LED-test)
Sisendpinge	+20 V DC . . . +30 V DC / +5 V DC ± 5 %
Väljundpinge: - LSN-puhkepinge - LSN-saatmispinge - Lisa elektrivarustus AUX	30 ± 1,0 V DC 30 ± 1,0 V DC + 1,6 ± 0,15 V DC (pingeplatvorm) 28 ± 1,0 V DC
Maksimaalse pinge registreerimine	1750 mA 24 V AV juures
Nom. pinge registreerimine: - Moodul - LSN - AUX	39 mA 24 V AV juures 1,7 x LSN-elementi pinge registreerimine 1,2 x AUX lisaelektrivarustus
Kaabli pikkus	maks. 1600 m, sõltuvalt konfiguratsioonist ja kaabli tüübist
LSN elementide arv	maks. 127 klassikalist LSN elementi maks. 254 LSN _{improved} elementi
Liinipinge LSN	maks. 300 mA, sõltuvalt konfiguratsioonist ja kaablitüübist,
AUX lisaelektrivarustus (28 V AV)	maks. 500 mA LSN-ringliini puhul (ERT-tehnika) või 2 x maks. 500 mA bei 2 radiaali puhul
Kaitseliik	IP30 / IEC 60529
Turvalisusstandardid	IEC 60950 / EN 60950
EMV häiringukindlus	EN 50130-4
EMV müra emissioon	EN 61000-6-3
Lubatud töötemperatuur	-5 °C . . . 50 °C
Laagri lubatud temperatuur	-20 °C . . . 60 °C
Lubatud suhteline õhuniiskus	max 95 % mittekondenseeruv
Kattematerjal ja -värv	ABS kunstmaterjal, (UL94 V-0), siidmatt antratsiit, RAL 7016
Mõõtmised (H x B x T)	ca 127 x 96 x 60mm
Kaal	ca 225 g

Description du fonctionnement

Ce module permet de connecter un anneau LSN comportant jusqu'à 254 éléments LSN_{improved} ou 127 éléments LSN classiques, à un courant secteur maximal de 300 mA.

Brochage

Pos.	Marquage	Raccordement	
		Anneau LSN	Tronçon LSN
1	AUX1 +	Alimentation électrique supplémentaire	Alimentation électrique supplémentaire tronçon 1
2	AUX1 -		
3	LSN a1-	LSN a1- sortant	Tronçon 1 LSN a1-
4	LSN b1+	LSN b1+ sortant	Tronçon 1 LSN b1+
5	AUX2 +	Alimentation électrique supplémentaire***	Alimentation électrique supplémentaire tronçon 2
6	AUX2 -		
7	LSN a2-	LSN a2- entrant	Tronçon 2 LSN a2-
8	LSN b2+	LSN b2+ entrant	Tronçon 2 LSN b2+

*** La tension supplémentaire doit être amenée sur AUX2 uniquement lorsque l'élément de coupe est utilisé dans l'anneau (technique ERT) [les éléments de coupe YBO-R/SCI sont par exemple parfaitement adaptés].

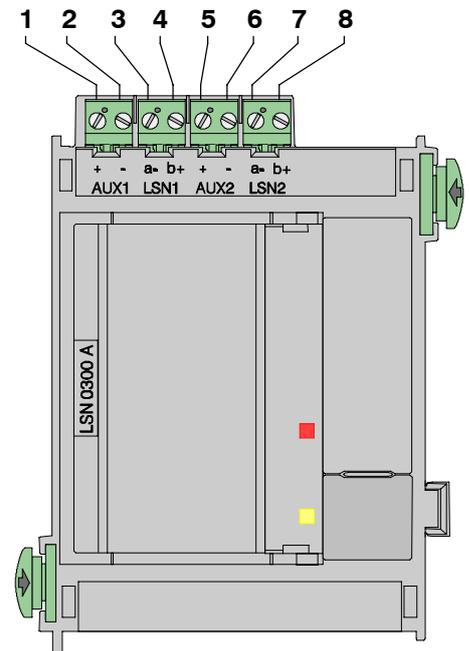

Caractéristiques techniques

Éléments de commande et d'affichage	2 voyants DEL (1x rouge, alarme / 1x jaune, défaillance) 1 bouton (test des voyants DEL)
Tension d'entrée	+20 V c.c. . . +30 V c.c. / +5 V c.c. ±5 %
Tension de sortie: - Tension de repos LSN - Tension d'émission LSN - Alimentation supplémentaire AUX	30 ± 1,0 V c.c. 30 ± 1,0 V c.c. + 1,6 ± 0,15 V c.c. (tension) 28 ± 1,0 V c.c.
Consommation maximale	1750 mA à 24 V c.c.
Consommation nominale: - module - LSN - AUX	39 mA à 24 V c.c. 1,7 x consommation des éléments LSN 1,2 x alimentation supplémentaire AUX
Longueur de câble	max. 1600 m, en fonction de la configuration et du type de câble
Nombre d'éléments LSN	max. 127 éléments LSN classiques max. 254 éléments LSN _{improved}
Courant secteur LSN	max. 300 mA, en fonction de la configuration et du type de câble,
Alimentation supplémentaire AUX (28 V c.c.)	max. 500 mA avec un anneau LSN (technique ERT) ou 2 x max. 500 mA avec 2 tronçons
Indice de protection	IP30 / IEC 60529
Normes de sécurité	CEI 60950 / EN 60950
Stabilité aux interférences CEM	EN 50130-4
Emission d'interférences CEM	EN 61000-6-3
Temp. de fonctionnement admissible	-5 °C . . . 50 °C
Température de stockage admissible	-20 °C . . . 60 °C
Humidité relative admissible	max. 95 % sans condensation
Matière du boîtier et couleur	Plastique ABS, (UL94 V-0), satiné anthracite, RAL 7016
Dimensions (H x l x P)	Env. 127 x 96 x 60 mm
Poids	Env. 225 g

Toiminnan kuvaus

Moduulin avulla voidaan asentaa LSN-silmukka, jossa on enintään 254 LSN_{improved} -laitetta tai 127 perinteistä LSN -laitetta ja jonka virrankulutus on enintään 300 mA.

Napojen järjestys

Tunnus	Kuvaus	Liitäntä	
		LSN-silmukka	LSN-johto
1	AUX1 +	Lisäjännitteensyöttö	Lisäjännitteensyöttö, johto 1
2	AUX1 -		
3	LSN a1-	LSN a1-, lähtevä	Johto 1 LSN a1-
4	LSN b1+	LSN b1+, lähtevä	Johto 1 LSN b1+
5	AUX2 +	Lisäjännitteensyöttö***	Lisäjännitteensyöttö, johto 2
6	AUX2 -		
7	LSN a2-	LSN a2-, tuleva	Johto 2 LSN a2-
8	LSN b2+	LSN b2+, tuleva	Johto 2 LSN b2+

*** Lisäjännitteen saa johtaa takaisin AUX2-napaan vain, kun oikosulkuerotin on asennettu silmukkaan (ERT-tekniikka).
[tähän soveltuvat esimerkiksi YBO-R/SCI-oikosulkuerottimet]

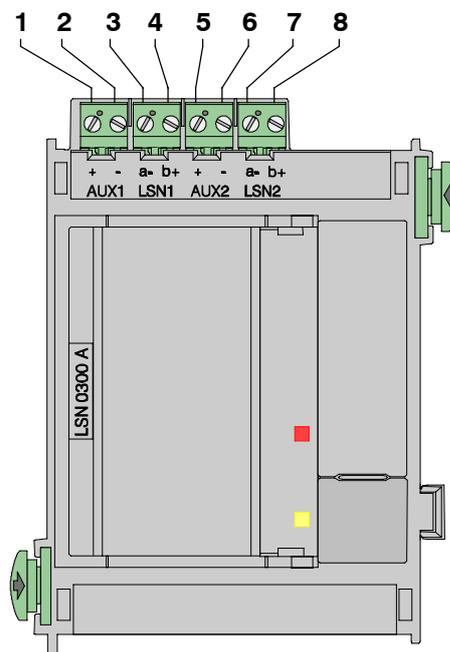

Tekniset tiedot

Ilmais- ja näyttöosat	2 merkkivaloa (1 punainen, hälytys / 1 keltainen, häiriö) 1 painike (merkkivalotesti)
Tulojännite	+20 V DC . . . +30 V DC / +5 V DC ± 5 %
Lähtöjännite:	
- LSN-lepojännite	30 ± 1,0 V DC
- LSN-lähetysjännite	30 ± 1,0 V DC + 1,6 ± 0,15 V DC (jännitealue)
- Lisäsyöttö, AUX	28 ± 1,0 V DC
Enimmäisvirrankulutus	1750 mA (24 VDC)
Nimell. virrankulutus:	
- moduuli	39 mA (24 VDC)
- LSN	1,7 x LSN-laitteiden virrankulutus
- AUX	1,2 x AUX-lisäsyöttö
Kaapelin pituus	enint. 1600 m, kokoonpanon ja kaapelityypin mukaan
LSN-laitteiden määrä	enint. 127 perinteistä LSN-laitetta enint. 254 LSN _{improved} -laitetta
Virrankulutus, LSN	enint. 300 mA, kokoonpanon ja kaapelityypin mukaan,
Lisäsyöttö, AUX (28 V DC)	enint. 500 mA LSN-silmukassa (ERT-tekniikka) tai 2 x enint. 500 mA (2 johtoa)
Suojausluokka	IP 30 / IEC 60529
Turvallisuusstandardit	IEC 60950 / EN 60950
Sähkömagneettinen yhteensopivuus	EN 50130-4
Häiriösäteily (EMC)	EN 61000-6-3
Sallittu käyttölämpötila	-5 °C . . . 50 °C
Sallittu säilytyslämpötila	-20 °C . . . 60 °C
Sallittu suhteellinen kosteus	enint. 95 %, tiivistymätön
Kotelon materiaali ja väri	ABS-muovi (UL94 V-0), puolimatta antrasiitti, RAL 7016
Mitat (K x L x S)	noin 127 x 96 x 60 mm
Paino	noin 225 g

Functional description

This module allows the connection of an LSN loop with up to 254 LSN_{improved} elements or 127 standard LSN elements, with a maximum line current of 300 mA.

Terminal assignment

Pos.	Labelling	Connection	
		LSN loop	LSN stub
1	AUX1 +	Auxiliary power supply	Auxiliary power supply stub 1
2	AUX1 -		
3	LSN a1-	LSN a1- outgoing	Stub 1 LSN a1-
4	LSN b1+	LSN b1+ outgoing	Stub 1 LSN b1+
5	AUX2 +	Auxiliary power supply***	Auxiliary power supply stub 2
6	AUX2 -		
7	LSN a2-	LSN a2- incoming	Stub 2 LSN a2-
8	LSN b2+	LSN b2+ incoming	Stub 2 LSN b2+

*** Auxiliary power must only be returned to AUX2 in looped isolators (ERT systems). [Suitable isolators include YBO-R/SCI isolators]

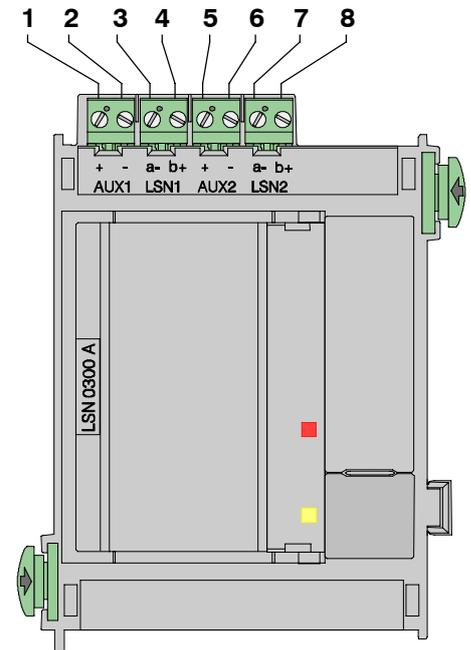

Technical specifications

Operating and display elements	2 LEDs (1x red, alarm/1x yellow, fault) 1 button (LED test)
Input voltage	+20 V DC . . . +30 V DC/+5 V DC ± 5%
Output voltage: - LSN standby voltage - LSN transmission voltage - AUX auxiliary power	30 ± 1,0 V DC 30 ± 1,0 V DC + 1.6 ± 0.15 V DC (voltage hub) 28 ± 1.0 V DC
Maximum current consumption	1750 mA at 24 V DC
Nominal current consumption: - Module - LSN - AUX	39 mA at 24 V DC 1.6 x current consumption of LSN elements 1.35 x AUX auxiliary power
Line length	Max. 1600 m, depending on configuration and cable type
Number of LSN elements	Max. 127 standard LSN elements Max. 254 LSN _{improved} elements
LSN line current	Max. 300 mA, depending on configuration and cable type
AUX auxiliary power (28 V DC)	Max. 500 mA in an LSN loop (ERT system) or 2 x max. 500 mA in 2 stubs
Protection type	IP30/IEC 60529
Safety standards	IEC 60950 / EN 60950
EMC immunity	EN 50130-4
EMC emission	EN 61000-6-3
Permissible operating temperature	-5 °C . . . 50 °C
Permissible storage temperature	-20 °C . . . 60 °C
Relative humidity	Max. 95 % non-condensing
Housing material and colour	ABS plastic, (UL94 V-0), semi-gloss anthracite, RAL 7016
Dimensions (w x h x l)	Approx. 127 x 96 x 60 mm
Weight	Approx. 225 g

Περιγραφή λειτουργίας

Το δομοστοιχείο επιτρέπει τη σύνδεση ενός βρόχου LSN με έως και 254 στοιχεία βελτιωμένου LSN ή 127 στοιχεία κλασικού LSN σε ένα μέγιστο ρεύμα γραμμής 300 mA.

Αντιστοίχιση ακροδεκτών

Θέση	Επιγραφή	Σύνδεση	
		Βρόχος LSN	Ειδικό τεμάχιο διακλάδωσης σωλήνα LSN
1	AUX1 +	Πρόσθετη τροφοδοσία τάσης	Πρόσθετη τροφοδοσία τάσης ειδικού τεμαχίου διακλάδωσης σωλήνα 1
2	AUX1 -		
3	LSN a1-	LSN a1- εξερχόμενο	Ειδικό τεμάχιο διακλάδωσης σωλήνα 1 LSN a1-
4	LSN b1+	LSN b1+ εξερχόμενο	Ειδικό τεμάχιο διακλάδωσης σωλήνα 1 LSN b1+
5	AUX2 +	Πρόσθετη τροφοδοσία τάσης***	Πρόσθετη τροφοδοσία τάσης ειδικού τεμαχίου διακλάδωσης σωλήνα 2
6	AUX2 -		
7	LSN a2-	LSN a2- εισερχόμενο	Ειδικό τεμάχιο διακλάδωσης σωλήνα 2 LSN a2-
8	LSN b2+	LSN b2+ εισερχόμενο	Ειδικό τεμάχιο διακλάδωσης σωλήνα 2 LSN b2+

*** Μόνο στην περίπτωση διατάξεων απομόνωσης που βρίσκονται στο βρόχο (τεχνολογία ERT) επιτρέπεται η επιστροφή της πρόσθετης τάσης στο AUX2! [για παράδειγμα ενδεικνύονται οι διατάξεις απομόνωσης που βρίσκονται στο βρόχο YBO-R/SC1]

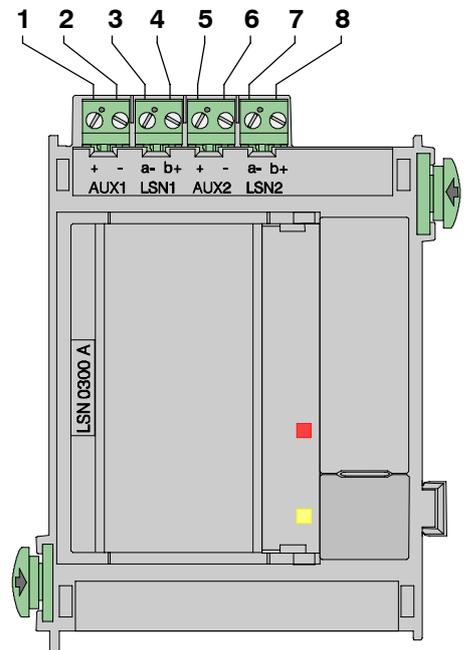

Τεχνικά δεδομένα

Στοιχεία χειρισμού και ενδείξεων	2 λυχνίες LED (1 x κόκκινη, συναγερμός/ 1 x κίτρινη, βλάβη) 1 πλήκτρο (έλεγχος LED)
Τάση εισόδου	+20 V DC . . . +30 V DC / +5 V DC ± 5 %
Τάση εξόδου: - Τάση χωρίς φορτίο LSN - Τάση παροχής LSN - Επιπρόσθετη παροχή AUX	30 ± 1,0 V DC 30 ± 1,0 V DC + 1,6 ± 0,15 V DC (διακύμανση τάσης) 28 ± 1,0 V DC
Μέγιστη κατανάλωση ρεύματος	1750 mA σε 24 V DC
Ονομ. κατανάλωση ρεύματος: - Δομοστοιχείο - LSN - AUX2	39 mA σε 24 V DC 1,7 x κατανάλωση ρεύματος των στοιχείων LSN 1,2 x πρόσθετη τροφοδοσία AUX
Μήκος καλωδίου	μέγ. 1600 m, ανάλογα με τη διαμόρφωση και τον τύπο καλωδίου
Αριθμός στοιχείων LSN	μέγ. 127 στοιχεία κλασικού LSN μέγ. 254 στοιχεία βελτιωμένου LSN
Ρεύμα γραμμής LSN	μέγ. 300 mA, ανεξάρτητα από τη διαμόρφωση και τον τύπο καλωδίου
Επιπρόσθετη παροχή AUX (28 V DC)	μέγ. 500 mA σε βρόχο LSN (τεχνολογία ERT) ή 2 x μέγ. 500 mA σε περίπτωση 2 ειδικά τεμάχια διακλάδωσης σωλήνα
Κλάση προστασίας	IP30 / IEC 60529
Πρότυπα ασφαλείας	IEC 60950 / EN 60950
Ηλεκτρομαγνητική συμβατότητα-Ατρωσία	EN 50130-4
Εκπομπή παρεμβολών ΗΜΣ	EN 61000-6-3
Επιτρεπόμενη θερμοκρασία λειτουργίας	-5 °C . . . 50 °C
Επιτρεπόμενη θερμοκρασία αποθήκευσης	-20 °C . . . 60 °C
Επιτρεπόμενη σχετική υγρασία	μέγ. 95 %, χωρίς συμπύκνωση
Υλικό περιβλήματος και χρώμα	Πλαστικό ABS, (UL94 V-0), σατινέ ανθρακί, RAL 7016
Διαστάσεις (Υ x Π x Β)	περίπου 127 x 96 x 60mm
Βάρος	περίπου 225 g

Működési leírás

A modul egy max. 254 LSN_{improved} - elemmel vagy 127 klasszikus LSN - elemmel rendelkezik LSN-hurok illesztését teszi lehetővé max. 300 mA vonali áram mellett.

Kapocskiosztás

Poz.	Felirat	Csatlakozás	
		LSN-hurok	LSN-ág
1	AUX1 +	Kiegészít feszültségellátás	Kiegészít feszültségellátás 1. ág
2	AUX1 -		
3	LSN a1-	LSN a1- kimen	1. ág LSN a1-
4	LSN b1+	LSN b1+ kimen	1. ág LSN b1+
5	AUX2 +	Kiegészít feszültségellátás***	Kiegészít feszültségellátás 2. ág
6	AUX2 -		
7	LSN a2-	LSN a2- bemen	2. ág LSN a2-
8	LSN b2+	LSN b2+ bemen	2. ág LSN b2+

*** Csak akkor szabad a kiegészít feszültséget az AUX2 kimenetbe visszavezetni ha a tápfeszültség-hurokba rövidzár-szakaszoló (ERT-technológia) vannak beépítve. [erre például az YBO-R/SCI leválasztóelem alkalmas]! [erre például az YBO-R/SCI-választóelem alkalmas]

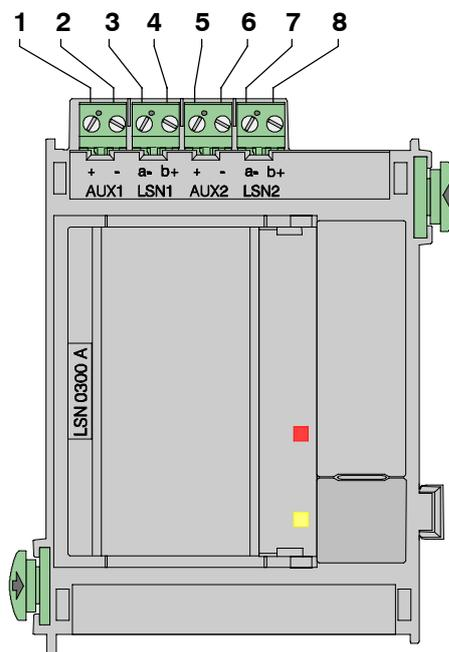

Műszaki adatok

Kezel- és kijelz elemek	2 LED (1 piros, riasztás/ 1 sárga, hiba) 1 gomb (LED-teszt)
Bemen feszültség	+20 V DC . . . +30 V DC / +5 V DC ± 5 %
Kimenetfeszültség: - LSN nyugalmi feszültség - LSN adófeszültség - AUX kiegészít tápfeszültség	30 ± 1,0 V DC 30 ± 1,0 V DC + 1,6 ± 0,15 V DC (feszültséglököt) 28 ± 1,0 V DC
Maximális áramfelvétel	1750 mA 24 V DC mellett
Névleges: - modul áramfelvétel - LSN - AUX	39 mA 24 V DC mellett Az LSN-elem áramfelvételének 1,7-szerese Az AUX kiegészít tápfeszültségének 1,2-szerese
Vezetékhoossz	max. 1600 m, a konfigurációtól és a vezeték típusától függ
LSN-elemek száma	max. 127 klasszikus LSN-elem max. 254 LSN _{improved} elem
Az LSN vonali árama	max. 300 mA, a konfigurációtól és a vezeték típusától függ,
Az AUX kiegészít tápfeszültsége (28 V DC)	max. 500 mA egy LSN-hurok esetén (ERT-technika) ill. 2 x max. 500 mA 2 ág esetén
Érintésvédelem	IP30 / IEC 60529
Biztonsági szabványok	IEC 60950 / EN 60950
EMV-zavarállóság	EN 50130-4
EMV-zavarkibocsátás	EN 61000-6-3
Megengedett üzemi hőmérséklet	-5 °C . . . 50 °C .
Megengedett tárolási hőmérséklet	-20 °C . . . 60 °C .
Megengedett relatív páratartalom	max. 95 %, nem kondenzáló
A ház anyaga és színe	ABS anyag, (UL94 V-0), selymesen matt fény antracit, RAL 7016
Méret (ma. x szé. x mé.)	kb. 127 x 96 x 60mm
Tömeg	kb. 225 g

Opis funkcija

Modul omogućuje spajanje LSN petlje sa do 254 LSN_{poboljšanih} - elemenata ili 127 klasinih LSN - elemenata pri maksimalnoj struji petlje od 300 mA.

Raspored stezaljki

Pol.	Opis	Priključak	
		LSN-petlja	LSN-priključak
1	AUX1 +	Napajanje dodatnim naponom	Napajanje dodatnim naponom priključak 1
2	AUX1 -		
3	LSN a1-	LSN a1- izlazni	Priključak 1 LSN a1-
4	LSN b1+	LSN b1+ izlazni	Priključak 1 LSN b1+
5	AUX2 +	Napajanje dodatnim naponom***	Napajanje dodatnim naponom priključak 2
6	AUX2 -		
7	LSN a2-	LSN a2- ulazni	Priključak 2 LSN a2-
8	LSN b2+	LSN b2+ ulazni	Priključak 2 LSN b2+

*** Pomono napajanje mora biti proslijeeeno na AUX 2 jedino kod ugraenih izolatora petlje (ERT-sistemi) U odgovarajue izolatore petlje ukljueni su i [YBO-R/SCI-izolatori !]

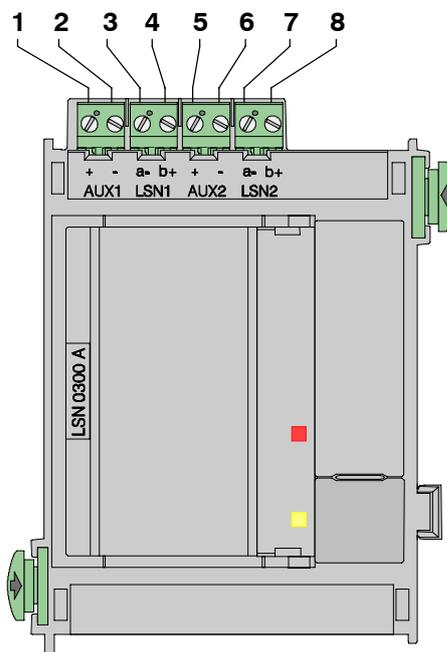

Tehnike specifikacije

Elementi za prikazivanje i rukovanje	2 LED svjetlee diode (1 x crvena, alarm/ 1 x žuta, smetnja) 1 tipka (LED-test)
Ulazni napon	+20 V DC (istosmjerne struje). . . +30 V DC / +5 V DC ± 5 %
Izlazni napon: - LSN-napon mirovanja - LSN-odašiljaki napon - Dodatno napajanje AUX	30 ± 1,0 V DC 30 ± 1,0 V DC + 1,6 ± 0,15 V DC 28 ± 1,0 V DC
Maksimalna potrošnja struje	1750 mA pri 24 V DC
Naz. potrošnja struje: - modula - LSN-a - AUX-a	39 mA pri 24 V DC 1,7 x potrošnja struje LSN-elemenata 1,2 x dodatno napajanje AUX
Duljina kabela	maks. 1600 m, ovisno o konfiguraciji i vrsti kabela
Broj LSN elemenata	maks. 127 klasinih LSN elemenata maks. 254 LSN _{poboljšanih} elemenata
Struja petlje LSN	maks. 300 mA, ovisno o konfiguraciji i vrsti kabela
Dodatno napajanje AUX (28 V DC)	maks. 500 mA kod jedne LSN-petlje (ERT-tehnologija) tj. 2 x maks. 500 mA kod 2 prikljuka
Vrsta zaštite	IP30 / IEC 60529
Sigurnosni standardi	IEC 60950 / EN 60950
EMV-otpornost na smetnje	EN 50130-4
EMV-emitiranje smetnji	EN 61000-6-3
Dopuštena radna temperatura	-5 °C . . . 50 °C
Dopuštena temp. skladištenja	-20 °C . . . 60 °C
Dopuštena relativna vlažnost	maks. 95 % bez kondenzacije
Materijal i boja kuišta	ABS plastika, (UL94 V-0), polusjajni antracit, RAL 7016
Dimenzije (V x Š x D)	oko. 127 x 96 x 60 mm
Težina	oko 225 g

Descrizione del funzionamento

Il modulo permette la connessione di una linea LSN con un massimo di 254 elementi LSN_{improved} o 127 elementi LSN standard con una corrente di linea massima di 300 mA.

Assegnazione dei morsetti

Pos.	Dicitura	Connessione	
		Linea LSN	Diramazione LSN
1	AUX1 +	Alimentazione di tensione supplementare	Alimentazione di tensione supplementare diramazione 1
2	AUX1 -		
3	LSN a1-	LSN a1- in uscita	Diramazione 1 LSN a1-
4	LSN b1+	LSN b1+ in uscita	Diramazione 1 LSN b1+
5	AUX2 +	Alimentazione di tensione supplementare***	Alimentazione di tensione supplementare diramazione 2
6	AUX2 -		
7	LSN a2-	LSN a2- in entrata	Diramazione 2 LSN a2-
8	LSN b2+	LSN b2+ in entrata	Diramazione 2 LSN b2+

*** La tensione supplementare per AUX2 può essere applicata solo in presenza di elementi di divisione presenti nella linea (tecnica ERT). [ad es. sono adatti elementi di divisione YBO-R/SCI]

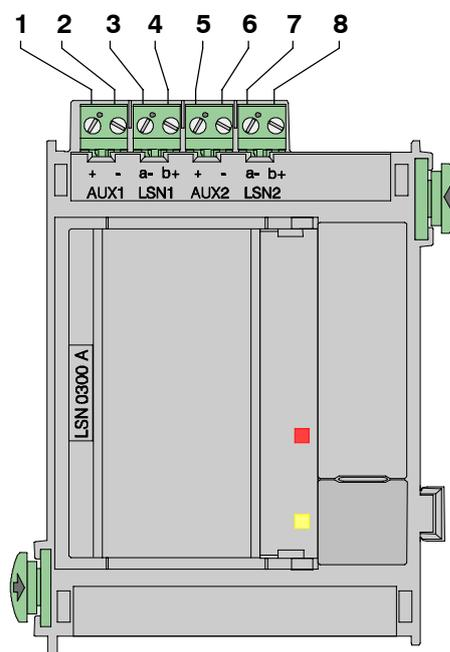

Dati tecnici

Tasti e LED	2 LED (1x rosso, allarme / 1x giallo, anomalia) 1 tasto (verifica LED)
Tensione d'ingresso	+20 V DC . . . +30 V DC / +5 V DC ± 5 %
Tensione in uscita: - LSN-Tensione di riposo - LSN-Tensione di trasmissione - Alimentazione supplementare AUX	30 ± 1,0 V DC 30 ± 1,0 V DC + 1,6 ± 0,15 V DC (aumento tensione) 28 ± 1,0 V DC
Consumo di corrente massimo	1750 mA a 24 V DC
Nom. Consumo di corrente: - modulo - LSN - AUX	39 mA a 24 V DC 1,7 x consumo di corrente degli elementi LSN 1,2 x alimentazione ausiliaria AUX
Lunghezza cavo	max. 1600 m, a seconda della configurazione e del tipo di cavo
Numero di elementi LSN	max. 127 elementi LSN standard max. 254 elementi LSN _{improved}
Corrente linea LSN	max. 300 mA, a seconda della configurazione e del tipo di cavo
Alimentazione ausiliaria AUX (28 V DC)	max. 500 mA per una linea LSN (tecnica ERT) oppure 2 x max. 500 mA per 2 diramazioni
Tipo di protezione	IP30 / IEC 60529
Standard di sicurezza	IEC 60950 / EN 60950
Immunità elettromagnetica	EN 50130-4
Emissione di interferenze elettromagnet.	EN 61000-6-3
Temperatura operativa ammessa	-5 °C . . . 50 °C
Temperatura di stoccaggio ammessa	-20 °C . . . 60 °C
Umidità relativa consentita	max. 95 % senza formazione di condensa
Materiale dell'alloggiamento e colore	Plastica ABS (UL94 V-0), antracite satinata, RAL 7016
Dimensioni (h x l x p)	circa 127 x 96 x 60 mm
Peso	circa 2250 g

Funkcijų aprašymas

Prie modulio galima prijungti LSN žiedą su iki 254 LSN_{pagerintais} elementais arba su 127 klasikiniiais LSN elementais, kai maksimali linijinė srovė yra 300 mA.

Gnybtų išdėstymas

Pad.	Užrašas	Jungtis	
		LSN žiedas	LSN žingsnis
1	AUX1 +	Papildoma maitinimo įtampa	Papildoma maitinimo įtampa, 1 žingsnis
2	AUX1 -		
3	LSN a1-	LSN a1- einanti	1 žingsnis LSN a1-
4	LSN b1+	LSN b1+ einanti	1 žingsnis LSN b1+
5	AUX2 +	Papildoma maitinimo įtampa***	Papildoma maitinimo įtampa, 2 žingsnis
6	AUX2 -		
7	LSN a2-	LSN a2- ateinanti	2 žingsnis LSN a2-
8	LSN b2+	LSN b2+ ateinanti	2 žingsnis LSN b2+

*** Tik esant žiede įmontuotiems skyrimo elementams (ERT technika) papildomą įtampą galima grąžinti į AUX2! [tinkami yra, pvz., YBO-R/SCI skyrimo elementai]

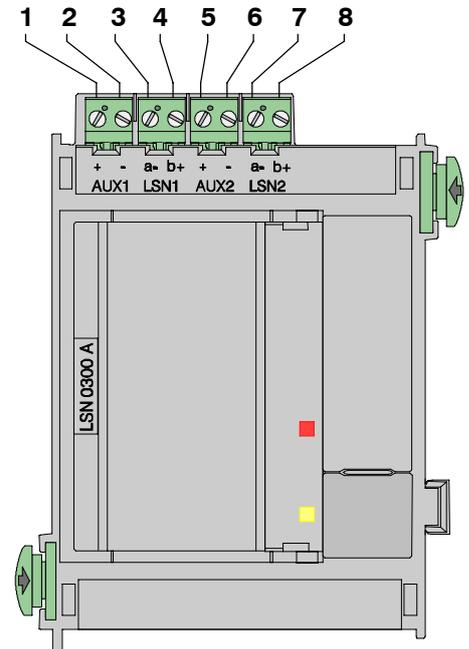

Techniniai duomenys

Valdymo ir rodmenų elementai	2 šviesiniai indikatoriai (1 x raudonas, pavojus/ 1 x geltonas, triktis) 1 mygtukas (šviesinio indikatoriaus patikrinimas)
Įeinanti įtampa	+20 V DC . . . +30 V DC / +5 V DC ± 5 %
Išėjimo įtampa: - LSN įtampa nesiunčiant signalo - LSN įtampa siunčiant signalą - papildomas maitinimas AUX	30 ± 1,0 V DC 30 ± 1,0 V DC + 1,6 ± 0,15 V DC (įtampos šuolis) 28 ± 1,0 V DC
Maksimalus srovės suvartojimas	1750 mA esant 24 V DC
Nom. srovės suvartojimas: - modulis - LSN - AUX	39 mA esant 24 V DC 1,7 x LSN elementų srovės suvartojimas 1,2 x papildomas maitinimas AUX
Kabelio ilgis	maks. 1600 m, atsižvelgiant į konfigūraciją ir kabelio tipą
LSN elementų kiekis	maks. 127 klasikiniai LSN elementai maks. 254 LSN _{pagerinti} elementai
Linijos srovė LSN	maks. 300 mA, atsižvelgiant į konfigūraciją ir kabelio tipą,
Papildomas maitinimas AUX (28 V DC)	maks. 500 mA esant LSN žiedui (ERT technika) ir 2 x maks. 500 mA, kai yra 2 žingsniai
Apsaugos klasė	IP30 / IEC 60529
Saugos standartai	IEC 60950 / EN 60950
EMV atsparumas triktims	EN 50130-4
EMV trikčių išsiuntimas	EN 61000-6-3
Leistina darbinė temperatūra	-5 °C . . . 50 °C
Leistina sandėliavimo temp.	-20 °C . . . 60 °C
Leistina santykinė drėgmė	maks. 95%, nesikondensuojanti
Korpuso medžiaga ir spalva	ABS plastmasė, (UL94 V-0), matinis antracitas, RAL 7016
Matmenys (A x P x G)	apytiksliai 127 x 96 x 60 mm
Svoris	apytiksliai 225 g

Funkciju apraksts

Modulis ļauj pievienot LSN gredzenu ar līdz pat 254 LSN_{improved} - elementiem vai 127 klasiskajiem LSN - elementiem ar maksimālo elektrolīnijas strāvu 300 mA.

Spaiļu izvietojums

Poz.	Marķējums	Pieslēgums	
		LSN gredzens	LSN pieslēgums
1	AUX1 +	Papildu strāvas apgāde	Papildu strāvas apgāde, pieslēgums 1
2	AUX1 -		
3	LSN a1-	LSN a1- uz	Pieslēgums 1 LSN a1-
4	LSN b1+	LSN b1+ uz	Pieslēgums 1 LSN b1+
5	AUX2 +	Papildu strāvas apgāde***	Papildu strāvas apgāde, pieslēgums 2
6	AUX2 -		
7	LSN a2-	LSN a2- no	Pieslēgums 2 LSN a2-
8	LSN b2+	LSN b2+ no	Pieslēgums 2 LSN b2+

*** Tikai pie gredzenā ievietotiem atdalītājelementiem (ERT-paņēmiens) drīkst pievadīt papildu strāvu pie AUX2! [piemēroti ir, piem., YBO-R/SCI-atsdalītājelementi]

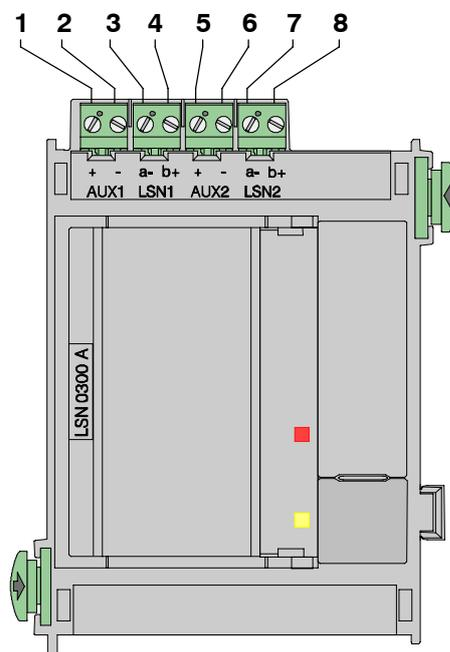

Tehniskie dati

Apkalpes un indikācijas elementi	2 gaismas diodes (1 x sarkana, trauksme/ 1 x dzeltena, traucējums), 1 taustiņš (gaismas diode - tests)
Ieejas spriegums	+20 V DC . . . +30 V DC / +5 V DC ± 5 %
Izejas spriegums: - LSN-darba spriegums - LSN-raidītājspriegums - papildu apgāde AUX	30 ± 1,0 V DC 30 ± 1,0 V DC + 1,6 ± 0,15 V DC (sprieguma trieciens) 28 ± 1,0 V DC
Maksimālais strāvas patēriņš	41750 mA pie 24 V DC
Nom. Strāvas patēriņš: - modulis - LSN - AUX	39 mA pie 24 V DC 1,7 x LSN-elementu strāvas patēriņš 1,2 x papildu apgāde AUX
Elektrolīnijas garums	maks. 1600 m, atkarībā no konfigurācijas un kabeļa veida
LSN elementu skaits	maks. 127 klasiskie LSN elementi maks. 254 LSN _{uzlabotie} elementi
Elektrolīnijas strāva LSN	maks. 300 mA, atkarībā no konfigurācijas un kabeļa veida,
Papildu apgāde AUX (28 V DC)	maks. 500 mA vienam LSN gredzenam (ERT paņēmiens) resp., 2 x maks. 500 mA 2 pieslēgumiem
Aizsardzības veids	IP30 / IEC 60529
Drošības standarti	IEC 60950 / EN 60950
EMV elektromagnētiskā savietojamība	EN 50130-4
EMV elektromagnētiskie traucējumi	EN 61000-6-3
Pieļaujamā ekspluatācijas temperatūra	-5 °C . . . 50 °C .
Pieļaujamā uzglabāšanas temperatūra	-20 °C . . . 60 °C .
Pieļaujamais relatīvais mitrums	maks. 95 %, bez kondensāta
Korpusa materiāls un krāsa	ABS plastmasa, (UL94 V-0), zīdīgi matēts antracīts, RAL 7016
Izmēri (A x P x B)	aptuv. 127 x 96 x 60mm
Svars	aptuv. 225 g

Funksjonsbeskrivelse

Modulen gjør det mulig å koble til en LSN-ring med inntil 254 LSN_{improved} - elementer eller 127 klassiske LSN - elementer ved en maksimal linjestrøm på 300 mA.

Klemmeplassering

Pos.	Skrift	Tilkobling	
		LSN-ring	LSN-blindledning
1	AUX1 +	Ekstra spenningsforsyning	Ekstra spenningsforsyning, blindledning 1
2	AUX1 -		
3	LSN a1-	LSN a1-utgående	Blindledning 1 LSN a1-
4	LSN b1+	LSN b1+utgående	Blindledning 1 LSN b1+
5	AUX2 +	Ekstra spenningsforsyning***	Ekstra spenningsforsyning, blindledning 2
6	AUX2 -		
7	LSN a2-	LSN a2-inngående	Blindledning 2 LSN a2-
8	LSN b2+	LSN b2+inngående	Blindledning 2 LSN b2+

*** Den ekstra spenningstilførselen skal bare føres tilbake til AUX2 hvis det er satt inn skilleelementer (ERT-teknikk) i ringen.
[Du kan f.eks. bruke YBO-R/SCI-skilleelementer]

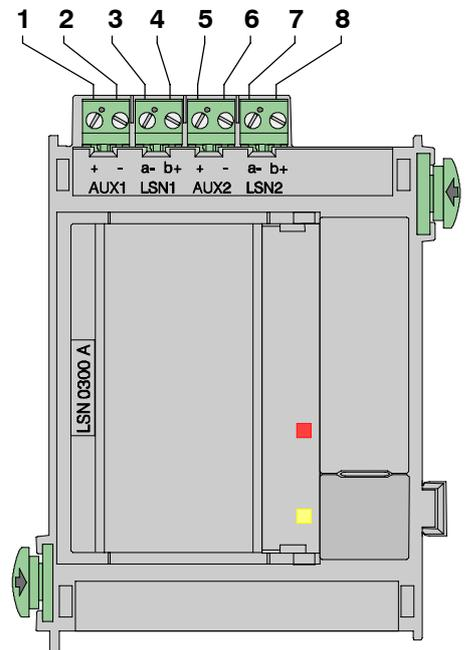

Tekniske data

Betjenings- og visningselementer	2 LED-lamper (1 x rød for alarm, 1 x gul for feil) 1 knapp (LED-test)
Inngangsspenning	+20 V DC . . . +30 V DC / +5 V DC ± 5 %
Utgangsspenning	
- LSN-hvilespenning	30 ± 1,0 V DC
- LSN-senderspenning	30 ± 1,0 V DC + 1,6 ± 0,15 V DC (spenningsøkning)
- Tilleggsforsyning AUX	28 ± 1,0 V DC
Maksimalt strømpoptak	1750 mA ved 24 V DC
Nom. strømpoptak:	
- Modul	39 mA ved 24 V DC
- LSN	1,7 x strømpoptak for LSN-elementene
- AUX	1,2 x tilleggsforsyning AUX
Ledningslengde	Maks. 1600 m, avhengig av konfigurasjonen og ledningstypen
Antall LSN-elementer	Maks. 127 klassiske LSN-elementer Maks. 254 LSN _{improved} elementer
Linjestrøm LSN	Maks. 300 mA avhengig av konfigurasjonen og ledningstypen
Tilleggsforsyning AUX (28 V DC)	Maks. 500 mA ved en LSN-ring (ERT-teknikk) eller 2 x maks. 500 mA ved 2 blindledninger
Verneklasse	IP30 / IEC 60529
Sikkerhetsstandarder	IEC 60950 / EN 60950
EMC, immunitet	EN 50130-4
EMC, stråling	EN 61000-6-3
Tillatt driftstemperatur	-5 °C . . . 50 °C
Tillatt lagringstemperatur	-20 °C . . . 60 °C
Tillatt relativ fuktighet	maks. 95 % ikke-kondenserende
Husmateriale og -farge	ABS-plast (UL94 V-0), silkematt antrasitt, RAL 7016
Mål (H x B x D)	ca. 127 x 96 x 60 mm
Vekt	ca. 225 g

Basisfuncties

De module maakt de aansluiting van een LSN-lus met maximaal 254 LSN_{improved} - elementen of 127 klassieke LSN - elementen mogelijk, bij een maximale lijnstroom van 300 mA.

Klembezetting

Pos.	Label	Aansluiting	
		LSN-lus	LSN-steeklijn
1	AUX1 +	Extra voeding	Extra voeding steeklijn 1
2	AUX1 -		
3	LSN a1-	LSN a1- uitgaand	Steeklijn 1 LSN a1-
4	LSN b1+	LSN b1+ uitgaand	Steeklijn 1 LSN b1+
5	AUX2 +	Extra voeding***	Extra voeding steeklijn 2
6	AUX2 -		
7	LSN a2-	LSN a2- ingaand	Steeklijn 2 LSN a2-
8	LSN b2+	LSN b2+ ingaand	Steeklijn 2 LSN b2+

*** Alleen bij in de ringleiding toegepaste scheidings-elementen (ERT-technologie) mag de extra voeding worden teruggevoerd naar AUX2! [geschikte scheidings-elementen zijn bijv. YBO-R/SCI-elementen]

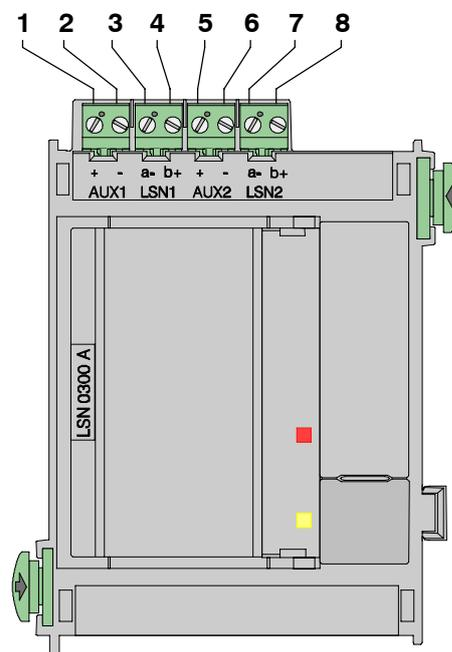

Technische specificaties

Bedieningselementen en indicatoren	2 LED's (1 x rood, alarm / 1 x geel, storing) 1 toets (LED-test)
Ingangsspanning	+20 V DC . . . +30 V DC / +5 V DC ± 5 %
Uitgangsspanning:	
- stand-by-spanning LSN	30 ± 1,0 V DC
- spanning LSN	30 ± 1,0 V DC + 1,6 ± 0,15 V DC (spanningsfluctuatie)
- extra voeding AUX	28 ± 1,0 V DC
Maximaal stroomverbruik	1750 mA bij 24 V DC
Nom. stroomverbruik:	
- module	39 mA bij 24 V DC
- LSN	1,7 x stroomverbruik van de LSN-elementen
- AUX	1,2 x extra voeding AUX
Kabellengte	max. 1600 m, afhankelijk van configuratie en kabeltype
Aantal LSN-elementen	max. 127 conventionele LSN-elementen max. 254 LSN _{improved} -elementen
Lijnstroom LSN	max. 300 mA, afhankelijk van configuratie en kabeltype,
Extra voeding AUX (28 V DC)	max. 500 mA als lus (ERT-techniek) of 2 x max. 500 mA bij 2 steeklijnen
Beschermingsklasse	IP30 / IEC 60529
Veiligheidsnormen	IEC 60950 / EN 60950
EMC-storingsbestendigheid	EN 50130-4
EMC-emissie	EN 61000-6-3
Toegestane bedrijfstemperatuur	-5 °C . . . 50 °C
Toegestane opslagtemperatuur	-20 °C . . . 60 °C
Toegestane relatieve vochtigheid	max. 95% niet-condenserend
Materiaal en kleur van de behuizing	ABS-kunststof, (UL94 V-0), zijdemat antraciet, RAL 7016
Afmetingen (h x b x d)	ca. 127 x 96 x 60 mm
Gewicht	ca. 225 g

Funções

O módulo permite ligar um ou dois loops LSN com um máximo de 254 elementos LSN_{improved} ou 127 elementos LSN clássicos, com uma corrente de linha máxima de 300 mA.

Ligações eléctricas

Pos.	Legenda-gem	Ligação	
		Loop LSN	Ramal LSN
1	AUX1 +	Fonte de alimentação auxiliar	Fonte de alimentação auxiliar ramal 1
2	AUX1 -		
3	LSN a1-	LSN a1- (saída)	Ramal 1 LSN a1-
4	LSN b1+	LSN b1+ (saída)	Ramal 1 LSN b1+
5	AUX2 +	Fonte de alimentação auxiliar***	Fonte de alimentação auxiliar ramal 2
6	AUX2 -		
7	LSN a2-	LSN a2- (entrada)	Ramal 2 LSN a2-
8	LSN b2+	LSN b2+ (entrada)	Ramal 2 LSN b2+

*** A alimentação auxiliar AUX2 só deve ser usada quando existirem isoladores instalados num loop (tecnologia ERT)! [neste caso estão, p. ex., os isoladores YBO-R/SCI]

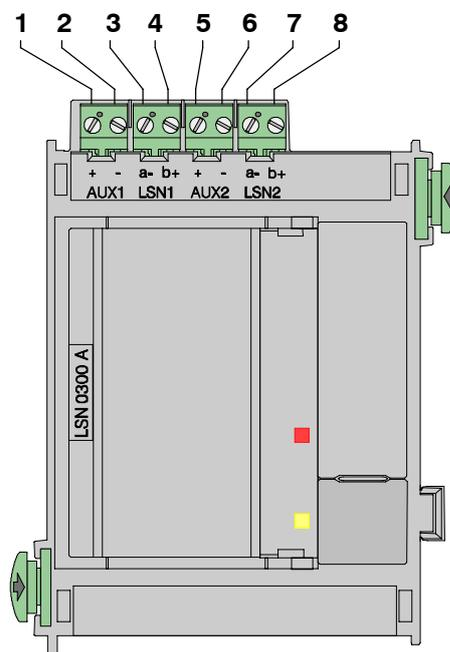

Dados técnicos

Elementos de operação e indicação	2 LEDs (1 x vermelho, alarme/1 x amarelo, falha) 1 tecla (teste LED)
Tensão de entrada	+20 Vdc . . . +30 Vdc / +5 Vdc ± 5 %
Tensão de saída: - Tensão em repouso LSN - Tensão de transmissão LSN - Fonte de alimentação auxiliar AUX	30 ± 1,0 Vdc 30 ± 1,0 Vdc + 1,6 ± 0,15 Vdc (curso da tensão) 28 ± 1,0 Vdc
Consumo de corrente máx.	1750 mA a 24 Vdc
Consumo de corrente nominal: - Módulo - LSN - AUX	39 mA a 24 Vdc 1,7 x consumo de corrente dos elementos LSN 1,2 x fonte de alimentação auxiliar AUX
Comprimento de cabo	máx. 1600 m, consoante a configuração e o tipo de cabo
Quantidade de elementos LSN	máx. 127 elementos LSN clássicos máx. 254 elementos LSN _i
Corrente de linha LSN	máx. 300 mA, consoante a configuração e o tipo de cabo,
Fonte de alimentação auxiliar AUX (28 V dc)	máx. 500 mA com um loop LSN (tecnologia ERT) ou 2 x máx. 500 mA com 2 ramos
Índice de protecção	IP 30 / CEI 60529
Normas de segurança	CEI 60950/EN 60950
Resistência a interferências CEM	EN 50130-4
Emissão de interferências CEM	EN 61000-6-3
Temperatura de funcionamento permitida	-5 °C . . . 50 °C
Temp. de armazenamento permitida	-20 °C . . . 60 °C
Humidade relativa permitida	máx. 95 % sem condensação
Material da caixa e cor	Plástico ABS (UL94 V-0), antracite acetinado, RAL 7016
Dimensões (A x L x P)	aprox. 127 x 96 x 60 mm
Peso	aprox. 225 g

Opis funkcjonalny

Moduł umożliwia podłączenie pętli LSN z 254 elementami pracującymi w udoskonalonej technologii LSN (LSN_{improved}) lub 127 elementami pracującymi w klasycznej technologii LSN, przy maksymalnym natężeniu prądu linii rzędu 300 mA.

Funkcje zacisków

Poz.	Opis	Złącze	
		Pętla LSN	Odgańlenie LSN
1	AUX1 +	Dodatkowe zasilanie napięciem	Dodatkowe zasilanie napięciem – odgańlenie 1
2	AUX1 -		
3	LSN a1-	Wyjście LSN a1-	Odgańlenie 1 LSN a1-
4	LSN b1+	Wyjście LSN b1+	Odgańlenie 1 LSN b1+
5	AUX2 +	Dodatkowe zasilanie napięciem***	Dodatkowe zasilanie napięciem – odgańlenie 2
6	AUX2 -		
7	LSN a2-	Wejście LSN a2-	Odgańlenie 2 LSN a2-
8	LSN b2+	Wejście LSN b2+	Odgańlenie 2 LSN b2+

*** Dodatkowe zasilanie napięciem może być doprowadzane do wyjścia AUX2 tylko w przypadku instalacji w pętli izolatorów (technika ERT)! [odpowiednie są np. izolatory YBO-R/SCI]

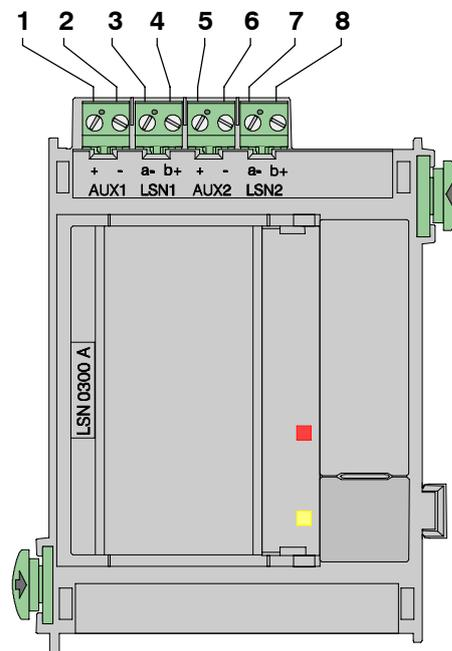

Dane techniczne

Elementy obsługowe i wskaźniki	2 diody LED (1x czerwona – alarm / 1x żółta – usterka) 1 przycisk (test diod LED)
Napięcie na wejściu	+20 V DC . . +30 V DC / +5 V DC ± 5 %
Napięcie wyjściowe: - napięcie czuwania LSN - napięcie alarmu LSN - zasilanie dodatkowe AUX	30 ± 1,0 V DC 30 ± 1,0 V DC + 1,6 ± 0,15 V DC (skok napięcia) 28 ± 1,0 V DC
Maksymalny pobór prądu	1750 mA przy 24 V DC
Nom. pobór prądu: - moduł - LSN - AUX	39 mA przy 24 V DC 1,7 x pobór prądu elementów pętli LSN 1,2 x dodatkowe zasilanie napięciem AUX
Długość przyłączonej pętli dozorowej	maks. 1600 m, zależnie od konfiguracji i typu kabla
Liczba elementów pętli LSN	maks. 127 elementów pracujących w klasycznej technologii LSN maks. 254 elementy pracujące w udoskonalonej technologii LSN _{improved}
Prąd linii LSN	maks. 300 mA, zależnie od konfiguracji i typu kabla,
Dodatkowe zasilanie napięciem AUX (28 V DC)	maks. 500 mA w pętli LSN (technika ERT) lub 2 x maks. 500 mA przy 2 odgańleniach
Klasa ochrony	IP30 / IEC 60529
Standard bezpieczeństwa	IEC 60950 / EN 60950
Odporność na zakłócenia elektromagn.	EN 50130-4
Wytwarzanie zakłóceń elektromagn.	EN 61000-6-3
Dopuszczalna temp. pracy	-5 °C . . . 50 °C
Dopuszczalna temp. przechowywania	-20 °C . . . 60 °C
Dopuszczalna wilgotność względna	maks. 95 %, bez kondensacji
Materiał i kolor obudowy	tworzywo ABS, (UL94 V-0), antracyt, półmat, RAL 7016
Wymiary (wys. x szer. x gł.)	ok. 127 x 96 x 60 mm
Masa	ok. 225 g

Descrierea Funcional

Modulul permite conectarea unei bucle LSN cu pân la 254 elemente LSN_{improved} sau 127 elemente LSN clasice la un curent de linie de 300 mA.

Semnificaie terminale

Poz.	Etichet	Conexiune	
		Bucl LSN	Ramur LSN
1	AUX1 +	Alimentare cu tensiune auxiliar	Alimentare cu tensiune auxiliar ramur 1
2	AUX1 -		
3	LSN a1-	LSN a1- de ieire	Ramur 1 LSN a1-
4	LSN b1+	LSN b1+ de ieire	Ramur 1 LSN b1+
5	AUX2 +	Surs de alimentare suplimentar***	Alimentare cu tensiune auxiliar ramur 2
6	AUX2 -		
7	LSN a2-	LSN a2- de intrare	Ramur 2 LSN a2-
8	LSN b2+	LSN b2+ de intrare	Ramur 2 LSN b2+

*** Tensiunea de alimentare auxiliar trebuie rotat doar ctre intrarea AUX2 a modulelor izolatoare montate în bucl (sisteme ERT).
[module izolatoare adecvate, ex. YBO-R/SCI]

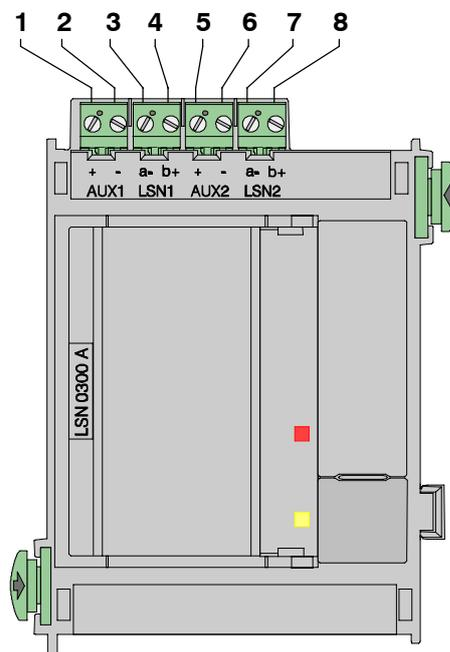

Date tehnice

Elemente de operare si afiare	2 LED-uri (1 x rou, alarm/1 x galben, defeciuene) 1 tast (testare LED-uri)
Tensiune de intrare	+20 V CC. . . +30 V CC/+5 V CC ± 5 %
Tensiune de ieire: - Valoare de stand-by pe bucla LSN - Valoarea semnalului pe bucla LSN - Valoare tensiune auxiliar	30 ± 1,0 V CC 30 ± 1,0 V CC + 1,6 ± 0,15 V CC (Curs de tensiune) 28 ± 1,0 V CC
Consum de curent maxim	1750 mA la 24 V CC
Consum nominal: - Modul - LSN - AUX	239 mA la 24 V CC 1,7 x consumul elementelor LSN 1,2 x AUX tensiunea de alimentare auxiliar
Lungimea liniei de bucl	3000 m maxim, depinzând de configuraie si tipul de cablu folosit
Numrul de elemente LSN	Maxim 127 elemente LSN Standard Maxim 254 elemente LSN _{improved}
Curentul pe bucla LSN	Maxim 300 mA, depinzând de configuraie si tipul de cablu folosit
AUX Tensiunea de alimentare auxiliar (28 V CC)	Maxim 500 mA într-o bucla LSN (sistem ERT) sau 2 x max 500mA in doua ramuri
Stadard de protectie	IP30 / IEC 60529
Standarde de siguran	IEC 60950 / EN 60950
Imunitate la zgomot CEM	EN 50130-4
Emisie CEM	EN 61000-6-3
Temperatur de operare admis	-5 °C . . . 50 °C
Temperatura de depozitare admis	-20 °C . . . 60 °C
Umiditate relativ admis	max. 95% fr condens
Material carcas i culoare	ABS Material sintetic, (UL94 V-0), mat. mtsos antracit, RAL 7016
Dimensiuni (lime, lungime, grosime)	Cca. 127 x 96 x 60 mm
Greutate	Cca. 225 g

Описание основных функций

Модуль позволяет подключать кольцевой шлейф LSN с числом элементов LSN_{improved} до 254 или 127 классических LSN - элементов при максимальном линейном токе 300 мА.

Распределение клемм

Поз.	Маркировка	Подсоединение	
		Кольцевой шлейф LSN	Радиальный шлейф LSN
1	AUX1 +	Источник дополнительного питания	Источник дополнительного питания для шлейфа 1
2	AUX1 -		
3	LSN a1-	LSN a1- выход	Шлейф 1 LSN a1-
4	LSN b1+	LSN b1+ выход	Шлейф 1 LSN b1+
5	AUX2 +	Источник дополнительного питания***	Источник дополнительного питания для шлейфа 2
6	AUX2 -		
7	LSN a2-	LSN a2- вход	Шлейф 2 LSN a2-
8	LSN b2+	LSN b2+ вход	Шлейф 2 LSN b2+

*** Подключать добавочное напряжение на AUX2 можно только при установке изоляторов (ERT-Technik) в кольцевом шлейфе! [Подходят, например, элементы YBO-R/SCI]

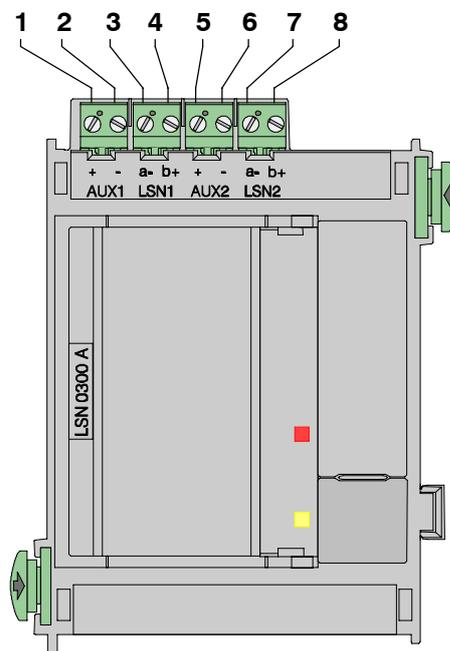

Технические характеристики

Элементы управления и индикации	2 светодиодных индикатора (1 красный, сигнал тревоги / 1 желтый, неполадки), 1 кнопка (тест светодиодов)
Входное напряжение	+20 В постоянного тока. . . +30 В постоянного тока / +5 В постоянного тока ± 5 %
Выходное напряжение: - напряжение покоя LSN - передающее напряжение LSN - Дополнительное питание AUX	30 ± 1,0 В пост. тока 30 ± 1,0 В пост. тока + 1,6 ± 0,15 В пост. тока (диапазон измерения напряжения) 28 ± 1,0 В пост. тока
Максимальное потребление тока	1750 мА при 24 В пост. тока
Номинальное потребление тока: - Модуль - LSN - AUX	39 мА при 24 В пост. тока 1,7 x потребление тока элементов LSN 1,2 x дополнительное питание AUX
Длина линии	макс. 1600 м, в зависимости от конфигурации и типа кабеля
Число элементов LSN	макс. 127 классических LSN-элементов макс. 254 элементов LSN _{improved}
Линейный ток LSN	макс. 300 мА, в зависимости от конфигурации и типа кабеля,
Дополнительное питание AUX (28 В пост. тока)	макс. 500 мА при кольцевом подключении LSN (ERT-Technik) или 2 x макс. 500 мА при 2 шлейфах
Класс защиты	IP30 / IEC 60529
Стандарты по технике безопасности	IEC 60950 / EN 60950
Устойчивость к электромагнитным помехам	EN 50130-4
Электромагнитное излучение	EN 61000-6-3
Допустимая рабочая температура	-5 °C . . . 50 °C
Допустимая температура при хранении	-20 °C . . . 60 °C
Допустимая относительная влажность	макс. 95 % без образования конденсата
Материал корпуса и краска	Пластмасса ABS, (UL94 V-0), полуматовая, антрацит, RAL 7016
Габариты (В x Ш x Г)	прибл. 127 x 96 x 60 мм
Вес	прибл. 225 г

Funktionsbeskrivning

Modulen gör det möjligt att ansluta en LSN-ring med upp till 254 LSN_{improved} - enheter eller 127 klassiska LSN - enheter, med en maximal belastning på 300 mA.

Stiftschema

Pos.	Text	Anslutning	
		LSN-ring	LSN-stift
1	AUX1 +	Extern strömförsörjning	Extern strömförsörjning stift 1
2	AUX1 -		
3	LSN a1-	LSN a1- Utgående	Stift 1 LSN a1-
4	LSN b1+	LSN b1+ Utgående	Stift 1 LSN b1+
5	AUX2 +	Extern strömförsörjning***	Extern strömförsörjning stift 2
6	AUX2 -		
7	LSN a2-	LSN a2- Inkommande	Stift 2 LSN a2-
8	LSN b2+	LSN b2+ Inkommande	Stift 2 LSN b2+

*** Endast vid skiljeelement som är isatta i ringen(ERT-teknik) får extern strömförsörjning återföras till AUX2!
[lämpliga är t.ex. YBO-R/SCI-skiljeelement]

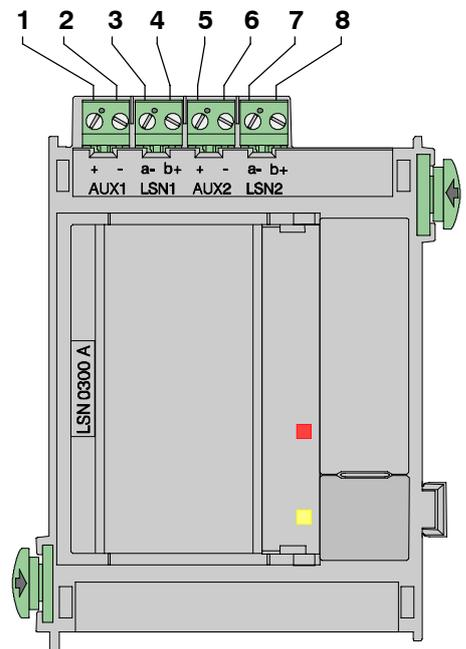

Tekniska data

Manöver- och indikeringsselement	2 lysdioder (1x röd, larm/1x gul, fel) 1 knapp (lamptest)
Ingångsspänning	+20 V DC . . . +30 V DC / +5 V DC ± 5 %
Utgångsspänning: - LSN-vilospanning - LSN-sändspänning - Extern strömförsörjning AUX	30 ± 1,0 V DC 30 ± 1,0 V DC + 1,6 ± 0,15 V DC (spänningslyft) 28 ± 1,0 V DC
Maximal strömförbrukning	1750 mA vid 24 V DC
Nom. Strömförbrukning: - Modul - LSN - AUX	39 mA vid 24 V DC 1,7 x strömförbrukning för LSN-enheter 1,2 x extern strömförsörjning AUX
Ledningslängd	max. 1600 m, beroende på konfiguration och kabeltyp
Antal LSN-enheter	max. 127 klassiska LSN-enheter max. 254 LSN _{improved} -enheter
Linjeström LSN	max. 300 mA, beroende på konfiguration och kabeltyp
Extern strömförsörjning AUX (28 V DC)	max. 500 mA vid en LSN-ring (ERT-teknik) resp. 2 x max. 500 mA vid 2 stift
Skyddstyp	IP30 / IEC 60529
Säkerhetsstandarder	IEC 60950/EN 60950
EMV-störtlighet	EN 50130-4
EMV-störningsutsändning	EN 61000-6-3
Tillåten driftstemperatur	-5 °C . . . 50 °C
Tillåten lagringstemperatur	-20 °C . . . 60 °C
Tillåten relativ fuktighet	max. 95 % icke-kondenserande
Kåpans material och färg	ABS-plast (UL94 V-0), sidenmatt antracit, RAL 7016
Mått (H x B x D)	ca. 127 x 96 x 60mm
Vikt	ca. 225 g

Opis funkcija

Modul omogućava spajanje LSN zatvorene petlje sa do 254 LSNimproved - elemenata ili 127 klasičnih LSN - elemenata pri maksimalnoj linijskoj struji od 300 mA.

Raspored stezaljki

Pol.	Oznaka	Priključak	
		LSN-zatvorena petlja	LSN-linija
1	AUX1 +	Napajanje dodatnim naponom	Napajanje dodatnim naponom linije 1
2	AUX1 -		
3	LSN a1-	LSN a1- izlazna	Linija 1 LSN a1-
4	LSN b1+	LSN b1+ izlazna	Linija 1 LSN b1+
5	AUX2 +	Napajanje dodatnim naponom***	Napajanje dodatnim naponom linija 2
6	AUX2 -		
7	LSN a2-	LSN a2- ulazna	Linija 2 LSN a2-
8	LSN b2+	LSN b2+ ulazna	Linija 2 LSN b2+

*** Samo kod zatvorene petlje sa umetnutim izolatorima kratkog spoja (ERT-tehnologije) dozvoljeno je sniavanje dodatnog napona prema AUX2! [odgovarajući su na primer YBO-R/SCI-izolatori kratkog spoja]

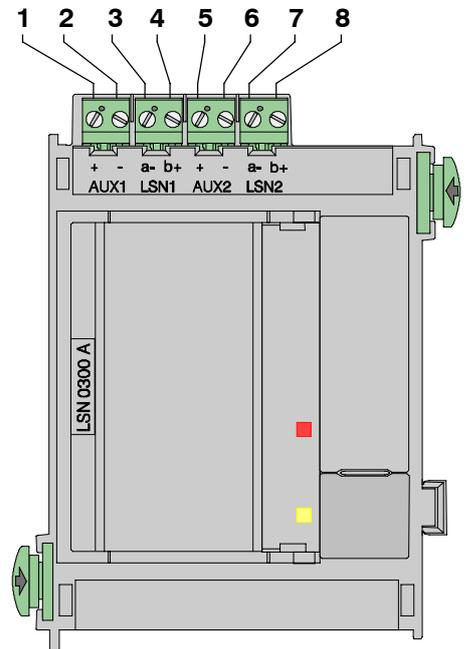

Tehnički podaci

Elementi za prikazivanje i rukovanje	2 LED svetleće diode (1 x crvena, alarm/ 1 x utra, smetnja) 1 taster (LED - test)
Ulazni napon	+20 V DC (jednosmerne struje) . . . +30 V DC / +5 V DC ± 5 %
Izlazni napon: - LSN-napon mirovanja - LSN-odašiljački napon - Dodatno napajanje AUX	30 ± 1,0 V DC 30 ± 1,0 V DC + 1,6 ± 0,15 V DC (podizanje napona) 28 ± 1,0 V DC
Maksimalna potrošnja struje	1750 mA pri 24 V DC
Nom. potrošnja struje: - modula - LSN-a - AUX-a	39 mA pri 24 V DC 1,7 x potrošnja struje LSN-elemenata 1,2 x dodatno napajanje AUX
Duina kabla	maks. 1600 m, zavisno od konfiguracije i vrste kabla
Broj LSN elemenata	maks. 127 klasičnih LSN elemenata maks. 254 LSN _{poboljšanih} elemenata
Linijska struja LSN	maks. 300 mA, zavisno od konfiguracije i vrste kabla
Dodatno napajanje AUX (28 V DC)	maks. 500 mA kod LSN zatvorene petlje (ERT-tehnologija) tj. 2 x maks. 500 mA kod 2 linije
Vrsta zaštite	IP30 / IEC 60529
Bezbednosni standardi	IEC 60950 / EN 60950
EMV-otpornost na smetnje	EN 50130-4
EMV-emitiranje smetnji	EN 61000-6-3
Dozvoljena radna temperatura	-5 °C . . . 50 °C
Dozvoljena temperatura za skladištenje	-20 °C . . . 60 °C
Dozvoljena relativna vlanost	maks. 95 % bez kondenzacije
Materijal i boja kućišta	ABS plastika, (UL94 V-0), polusjajni antracit, RAL 7016
Dimenzije (V x Š x D)	približno 127 x 96 x 60 mm
Teina	oko 225 g

Opis delovanja

Modul omogoča vklop sklenjenega lokalnega varnostnega omrežja (LSN) do 254 LSN_{improved} – elementi ali 127 obiajnih LSN – elementi pri največjem linijskem toku 300 mA.

Razporeditev prikljunitvenih sponk

Položaj	Oznake	Prikljuek	
		Sklenjen LSN	Prekinjen LSN
1	AUX1 +	dodatna napajalna napetost	dodatna napajalna napetost veje 1
2	AUX1 -		
3	LSN a1-	LSN a1- odvod	Veja 1 LSN a1-
4	LSN b1+	LSN b1+ odvod	Veja 1 LSN b1+
5	AUX2 +	dodatna napajalna napetost***	dodatna napajalna napetost veje 2
6	AUX2 -		
7	LSN a2-	LSN a2- dovod	Veja 2 LSN a2-
8	LSN b2+	LSN b2+ dovod	Veja 2 LSN b2+

*** Dodatna napetost do AUX2 je lahko povratna samo pri izolatorjih v zanki (ERT-tehnika)! [primerni so npr. izolatorji YBO-R/SCI]

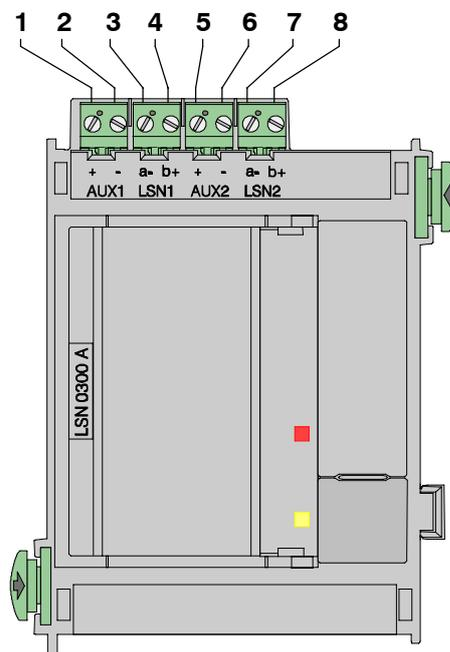

Tehnični podatki

Nadzorni in prikazovalni elementi	2 indikatorja LED (1 rde, alarm/1 rumen, okvara) 1 tipka (preizkus diode LED)
Vhodna napetost	+20 V DC . . . +30 V DC/+5 V DC ± 5 %
Izhodna napetost: - mirovna napetost LSN-ja - oddajana napetost LSN-ja - dodatno napajanje AUX	30 ± 1,0 V DC 30 ± 1,0 V DC + 1,6 ± 0,15 V DC (dvig napetosti) 28 ± 1,0 V DC
Najveja poraba	4010 mA pri 24 V DC
Nom. poraba: - modul - LSN - AUX	260 mA pri 24 V DC 1,7 x poraba LSN-elementov 1,2 x dodatno napajanje AUX-a
Dolžina kabla	najve 3000 m, glede na konfiguracijo in vrsto kabla
Število LSN-elementov	najve 127 navadnih LSN-elementov najve 254 LSN _{improved} -elementov
Linijski tok LSN-ja	najve 300 mA, glede na konfiguracijo in vrsto kabla,
Dodatno napajanje AUX-a (28 V DC)	najve 500 mA pri sklenjenem LSN-ju (ERT-tehnika) oz. 2 x najve 500 mA pri 2 vejah
Vrsta zašite	IP30/IEC 60529
Varnostni standardi	IEC 60950/EN 60950
Odpornost proti elektromagnetnim motnjam (elektromagnetna združljivost)	EN 50130-4
Neželeno elektromagnetno oddajanje (elektromagnetna združljivost)	EN 61000-6-3
Dovoljena delovna temperatura	-5 °C . . . 50 °C
Dovoljena temperatura pri skladiščenju	-20 °C . . . 60 °C
Dovoljena relativna vlažnost	najve 95 %, brez kondenzacije
Material ohišja in barva	ABS umetna masa, (UL94 V-0), antracitna mat svilen barva, RAL 7016
Mere (V x Š x G)	približno 127 x 96 x 60 mm
Teža	približno 2250 g

Fonksiyon açıklaması

Bu modül 254 LSN_{improved} - veya 127 klasik elemana kadar maksimum 300 mA hat akımında bir LSN devresinin devreye sokulmasını sağlar.

Terminal yerleimi

Poz.	Etiketleme	Balant	
		LSN devresi	LSN dal
1	AUX1 +	Ek gerilim beslemesi	Ek gerilim beslemesi, Dal 1
2	AUX1 -		
3	LSN a1-	LSN a1- giden	Dal 1 LSN a1-
4	LSN b1+	LSN b1+ giden	Dal 1 LSN b1+
5	AUX2 +	Ek gerilim beslemesi***	Ek gerilim beslemesi, Dal 2
6	AUX2 -		
7	LSN a2-	LSN a2- gelen	Dal 2 LSN a2-
8	LSN b2+	LSN b2+ gelen	Dal 2 LSN b2+

*** Sadece devreye eklenmi izole edilmi elemanların (ERT Teknii) ek gerilimi AUX2'e geri dönebilir.
[örn: YBO-R/SCI izolatörleri uygundur]

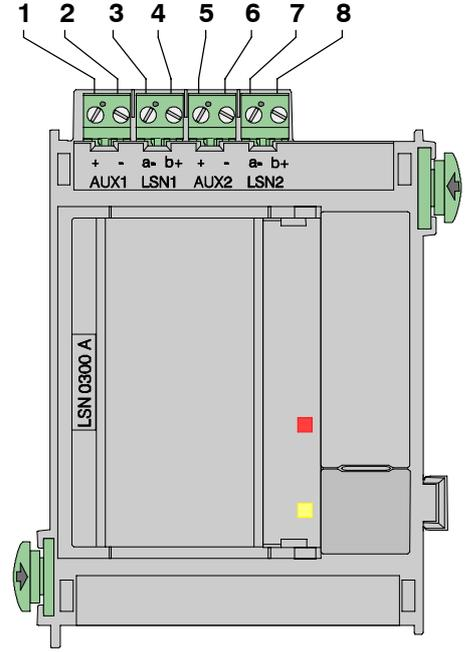

Teknik Özellikler

Kumanda ve gösterge elemanlar	2 adet LED (1 x kırmızı, alarm / 1 x sarı, hata) 1 tu (LED testi)
Giri gerilimi	+20 V DC . . . +30 V DC / +5 V DC ± 5 %
Çıkı gerilimi: - LSN stand-by gerilimi - LSN iletim gerilimi - Ek besleme AUX	30 ± 1,0 V DC 30 ± 1,0 V DC + 1,6 ± 0,15 V DC (gerilim stroku) 28 ± 1,0 V DC
Maksimum akım değeri	1750 24 V DC'deki mA değeri
Nom. Akım değeri: - Modül - LSN - AUX	39 24 V DC'deki mA değeri 1,7 x LSN Elemanların çektii akım 1,2 x ek besleme AUX
Hat uzunluğu	maks. 1600 m, konfigürasyona ve kablo tipine bal olarak
LSN eleman sayısı	maks. 127 klasik LSN eleman maks. 254 LSN _{improved} eleman
LSN hat akımı	maks. 300 mA, konfigürasyona ve kablo tipine bal olarak,
Ek besleme AUX (28 V DC)	bir LSN devresindeki maks. 500 mA (ERT tekniği) veya 2 dalda 2 x maks. 500 mA
Koruma tipi	IP30 / IEC 60529
Güvenlik standartları	IEC 60950 / EN 60950
EMC dayanıklılık	EN 50130-4
EMC parazit yayma	EN 61000-6-3
Müsaade edilen çalışma sıcaklığı	-5 °C . . . 50 °C
Müsaade edilen depolama sıcaklığı	-20 °C . . . 60 °C
Müsaade edilen bal nem	maks. %95 (bulamayacak)
Muhafaza malzemesi ve rengi	ABS plastik, (UL94 V-0), mat antrasit, RAL 7016
Boyutlar (H x B x T)	yakl. 127 x 96 x 60mm
Arlık	yakl. 225 g



Bosch Sicherheitssysteme GmbH
Robert-Koch-Straße 100
D-85521 Ottobrunn

Info-Service
www.bosch-sicherheitssysteme.de
info.service@de.bosch.com