

# Installation Manual

**DSC**<sup>™</sup>  
**Power 832**<sup>™</sup>

WITH



---

S E C U R I T Y   S Y S T E M

**PC5015**

Version 2.2

DLS-1 version 6.5 or later

**WARNING** This manual contains information on limitations regarding product use and function and information on the limitations as to liability of the manufacturer. The entire manual should be carefully read.

## FCC COMPLIANCE STATEMENT

**CAUTION:** Changes or modifications not expressly approved by Digital Security Controls Ltd. could void your authority to use this equipment.

This equipment has been tested and found to comply with the limits for a Class B digital device, pursuant to Part 15 of the FCC Rules. These limits are designed to provide reasonable protection against harmful interference in a residential installation. This equipment generates, uses and can radiate radio frequency energy and, if not installed and used in accordance with the instructions, may cause harmful interference to radio communications. However, there is no guarantee that interference will not occur in a particular installation. If this equipment does cause harmful interference to radio or television reception, which can be determined by turning the equipment off and on, the user is encouraged to try to correct the interference by one or more of the following measures:

- Re-orient the receiving antenna.
- Increase the separation between the equipment and receiver.
- Connect the equipment into an outlet on a circuit different from that to which the receiver is connected.
- Consult the dealer or an experienced radio/television technician for help.

The user may find the following booklet prepared by the FCC useful: "How to Identify and Resolve Radio/Television Interference Problems". This booklet is available from the U.S. Government Printing Office, Washington D.C. 20402, Stock # 004-000-00345-4.

## IMPORTANT INFORMATION

This equipment complies with Part 68 of the FCC Rules. On the side of this equipment is a label that contains, among other information, the FCC registration number of this equipment.

**NOTIFICATION TO TELEPHONE COMPANY** The customer shall notify the telephone company of the particular line to which the connection will be made, and provide the FCC registration number and the ringer equivalence of the protective circuit.

FCC Registration Number: F53CAN-32104-AL-E

REN: 0.6B

USOC Jack: RJ31X

**TELEPHONE CONNECTION REQUIREMENTS** Except for the telephone company provided ringers, all connections to the telephone network shall be made through standard plugs and telephone company provided jacks, or equivalent, in such a manner as to allow for easy, immediate disconnection of the terminal equipment. Standard jacks shall be so arranged that, if the plug connected thereto is withdrawn, no interference to the operation of the equipment at the customer's premises which remains connected to the telephone network shall occur by reason of such withdrawal.

**INCIDENCE OF HARM** Should terminal equipment or protective circuitry cause harm to the telephone network, the telephone company shall, where practicable, notify the customer that temporary disconnection of service may be required; however, where prior notice is not practicable, the telephone company may temporarily discontinue service if such action is deemed reasonable in the circumstances. In the case of such temporary discontinuance, the telephone company shall promptly notify the customer and will be given the opportunity to correct the situation.

**ADDITIONAL TELEPHONE COMPANY INFORMATION** The security control panel must be properly connected to the telephone line with a USOC RJ-31X telephone jack.

The FCC prohibits customer-provided terminal equipment be connected to party lines or to be used in conjunction with coin telephone service. Interconnect rules may vary from state to state.

**CHANGES IN TELEPHONE COMPANY EQUIPMENT OR FACILITIES** The telephone company may make changes in its communications facilities, equipment, operations or procedures, where such actions are reasonably required and proper in its business. Should any such changes render the customer's terminal equipment incompatible with the telephone company facilities the customer shall be given adequate notice to the effect modifications to maintain uninterrupted service.

**RINGER EQUIVALENCE NUMBER (REN)** The REN is useful to determine the quantity of devices that you may connect to your telephone line and still have all of those devices ring when your telephone number is called. In most, but not all areas, the sum of the RENs of all devices connected to one line should not exceed five (5.0). To be certain of the number of devices that you may connect to your line, you may want to contact your local telephone company.

**EQUIPMENT MAINTENANCE FACILITY** If you experience trouble with this telephone equipment, please contact the facility indicated below for information on obtaining service or repairs. The telephone company may ask that you disconnect this equipment from the network until the problem has been corrected or until you are sure that the equipment is not malfunctioning.

Digital Security Controls Ltd. 160 Washburn St., Lockport, NY 14094

# Table of Contents

<b>Section 1: Introduction</b>		<b>Section 5: Program Descriptions</b>		
1.1	PC5015 Specifications .....	1	5.1 Zone Definitions .....	22
1.2	Additional Devices .....	2	5.2 Zone Attributes .....	23
1.3	Out of the Box .....	4	5.3 Communicator - Dialing .....	24
<b>Section 2: Getting Started</b>		5.4	Communicator - Phone Numbers .....	24
2.1	Installation Steps .....	5	5.5 Communicator - Account Numbers .....	25
2.2	Terminal Descriptions .....	5	5.6 Communicator - Reporting Formats .....	25
2.3	Keybus Operation and Wiring .....	7	5.7 Communicator - Reporting Codes .....	27
2.4	Current Ratings - Modules and Accessories .....	7	5.8 Downloading .....	28
2.5	Assigning Zones to Zone Expanders .....	8	5.9 Partitions/Zone Assignment .....	29
2.6	Keypad Assignment .....	9	5.10 Programmable Outputs .....	29
2.7	Enable Supervision .....	9	5.11 Telephone Line Monitor (TLM) .....	32
2.8	Removing Modules .....	10	5.12 Siren .....	32
2.9	Zone Wiring .....	10	5.13 Test Transmission .....	32
2.10	Keypad Zones .....	12	5.14 Fire, Auxiliary, Panic Keys .....	33
<b>Section 3: Keypad Commands</b>		5.15	Entry/Exit Delay Options .....	33
3.1	Access Codes .....	13	5.16 Event Buffer .....	34
3.2	Arming/Disarming .....	13	5.17 Swinger Shutdown .....	34
3.3	Auto Bypass .....	14	5.18 Daylight Savings Time .....	34
3.4	[★] Commands .....	14	5.19 Keypad Backlighting .....	34
3.5	Function Keys .....	17	5.20 Arming/Disarming Options .....	34
3.6	Global and Partition Keypad Operation .....	19	5.21 Automatic Arming .....	35
3.7	Features Available for the LCD5500Z .....	19	5.22 Keypad Lockout .....	36
<b>Section 4: How to Program</b>		5.23	Keypad Blanking .....	36
4.1	How to Enter Installer Programming .....	20	5.24 Loop Response .....	36
4.2	Programming Decimal Data .....	20	5.25 Keypad Tamper .....	36
4.3	Programming HEX Data .....	20	5.26 LINKS1000 Cellular Communicator .....	36
4.4	Programming Toggle Option Sections .....	21	5.27 Module Programming .....	37
4.5	Viewing Programming .....	21	5.28 Default (Factory) .....	37
			5.29 Installer Lockout .....	38
			5.30 Walk Test (Installer) .....	38
		<b>Appendix A: Reporting Codes</b>		<b>39</b>
		<b>Appendix B: Zone Reporting Codes</b>		<b>41</b>
		<b>Appendix C: Control Panel Wiring Diagram</b>		<b>42</b>
		<b>Appendix D: Modules Supported on the PC5015 v2.2</b>		<b>Inside back cover</b>

# LIMITED WARRANTY

Digital Security Controls Ltd. warrants the original purchaser that for a period of twelve months from the date of purchase, the product shall be free of defects in materials and workmanship under normal use. During the warranty period, Digital Security Controls Ltd. shall, at its option, repair or replace any defective product upon return of the product to its factory, at no charge for labour and materials. Any replacement and/or repaired parts are warranted for the remainder of the original warranty or ninety (90) days, whichever is longer. The original owner must promptly notify Digital Security Controls Ltd. in writing that there is defect in material or workmanship, such written notice to be received in all events prior to expiration of the warranty period.

## International Warranty

The warranty for international customers is the same as for any customer within Canada and the United States, with the exception that Digital Security Controls Ltd. shall not be responsible for any customs fees, taxes, or VAT that may be due.

## Warranty Procedure

To obtain service under this warranty, please return the item(s) in question to the point of purchase. All authorized distributors and dealers have a warranty program. Anyone returning goods to Digital Security Controls Ltd. must first obtain an authorization number. Digital Security Controls Ltd. will not accept any shipment whatsoever for which prior authorization has not been obtained.

## Conditions to Void Warranty

This warranty applies only to defects in parts and workmanship relating to normal use. It does not cover:

- damage incurred in shipping or handling;
- damage caused by disaster such as fire, flood, wind, earthquake or lightning;
- damage due to causes beyond the control of Digital Security Controls Ltd. such as excessive voltage, mechanical shock or water damage;
- damage caused by unauthorized attachment, alterations, modifications or foreign objects;
- damage caused by peripherals (unless such peripherals were supplied by Digital Security Controls Ltd.);
- defects caused by failure to provide a suitable installation environment for the products;
- damage caused by use of the products for purposes other than those for which it was designed;
- damage from improper maintenance;
- damage arising out of any other abuse, mishandling or improper application of the products.

Digital Security Controls Ltd.'s liability for failure to repair the product under this warranty after a reasonable number of attempts will be limited to a replacement of the product, as the exclusive remedy for breach of warranty. Under no circumstances shall Digital Security Controls Ltd. be liable for any special, incidental, or consequential damages based upon breach of warranty, breach of contract, negligence, strict liability, or any other legal theory. Such damages include, but are not limited to, loss of profits, loss of the product or any associated equipment, cost of capital, cost of substitute or replacement equipment, facilities or services, down time, purchaser's time, the claims of third parties, including customers, and injury to property.

## Disclaimer of Warranties

**This warranty contains the entire warranty and shall be in lieu of any and all other warranties, whether expressed or implied (including all implied warranties of merchantability or fitness for a particular purpose) And of all other obligations or liabilities on the part of Digital Security Controls Ltd. Digital Security Controls Ltd. neither assumes nor authorizes any other person purporting to act on its behalf to modify or to change this warranty, nor to assume for it any other warranty or liability concerning this product.**

**This disclaimer of warranties and limited warranty are governed by the laws of the province of Ontario, Canada.**

**WARNING:** Digital Security Controls Ltd. recommends that the entire system be completely tested on a regular basis. However, despite frequent testing, and due to, but not limited to, criminal tampering or electrical disruption, it is possible for this product to fail to perform as expected.

## Installer's Lockout

Any products returned to DSC which have the Installer's Lockout option enabled and exhibit no other problems will be subject to a service charge.

## Out of Warranty Repairs

Digital Security Controls Ltd. will at its option repair or replace out-of-warranty products which are returned to its factory according to the following conditions. Anyone returning goods to Digital Security Controls Ltd. must first obtain an authorization number. Digital Security Controls Ltd. will not accept any shipment whatsoever for which prior authorization has not been obtained.

Products which Digital Security Controls Ltd. determines to be repairable will be repaired and returned. A set fee which Digital Security Controls Ltd. has predetermined and which may be revised from time to time, will be charged for each unit repaired.

Products which Digital Security Controls Ltd. determines not to be repairable will be replaced by the nearest equivalent product available at that time. The current market price of the replacement product will be charged for each replacement unit.

# WARNING Please Read Carefully

## Note to Installers

This warning contains vital information. As the only individual in contact with system users, it is your responsibility to bring each item in this warning to the attention of the users of this system.

## System Failures

This system has been carefully designed to be as effective as possible. There are circumstances, however, involving fire, burglary, or other types of emergencies where it may not provide protection. Any alarm system of any type may be compromised deliberately or may fail to operate as expected for a variety of reasons. Some but not all of these reasons may be:

### ■ Inadequate Installation

A security system must be installed properly in order to provide adequate protection. Every installation should be evaluated by a security professional to ensure that all access points and areas are covered. Locks and latches on windows and doors must be secure and operate as intended. Windows, doors, walls, ceilings and other building materials must be of sufficient strength and construction to provide the level of protection expected. A reevaluation must be done during and after any construction activity. An evaluation by the fire and/or police department is highly recommended if this service is available.

### ■ Criminal Knowledge

This system contains security features which were known to be effective at the time of manufacture. It is possible for persons with criminal intent to develop techniques which reduce the effectiveness of these features. It is important that a security system be reviewed periodically to ensure that its features remain effective and that it be updated or replaced if it is found that it does not provide the protection expected.

### ■ Access by Intruders

Intruders may enter through an unprotected access point, circumvent a sensing device, evade detection by moving through an area of insufficient coverage, disconnect a warning device, or interfere with or prevent the proper operation of the system.

### ■ Power Failure

Control units, intrusion detectors, smoke detectors and many other security devices require an adequate power supply for proper operation. If a device operates from batteries, it is possible for the batteries to fail. Even if the batteries have not failed, they must be charged, in good condition and installed correctly. If a device operates only by AC power, any interruption, however brief, will render that device inoperative while it does not have power. Power interruptions of any length are often accompanied by voltage fluctuations which may damage electronic equipment such as a security system. After a power interruption has occurred, immediately conduct a complete system test to ensure that the system operates as intended.

### ■ Failure of Replaceable Batteries

This system's wireless transmitters have been designed to provide several years of battery life under normal conditions. The expected battery life is a function of the device environment, usage and type. Ambient conditions such as high humidity, high or low temperatures, or large temperature fluctuations may reduce the expected battery life. While each transmitting device has a low battery monitor which identifies when the batteries need to be replaced, this monitor may fail to operate as expected. Regular testing and maintenance will keep the system in good operating condition.

### ■ Compromise of Radio Frequency (Wireless) Devices

Signals may not reach the receiver under all circumstances which could include metal objects placed on or near the radio path or deliberate jamming or other inadvertent radio signal interference.

### ■ System Users

A user may not be able to operate a panic or emergency switch possibly due to permanent or temporary physical disability, inability to reach the device in time, or unfamiliarity with the correct operation. It is important that all system users be trained in the correct operation of the alarm system and that they know how to respond when the system indicates an alarm.

### ■ Smoke Detectors

Smoke detectors that are a part of this system may not properly alert occupants of a fire for a number of reasons, some of which follow. The smoke detectors may have been improperly installed or positioned. Smoke may not be able to reach the smoke detectors, such as when the fire is in a chimney, walls or roofs, or on the other side of closed doors. Smoke detectors may not detect smoke from fires on another level of the residence or building.

Every fire is different in the amount of smoke produced and the rate of burning. Smoke detectors cannot sense all types of fires equally well. Smoke detectors may not provide timely warning of fires caused by carelessness or safety hazards such as smoking in bed, violent explosions, escaping gas, improper storage of flammable materials, overloaded electrical circuits, children playing with matches or arson.

Even if the smoke detector operates as intended, there may be circumstances when there is insufficient warning to allow all occupants to escape in time to avoid injury or death.

### ■ Motion Detectors

Motion detectors can only detect motion within the designated areas as shown in their respective installation instructions. They cannot discriminate between intruders and intended occupants. Motion detectors do not provide volumetric area protection. They have multiple beams of detection and motion can only be detected in unobstructed areas covered by these beams. They cannot detect motion which occurs behind walls, ceilings, floor, closed doors, glass partitions, glass doors or windows. Any type of tampering whether intentional or unintentional such as masking, painting, or spraying of any material on the lenses, mirrors, windows or any other part of the detection system will impair its proper operation.

Passive infrared motion detectors operate by sensing changes in temperature. However their effectiveness can be reduced when the ambient temperature rises near or above body temperature or if there are intentional or unintentional sources of heat in or near the detection area. Some of these heat sources could be heaters, radiators, stoves, barbecues, fireplaces, sunlight, steam vents, lighting and so on.

### ■ Warning Devices

Warning devices such as sirens, bells, horns, or strobes may not warn people or waken someone sleeping if there is an intervening wall or door. If warning devices are located on a different level of the residence or premise, then it is less likely that the occupants will be alerted or awakened. Audible warning devices may be interfered with by other noise sources such as stereos, radios, televisions, air conditioners or other appliances, or passing traffic. Audible warning devices, however loud, may not be heard by a hearing-impaired person.

### ■ Telephone Lines

If telephone lines are used to transmit alarms, they may be out of service or busy for certain periods of time. Also an intruder may cut the telephone line or defeat its operation by more sophisticated means which may be difficult to detect.

### ■ Insufficient Time

There may be circumstances when the system will operate as intended yet the occupants will not be protected from the emergency due to their inability to respond to the warnings in a timely manner. If the system is monitored, the response may not occur in time to protect the occupants or their belongings.

### ■ Component Failure

Although every effort has been made to make this system as reliable as possible, the system may fail to function as intended due to the failure of a component.

### ■ Inadequate Testing

Most problems that would prevent an alarm system from operating as intended can be found by regular testing and maintenance. The complete system should be tested weekly and immediately after a break-in, an attempted break-in, a fire, a storm, an earthquake, an accident, or any kind of construction activity inside or outside the premises. The testing should include all sensing devices, keypads, consoles, alarm indicating devices and any other operational devices that are part of the system.

### ■ Security and Insurance

Regardless of its capabilities, an alarm system is not a substitute for property or life insurance. An alarm system also is not a substitute for property owners, renters, or other occupants to act prudently to prevent or minimize the harmful effects of an emergency situation.

# System Introduction

## S E C T I O N 1

### 1.1 PC5015 Specifications

#### **Flexible Zone Configuration:**

- 8 Fully Programmable Zones
- 38 Access Codes: 32 User, 1 System Master, 2 Partition Master, 2 Duress and 1 maintenance
- Expandable to 32 Zones
- Keypads with zone inputs available (PC5508Z, PC5516Z, PC5532Z, LCD5500Z)
- Hardwired expansion available using the PC5108 Eight Zone Expansion Module and the PC5700 Fire Module
- Wireless expansion available using the PC5132 Wireless Zone Expansion Module (up to 32 wireless zones, 900MHz, True Spread Spectrum Technology, Fully Supervised)
- Normally Closed, Single EOL, or Double EOL zone supervision
- 2-Wire Smoke Input (via PGM2 input)
- 28 Zone Types, 8 Programmable Zone Options
- 2 Partitions

#### **Audible Alarm Output:**

- 700mA Supervised Bell Output (current limited at 3 amps), 12 Vdc
- Steady or Pulsed Output

#### **EEPROM Memory:**

- Will not lose programming or system status on complete AC and Battery failure

#### **Programmable Outputs:**

- Up to 14 Programmable Voltage Outputs, 24 programmable options
- One High Current (300 mA) PGM output with 2-wire smoke detector capability on main panel
- Maximum Loop Current is 1.5 mA when the 2-wire smoke detector configuration is used
- One Low Current (50 mA) PGM output on main panel
- Eight Additional Low Current (50 mA) PGM outputs available using the PC5208 module
- Four High Current (1 Amp) PGM outputs Available Using the PC5204 module
- One PC5204 Output Fully Supervised for Siren Output

#### **Powerful 1.5 Amp Regulated Power Supply:**

- 550 mA Auxiliary Supply, 12 Vdc
- Positive Temperature Coefficient (PTC) components replace fuses
- Supervision for loss of AC Power, Low Battery
- Internal Clock Locked to AC Power Frequency

#### **Power Requirements:**

- Transformer = 16.5 VAC, 40VA
- Battery = 12 volt 4 Ah minimum rechargeable sealed lead acid

#### **Remote Keypad Specifications:**

- 8 Different Keypads Available:
  - PC5508(Z) 8 Zone LED Keypad
  - PC5532(Z) 32 Zone LED Keypad
  - PC5516(Z) 16 Zone LED Keypad
  - LCD5500(Z) Alphanumeric Keypad
- Each Keypad has 5 Fully Programmable Function Keys
- Four Wire (Quad) Connection to Keybus
- "Z" version keypads have zone input
- Connect up to 8 Keypads
- Built in Piezoelectric Buzzer

#### **Digital Communicator Specifications:**

- Supports all Major Formats including SIA and Contact ID and Residential Dial
- Split Reporting of Selected Transmissions to Each Telephone Number
- 3 Programmable Phone Numbers
  - 2 Account numbers
- Supports LINKS1000 Cellular Communication
  - DTMF and Pulse Dialing
- DPDT Line Seizure
  - Anti-jam Feature
- Event-Initiated Personal Paging

#### **System Supervision Features**

The PC5015 continuously monitors a number of possible trouble conditions including:

- AC Power Failure
- Telephone Line Trouble
- Loss of Internal Clock
- Failure to Communicate
- Trouble by Zone
- Low Battery Condition
- AUX Power Supply Fault
- Module Fault (Supervisory or Tamper)
- Fire Trouble
- Bell Output Trouble
- Tamper by Zone
- Camera Troubles via DLM-4L

**False Alarm Prevention Features**

- Audible Exit Delay
- Audible Exit Fault
- Urgency on Entry Delay
- Quick Exit
- Swinger Shutdown
- Recent Closing Transmission
- Cross Zone Alarm
- Burglary-verified timer
- Double Hit Timer
- Communication Delay
- Rotating Keypress Buffer

**Additional Features**

- Auto Arm by Partition at Specified Time each day of the week
- Keypad Activated Alarm Output and Communicator Test
- Keypad Lockout
- Audio Capability using the PC5928 Audio Interface Module which allows local intercom and Central Station 2-Way Listen in.
- All modules connect to the system via a four wire Keybus up to 1000'/305m from main panel
- Event Buffer can be printed using PC5400 RS232 Serial Interface module
- Supports the Escort5580 Voice Prompt Module with Automation/Lighting Control
- 128 Event Buffer, Time and Date Stamped
- Upload/Download Capability
- Daylight Savings time option
- Downlook support (DLM-4L: v1.0L and PC5108L)

**1.2 Additional Devices**

In addition to the information below, see the inside back cover for a DSC Module Compatibility table.

**1.2.1 Keypads**

A maximum of eight (8) keypads can be connected to the control panel and can be any combination of the following listed. Different keypads (with function keys) can be used for different size systems: 8 zone, 16 zone and 32 zone.

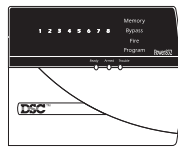

PC5508/PC5508Z  
8 zone LED keypad

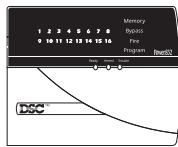

PC5516/PC5516Z  
16 zone LED keypad

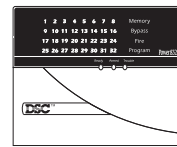

PC5532/PC5532Z  
32 zone LED keypad

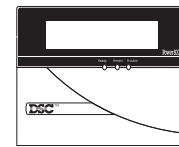

LCD5500/LCD5500Z  
LCD keypad

**1.2.2 PC5108 Eight Zone Expander Module**

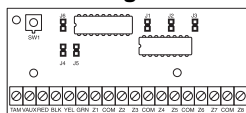

Eight zone expander module can be used to increase the number of zones on the system. Up to 3 modules can be connected to increase the system zones to a maximum of 32. (See *PC5108 Installation Instructions Sheet*.)

**1.2.3 PC5132 Wireless Receiver Module**

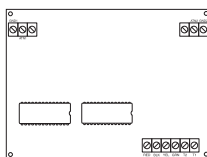

The PC5132 Wireless Receiver module can be used to connect up to 32 wireless devices. All devices are spread spectrum, 900 MHz, fully supervised and use standard 'AAA' or 'AA' alkaline batteries. (See *PC5132 Installation Manual for details*.)

Additional wireless devices are available:

**WLS904 Wireless Motion Detector**

The wireless Motion Detector can be used in conjunction with the PC5132 Wireless Receiver to include wireless space protection. The unit comes with four 'AAA' batteries.

**WLS906 Wireless Smoke Detector**

The wireless Smoke Detector can be used in conjunction with the PC5132 Wireless Receiver to include wireless smoke detection. The unit comes with six 'AA' batteries.

**WLS907 Wireless Slimline Universal Transmitter**

The wireless Slimline Universal Transmitter can be used with the PC5132 Wireless Receiver to add wireless door or window contacts in a smaller package. The unit comes with three 'AAA' batteries and has built-in contacts.

**WLS908 Wireless Panic Pendant**

The wireless Panic Pendant can be used in conjunction with the PC5132 Wireless Receiver to include personal wireless protection. The unit comes with 1 mini 12V battery (not user changeable).

**WLS909 Wireless Key**

The Wireless Key can be used in conjunction with the PC5132 Wireless Receiver to include a simple and mobile method of arming and disarming the system. The unit comes with three Photo/Electronic 1.5V batteries. This system can have a maximum of 16 Wireless Keys.

**WLS910 Wireless Handheld Keypad**

The wireless Handheld Keypad can be used in conjunction with the PC5132 Wireless Receiver to include a simple and mobile method of arming and disarming the system. The unit comes with three 'AAA' batteries. The system can have a maximum of four wireless Handheld Keypads.

**1.2.4 PC5204 Power Supply Output Module**

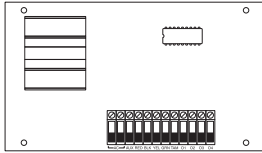

The PC5204 can provide up to 1 Amp of additional power for modules or devices connected to the control panel. The module requires a 16.5 volt AC 40 VA transformer and 4 AH battery. In addition, the module provides 4 programmable high current voltage outputs. (See *PC5204 Installation Instructions for details.*)

**1.2.5 PC5208 Eight Low Current Output Module**

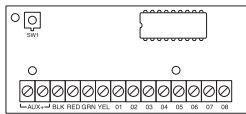

Adds eight programmable low current outputs (50 mA) to the control. (See *PC5208 Installation Instructions for details.*)

**1.2.6 Escort5580 Module**

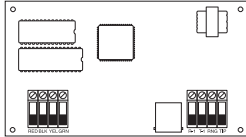

This Escort5580 module will turn any touch tone phone into a fully functional keypad. The module also includes a built-in interface to control up to 32 line carrier type devices for lighting and temperature control (See *Escort5580 Installation Manual for details.*)

**1.2.7 PC5928 Audio Interface Module (This device is not UL Listed)**

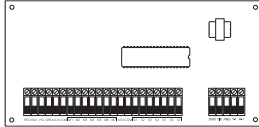

The PC5928 Audio Interface module is a simple way to incorporate paging, intercom, baby listen-in and door answer to the PC5015 control panel. The module also has built-in two-way voice capability for central station (See *PC5928 Installation Manual for details.*)

Three additional devices are available: **(These devices are not UL Listed)**

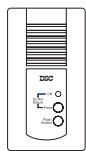

**PC5921 Intercom Audio Station** can be used in conjunction with the PC5928 Audio Interface Module.

**PC5921 EXT Door Box Audio Station** can be used in conjunction with the PC5928 Audio Interface Module.

**PC5921 EXT/R Door Box Audio Station** can be used in conjunction with the PC5928 Audio Interface Module. The Door Box contains a relay so the normal door bell can be used instead of the internal one generated by the PC5928 module.

**1.2.8 PC5400 Printer Module**

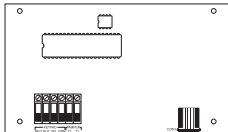

This PC5400 Printer Module will allow the panel to print out all events that occur on the system to any serial printer. All events will be printed with the Partition, time, date and the event that occurred. (See *PC5400 Installation Manual for details.*)

**1.2.9 LINKS1000 Cellular Communicator**

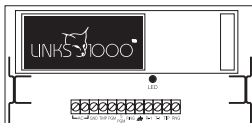

The LINKS1000 Cellular Communicator provides an efficient, cost-effective method for adding cellular back up. The unit comes in its own cabinet with antenna and requires a separate battery and transformer (See *Section 5.26 "LINKS1000 Cellular Communicator"*).

**1.2.10 Download Support: PC5108L and DLM-4L v1.0L (This device is not UL Listed)**

The PC5108L will expand the control panel's zone capability by adding eight fully programmable zone inputs. The module will also act as an interface between the DLM-4L v1.0L Video Transmission module and the PC5015 v2.2 alarm control panel. The PC5108L is also an 8-camera video switcher.

For more information on either module, see their respective installation manuals.

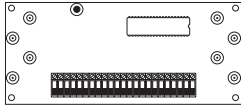

PC5108L

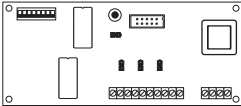

DLM-4L v1.0L

**1.2.11 PC5700 Fire Module**

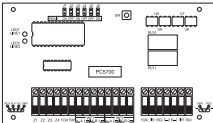

This is a zone expansion module with four general purpose zone inputs, two Class A supervisory waterflow zone inputs, ground fault detection and dual-supervised telephone line inputs.

**1.2.12 Cabinets**

Several different cabinets are available for the PC5015 modules. They are as follows:

**PC5003C** Main Control Cabinet for the PC5015 main panel. Dimensions 288mm x 298mm x 78mm / 11.3" x 11.7" x 3" approximately.

**PC5002C** Cabinet to house the PC5204 Power Supply Output Module. Dimensions 213mm x 235mm x 78mm / 8.4" x 9.25" x 3" approximately.

**PC5004C** Cabinet to house the Escort5580 Module and PC5400 Printer Module. Dimensions 229mm x 178mm x 65mm / 9" x 7" x 2.6" approximately.

**PC5001C** Cabinet to house the PC5108 Zone Expander Module and the PC5208 Eight Low Current Output Module. Dimensions 153mm x 122mm x 38mm / 6" x 4.8" x 1.5" approximately.

**PC5001CP** Plastic Cabinet to house the PC5108 Zone Expander Module and the PC5208 Eight Low Current Output Module. Dimensions 146mm x 105mm x 25.5mm / 5.75" x 4.2" x 1" approximately.

**1.2.13 Backplates**

There are two different backplates available for keypads to locate an Audio Station next to the keypad:

**PC55BP1 Backplate**

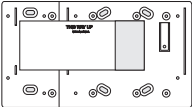

This backplate is to be used when an Audio Station is to be located next to a keypad. Dimensions 208mm x 115mm x 18mm / 8.2" x 4.5" x 0.25" approximately.

**PC55BP2 Backplate**

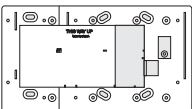

This backplate is to be used when an Audio Station is to be located next to a keypad. In addition the backplate will allow you to mount a PC5108 Zone Expander Module or the PC5208 Eight Low Current Output Module. Dimensions 208mm x 115mm x 18mm / 8.2" x 4.5" x 0.7" approximately.

**1.3 Out of the Box**

Verify that the following equipment is included in your system:

- one PC5015 main control cabinet
- one PC5015 circuit board
- one PC55XX(Z) / LCD5500(Z) keypad
- one set of manuals (Installation Manual, one Programming Worksheet Manual and one Instruction Manual for the end user
- one hardware pack consisting of:
  - five plastic circuit board standoffs
  - seventeen 5600 ohm (5.6K) resistors
  - one 2200 ohm (2.2K) resistor
  - one 1000 ohm (1K) resistor



# Getting Started

## S E C T I O N 2

The following sections provide a complete description of how to wire and configure devices and zones.

### 2.1 Installation Steps

The following steps are provided to assist with the installation of the panel. It is suggested that you read over this section briefly to get an overall understanding of the order of installation. Once this is done carefully work through each step. Working from this plan will help reduce problems and reduce the overall installation time required.

#### Step 1 Create a Layout

Draw a rough sketch of the building and include all alarm detection devices, zone expanders, keypads and all other modules that are required.

#### Step 2 Mounting the Panel

Locate the panel in a dry area, preferably located near an unswitched AC power source and the incoming telephone line. **Before attaching the cabinet to the wall be sure to press the five circuit board mounting studs into the cabinet from the back.**

---

**!** *Complete all wiring before applying AC or connecting the battery.*

---

#### Step 3 Wiring the Keybus (Section 2.3)

Wire the Keybus to each of the modules following the guidelines provided.

#### Step 4 Assigning Zones to Zone Expanders (Section 2.5)

If zone expander modules are being used the modules must be configured so the panel knows which zones are assigned to each expander. Follow the guideline provided to assign zones to expanders.

#### Step 5 Zone Wiring (Section 2.9)

Power down the control panel and complete all zone wiring. Follow the guidelines provided in Section 2.9 to connect zones using normally closed loops, single EOL resistor, double EOL resistors, Fire zones and Keyswitch Arming zones.

#### Step 6 Completing Wiring

Complete all other wiring including bells or sirens, phone line connections, ground connections or any other wiring necessary. Follow the guidelines provided in Section 2.2 "Terminal Descriptions".

#### Step 7 Power up the Control Panel

Once all zone wiring and Keybus wiring is complete, power up the control panel.

---

**!** *The panel will not power up if only the battery is connected.*

---

#### Step 8 Keypad Assignment (Section 2.6)

Keypads must be assigned to different addresses to be properly supervised. Follow the guideline provided in Section 2.6 to assign keypads.

#### Step 9 Enabling Supervision (Section 2.7)

After all modules have been wired to the Keybus, supervision must be enabled. Once supervision is enabled, the panel will be able to indicate module communication faults. Follow the guidelines provided in Section 2.7.

#### Step 10 Programming the System (Sections 4 and 5)

Section 4.0 provides a complete description of how to program the panel. Section 5.0 contains complete descriptions of the various programmable features, what options are available and how the options function. The Programming Work Sheets should be filled out completely before attempting to program the system.

#### Step 11 Testing the System

Test the panel completely to ensure that all features and functions are operating as programmed.

### 2.2 Terminal Descriptions

#### AC Terminals - AC

The panel requires a 16.5 volt, 40 VA transformer. Connect the transformer to an unswitched AC source and connect the transformer to these terminals.

---

**!** *Do not connect the transformer until all other wiring is complete.*

---

#### Battery Connection

The battery is used to provide back up power in the event of an AC power failure and to provide additional current when the panel demands exceed the power output of the transformer, such as when the panel is in alarm.

---

**!** *Do not connect the battery until all other wiring is complete.*

---

Connect the RED battery lead to the positive of the battery, the BLACK battery lead to the negative.

**Auxiliary Power Terminals - AUX+ and GND**

These terminals provide up to 550 mA of additional current at 12 Vdc for devices requiring power. Connect the positive side of any device requiring power to the AUX+ terminal, the negative side to GND. The AUX output is protected; if too much current is drawn from these terminals (wiring short) the panel will temporarily shut off the output, until the problem is corrected.

**Bell Output Terminals - BELL+ and BELL-**

These terminals provide up to 3 Amps of current at 12 Vdc (with stand-by battery; 700 mA continuous) for powering bells, sirens, strobes or other warning type equipment. Connect the positive side of any alarm warning device to BELL+, the negative side to BELL-. The BELL output is protected; if too much current is drawn from these terminals (wiring short) the BELL PTC will open.

**! For fire alarm applications, a fire alarm signalling device MUST be used.**

The Bell output is supervised. If no alarm warning device is being used connect a 1000 ohm resistor across BELL+ and BELL- to prevent the panel from displaying a trouble condition (See Section 3.4 "[\*][2]").

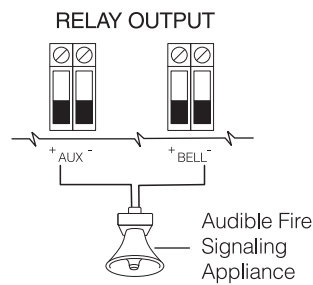

For UL installations, when a bell or siren is used for fire signaling with a pulsed cadence, it must be connected between the AUX+ and BELL- terminals. To maintain bell circuit supervision, do not connect more than one device to the BELL- terminal. A fire bell or siren used for this application must be UL Listed and have a current consumption of 400mA or less (e.g. Wheelock MT-12/24-R).

**Keybus Terminals - RED, BLK, YEL, GRN**

The Keybus is used by the panel to communicate with modules and by modules to communicate with the panel. Each module has four Keybus terminals that must be connected to the four Keybus terminals on the panel. For more information, see Section 2.3 "Keybus Operation and Wiring".

**Programmable Outputs - PGM1 and PGM2**

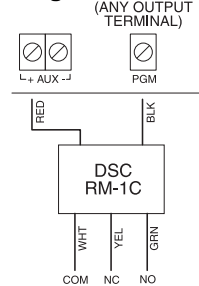

Each PGM output is an open collector switch to ground. That is, when the PGM output is activated by the panel the terminal will switch to ground.

PGM1 can sink up to 50 mA of current. PGMs can be used to activate LEDs or a small buzzer. Connect the positive side of the LED or buzzer to AUX+, the negative side to the PGM1.

PGM2 is a high current output (300mA) and operates similar to PGM1. The CON1 must remain on at all times. If more than 300 mA of current is required a relay must be used. Refer to the diagram.

**Zone Input Terminals - Z1 to Z8**

Each detection device must be connected to a zone on the control panel. It is suggested that each zone have one detection device however it is possible to wire multiple detection devices to the same zone. For zone wiring specifics, see Section 2.9 "Zone Wiring".

**Telephone Connection Terminals - TIP, RING, T-1, R-1**

If a telephone line is required for central station communication or downloading, connect an RJ-31X jack in the following manner:

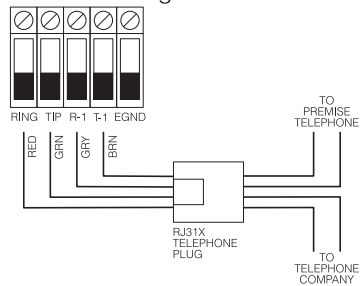

- RING - Red Wire \_\_\_\_\_ Incoming line from telephone company
- TIP - Green Wire \_\_\_\_\_ Incoming line from telephone company
- R-1 - Grey Wire \_\_\_\_\_ Outgoing line to house telephone(s)
- T-1 - Brown Wire \_\_\_\_\_ Outgoing line to house telephone(s)

Connect the PC5015 and modules that use the telephone line(s) in the following order:

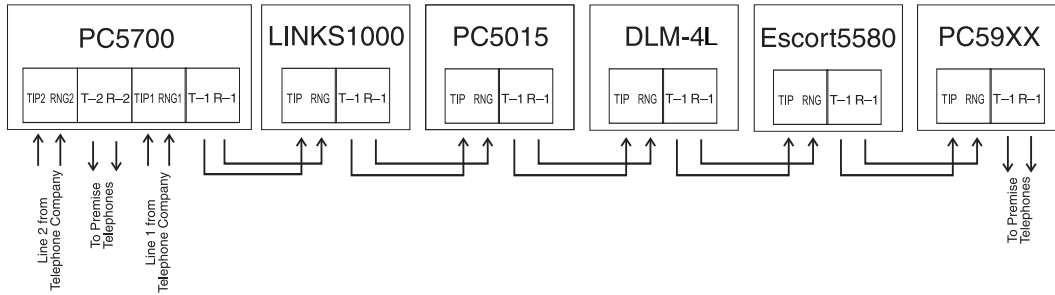

For example, if you are installing a PC5015 with a LINKS1000 and a PC5928 Intercom module, connect the incoming line to the LINKS1000, then from the LINKS1000 to the PC5015, then from the PC5015 to the PC5928 Intercom and then from the PC5928 to the house telephones

**!** *For proper operation there must be no other telephone equipment connected between the control panel and the telephone company facilities. Do not connect the alarm panel communicator to telephone lines intended for use with a FAX machine. These lines may incorporate a voice filter which disconnects the line if anything other than FAX signals are detected, resulting in incomplete transmissions.*

### 2.3 Keybus Operation and Wiring

The Keybus is used by the panel to communicate with all modules connected and by the modules to talk to the panel. The RED and BLK terminals are used to provide power while YEL and GRN are clock and data.

**!** *The 4 Keybus terminals of the panel must be connected to the 4 Keybus terminals or wires of all modules.*

The following conditions apply:

- Keybus should be run in minimum 22 gauge quad (0.5mm), two pair twist preferred
- the modules can be home run to the panel, connected in series or can be T-tapped
- any module can be connected anywhere along the Keybus, you do not need a separate Keybus wire run for keypads, zone expanders etc.
- no module can be more than 1,000'/305m (in wire length) from the panel
- shielded wire is not necessary unless wires are run in an area that may present excessive RF noise or interference

#### Example of Keybus Wiring

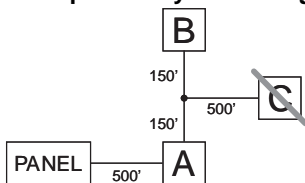

NOTE: Module (A) is wired correctly as it is within 1,000'/305m of the panel, in wire distance.

Module (B) is wired correctly as it is within 1,000'/305m of the panel, in wire distance

Module (C) is NOT wired correctly as it is further than 1,000'/305m from the panel, in wire distance.

### 2.4 Current Ratings - Modules and Accessories

In order for the Power 832 system to operate properly, the power output capabilities of the main control and expansion devices must not be exceeded. Use the data presented below to ensure that no part of the system is overloaded and cannot function properly.

#### System Outputs (all 12 Vdc)

- PC5015 VAUX: 550 mA. Subtract the listed rating for each keypad, expansion module and accessory connected to VAUX or Keybus.  
BELL: 700 mA. Continuous Rating.  
3.0 A. Short Term. Available only with stand-by battery connected.
- PC5204 VAUX: 1.0 A. Continuous Rating. Subtract for each device connected.  
3.0 A. Short Term. Available only with stand-by battery connected.
- PC5208 VAUX: 250 mA. Subtract for each device connected. Subtract the total load on this terminal from the PC5015 VAUX/Keybus output.
- PC5108 VAUX: 100 mA. Subtract for each device connected. Subtract the total load on this terminal from the PC5015 VAUX/Keybus output.

**PC5015 Device Ratings (@ 12 Vdc)**

- LCD5500 Keypad: 50 mA
- PC5532 Keypad: 45 mA
- PC5516 Keypad: 45 mA
- PC5508 Keypad: 45 mA
- LCD5500Z Keypad: 85 mA
- PC5532Z Keypad: 85 mA
- PC5516Z Keypad: 85 mA
- PC5508Z Keypad: 85 mA
- PC5108 Zone Module: 35 mA
- PC5204 Output Module: 20 mA
- PC5108L Downlook Interface: 60 mA
- PC5208 Output Module: 50 mA
- PC5132 Wireless Module: 125 mA
- Escort5580 Module: 150 mA
- PC5928 Audio Interface Module: 65 mA
- PC5921 Intercom Audio Station: 20 mA
- PC5921 EXT Door Box Audio Station: 20 mA
- PC5921 EXT/R Door Box Audio Station: 35 mA
- PC5400 Printer Module: 65 mA
- DLM-4L v1.0L: 180 mA
- PC5700 Fire Module: 150 mA

**Other Devices**

Read the manufacturer's literature carefully to determine the maximum current requirement (during activation or alarm) and use this value for loading calculations. Do not allow connected devices to exceed the system capabilities during any possible operational mode.

**2.5 Assigning Zones to Zone Expanders**

The main panel contains zones 1 to 8. Additional zone expanders may be added to increase the number of zones on the system. Each zone expander consists of two groups of 4 zones and each group must be configured to assign the specific zones to the expander. This is done by setting the jumpers located on the expander to the proper settings.

**! Before a zone expander will work properly the jumpers must be set so the panel can determine the correct zone assignment.**

The following are the jumper settings for different zone assignments:

Jumpers			System Zones Assigned
J1/J4	J2/J5	J3/J6	
ON	ON	ON	Zones disabled
OFF	ON	ON	Zones disabled
ON	OFF	ON	Zones 09 - 12
OFF	OFF	ON	Zones 13 - 16
ON	ON	OFF	Zones 17 - 20
OFF	ON	OFF	Zones 21 - 24
ON	OFF	OFF	Zones 25 - 28
OFF	OFF	OFF	Zones 29 - 32

J1, J2 and J3 set system zone assignments for expander zones 1-4

J4, J5 and J6 set system zone assignments for expander zones 5-8

The following are diagrams of the PC5108 and PC5700 zone expander modules and where the jumper switches are located. Refer to the Installation Instructions of each module for more information.

**! There are two sets of jumpers, one set for the first 4 zones of the expander and one set for the other 4 zones.**

In these two diagrams the jumpers settings shown indicate the first group of four zones of the expander will be zones 9 to 12 and the second group of 4 zones will be 13 to 16. A group of zones can be disabled if they are not required for the installation.

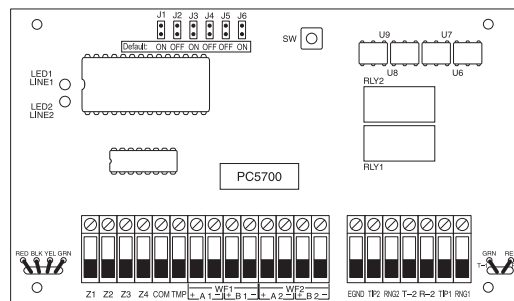
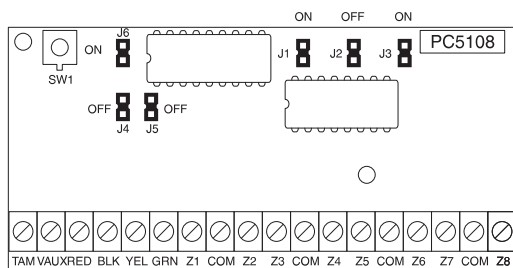

## 2.6 Keypad Assignment

There are 8 available addresses for keypads. LED keypads by default are assigned to address 1 while the LCD5500(Z) is assigned by default to address 8. Keypads can each be assigned to a different address (1 to 8) which offers two advantages. The panel can supervise the keypad connection to indicate a trouble condition if it is removed. Also keypads can be assigned to operate a specific partition or operate as a global keypad.

### 2.6.1 How to Assign Keypads

**!** *All keypad assignment must be done at each keypad on the system. When using LCD5500(Z) keypads, one keypad must remain in address 8. Do not assign more than one keypad to the same address.*

To assign a keypad to a address and select the partition it will operate, enter the following:

Step 1 — Enter Installer Programming

Step 2 — Press [000] for Keypad Programming

Step 3 — Press [0] for Partition and Address Assignment

Enter a two digit number to specify the partition and address assignment.

1st digit    Enter 0 for Global Keypad;  
                   Enter 1 for Partition 1 Keypad;  
                   Enter 2 for Partition 2 Keypad

2nd digit    Enter 1 to 8 for Address Assignment

Press the [#] key twice to exit programming. Continue this procedure at each keypad until all have been assigned to the correct address.

### 02.6.2 How to Program Function Keys

Each of the 5 Function Keys on each keypad may be programmed for different operation on each keypad.

Step 1 - Enter Installer Programming.

Step 2 - Press [000] for Keypad Programming.

Step 3 - Enter [1] to [5] to select Function Key to program.

Step 4 - Enter the 2 digit number, [00] to [25] for option.

Step 5 - Continue from Step 3 until all Function Keys are programmed.

Step 6 - Press [#] key twice to exit Installer Programming.

For a complete list of Function Key options See *Section 3.5.1 "Function Key Options"*.

## 2.7 Enable Supervision

Once all the Keybus connections have been made, supervision must be enabled so the panel can indicate a trouble if a module is removed from the system.

To enable supervision, enter the following at any keypad:

Step 1 - Press [✱] [8] [Installer Code] to enter Installer Programming.

Step 2 - Press [902] to enable supervision. The panel will automatically search for all modules on the system. Once the search (it will take about 1 minute) is complete enter the following to confirm the modules on the system.

Step 3 - Press [903] to display all modules.

Zone lights will be turned on according to what modules the panel has found on the system. The LCD keypad will allow you to scroll through the modules. Refer to the following chart:

Light [1] .....	Keypad 1 present	Light [13] .....	Zones 25 to 28 present
Light [2] .....	Keypad 2 present	Light [14] .....	Zones 29 to 32 present
Light [3] .....	Keypad 3 present	Light [15] .....	N/A (not used)
Light [4] .....	Keypad 4 present	Light [16] .....	N/A (not used)
Light [5] .....	Keypad 5 present	Light [17] .....	Module PC5132 present
Light [6] .....	Keypad 6 present	Light [18] .....	Module PC5208 present
Light [7] .....	Keypad 7 present	Light [19] .....	Module PC5204 present
Light [8] .....	Keypad 8 present	Light [20] .....	Module PC5400 present
Light [9] .....	Zones 9 to 12 present	Light [21] .....	Module PC5928 present
Light [10] .....	Zones 13 to 16 present	Light [22] .....	Alternate Communicator present
Light [11] .....	Zones 17 to 20 present	Light [23] .....	DLM-4L v1.0L present
Light [12] .....	Zones 21 to 24 present	Light [24] .....	Escort5580 module present

If a module is connected but does not show as being present, it may be due to any of the following reasons:

- it is not connected to the Keybus
- if there is a Keybus wiring problem
- if the module is more than 1,000'/305m from the panel
- if the module does not have enough power
- if the PC5132 does not have any devices added

**2.8 Removing Modules**

If a module is no longer required on the system the panel must be told to no longer supervise the module. To do this remove the module from the Keybus and perform the Enable supervision function again (See Section 2.7 "Enable Supervision"). The panel will see the module has been removed and will no longer supervise it.

**2.9 Zone Wiring**

For a complete description of the operation of all zone types, please refer to Section 5.1 ("Zone Definitions"). There are several different ways in which zones may be wired, depending on which programming options have been selected. The panel can be programmed to supervise normally closed, End of Line, or Double End of Line loops. Please refer to the following sections to study each type of individually supervised zone wiring.

**!** Any zone programmed for Fire or 24 Hour Supervisory must be wired with a single End of Line (EOL) resistor regardless of the type of zone wiring supervision selected for the panel (section [013], options [1] and [2]). See Section 5.1 "Zone Definitions." If you change the zone supervision options from DEOL to EOL or from NC to DEOL (section [013], options [1] or [2]), you should power down the system completely, and then power it back up. If you do not, the zones may not work correctly.

**2.9.1 Normally Closed (NC) Loops**

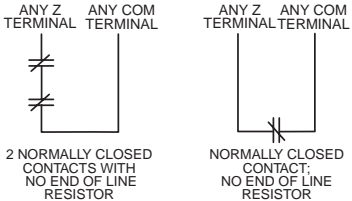

To enable normally closed loops, programming section [013], option [1] must be ON.

**!** This option should only be selected if Normally Closed (NC) devices/contacts are being used.

Normally Closed Loops ..... Section [013], Option [1]

**2.9.2 Single End Of Line (EOL) Resistors**

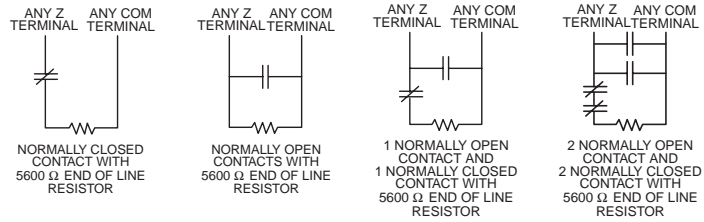

To enable panel detection of single end of line resistors, programming section [013], options [1] and [2] must be OFF.

**!** This option should be selected if either Normally Closed (NC) or Normally Open (NO) detection devices or contacts are being used.

End of Line Resistors ..... Section [013], Option [1]  
Single End of Line Resistors ..... Section [013], Option [2]

**2.9.3 Double End of Line (DEOL) Resistors**

Double End of Line resistors allow the panel to determine if the zone is in alarm, tampered or faulted. To enable panel detection of double end of line resistors, programming section [013], option [1] must be OFF and option [2] must be ON.

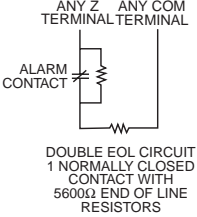

**!** If the Double EOL supervision option is enabled, all hardwire zones must be wired for Double EOL resistors, except for Fire and 24 Hour Supervisory zones. Do not wire DEOL resistors on keypad zones. Do not use DEOL resistors for Fire zones or 24 Hour Supervisory zones. Do not wire Fire zones to keypad zone terminals if the DEOL supervision option is selected. This option can only be selected if Normally Closed (NC) detection devices or contacts are being used. Only one NC contact can be connected to each zone.

The following chart shows zone status under certain conditions:

<b>Loop Resistance</b>	<b>Loop Status</b>
0Ω (shorted wire, loop shorted)	Fault
5600Ω (contact closed)	Secure
Infinite (broken wire, loop open)	Tamper
11200Ω (contact open)	Violated
.....	
End-of-Line Resistors .....	Section [013], Option [1]
Double End-of-Line Resistors .....	Section [013], Option [2]

**2.9.4 Fire Zone Wiring - 4-wire Smoke Detectors**

All zones defined as Fire (See Section 5.1 "Zone Definitions") must be wired according to the following diagram:

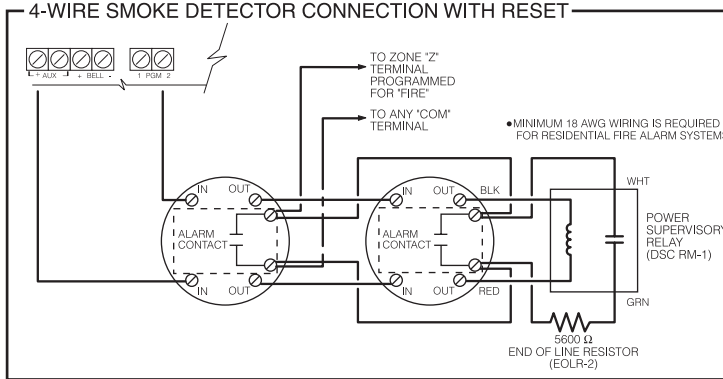

For a complete description of how fire zones operate, see Section 5.1 "Zone Definitions".

**2.9.5 Fire Zone Wiring - 2-wire Smoke Detectors**

If PGM2 has been programmed for 2-wire Smoke Detector connection (See Section 5.10 "PGM Output"), the detectors must be wired according to the following diagram:

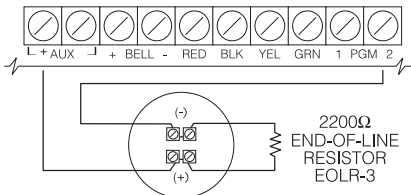

The following 2-wire smoke detectors may be used:  
ESL429AT,  
DSC MN220.

For a complete description of how fire zones operate, see Section 5.1 "Zone Definitions".

**! If PGM2 is programmed for 2 wire smoke support, Jumper CON1 on the main board must be removed.**

**2.9.6 24-Hr Auxiliary Input Wiring (PGM2)**

If PGM2 has been programmed for 24-hour operation, the zone must be wired according to the following diagram:

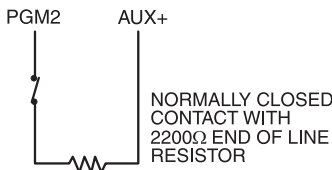

**! If PGM2 is programmed for 24-Hr Auxiliary Input support, the connector CON1 on the main board must be removed.**

**2.9.7 Keyswitch Zone Wiring**

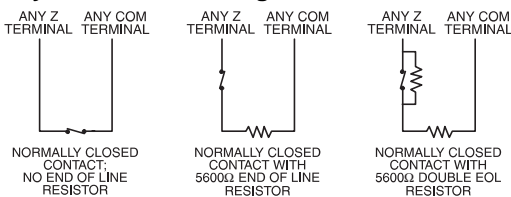

Zones may be programmed to be used as keyswitch arming zones and must be wired according to the following diagrams:

For a complete description of how keyswitch zones operate, see Section 5.1 "Zone Definitions".

**2.9.8 LINKS Supervisory (24 Hour Supervisory)**

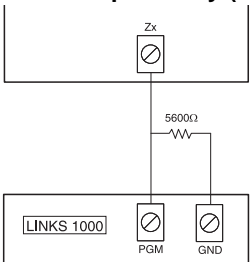

When using the LINKS1000 cellular communicator, any main board zone may be configured for LINKS Supervision. Program this zone as zone type [09], 24 Hour Supervisory in section [001].  
 With a 24 Hour Supervisory zone, if the LINKS1000 experiences a trouble, the zone will be violated, causing the panel to report the event to the central station. This type of zone *always* requires a single EOL resistor (5600Ω).  
 Wire this zone according to the diagram.

**2.9.9 LINKS Answer**

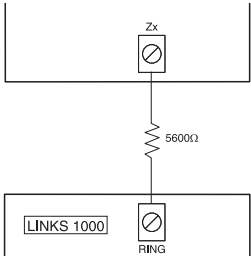

If the LINKS1000 cellular communicator is being used a zone may be configured for LINKS Answer to allow downloading to be performed in the event of phone line failure.  
 When the LINKS receives a phone call it will activate the RING terminal on the LINKS circuit board. This terminal can be used to violate a zone programmed as LINKS Answer (See Section 5.1 "Zone Definitions"), causing the panel to seize the phone line and begin communication with the downloading computer.  
 The zone programmed as LINKS Answer ALWAYS requires a single EOL resistor (5600Ω) and must be wired according to this diagram.

**! The LINKS Answer zone is only required for downloading to the panel via the LINKS. When using the LINKS, Busy Tone Detection must not be used. Keypad zones cannot be used for 24 Hour Supervisory or LINKS Answer.**

**2.10 Keypad Zones**

Keypads with zone inputs can be connected to devices such as door contacts. This saves you from running wires back to the control panel for every device.  
 To install the keypad, open the keypad plastic by removing the screw at the bottom of the unit. Locate the five terminals on the keypad circuit board. Connect the four Keybus wires from the control panel: the red wire to R, the black to B, the yellow to Y and the green to G.  
 To connect the zone, run one wire to the Z terminal and the other to B. For powered devices, use red and black to supply power to the device. Run the red wire to the R (positive) terminal and the black wire to the B (negative) terminal.  
 When using end of line supervision, connect the zone according to one of the configurations outlined in Section 2.8 "Zone Wiring." **End of line resistors must be placed on the device end of the loop, not at the keypad.**

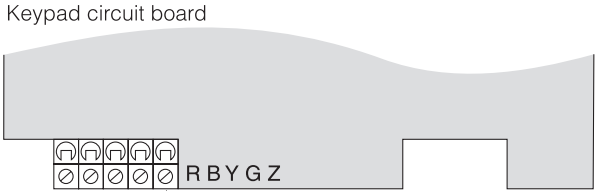

**! Keypad zones do not support DEOL resistors.**

"Z" version keypads are also indicated by a label located on the back of the keypad plastic. The label reads: "Z" version.

**Assigning Keypad Zones**

When using keypad zone inputs, each input used must be assigned a zone number in Installer's Programming. First, ensure that you have enrolled all installed keypads into the desired addresses. (See Section 2.6 "Keypad Assignment").  
 Next, enter programming section [020] to assign the zones. There are eight programming locations in this section, one for each keypad address. Enter a 2-digit zone number for each of the keypad zones. This number must be entered in the location corresponding to the keypad to which each zone is connected.

**! If a keypad zone input is assigned on zone number form 1 to 8, the corresponding zone cannot be used on the main control panel. Once the keypad zones are assigned, you must also program zone definitions and zone attributes. (See also Section 5.1.1 "Assigning Keypad Zones").**



# Keypad Commands

## S E C T I O N 3

All keypads provide complete information and control of the alarm panel. The panel can be completely programmed via any keypad on the system. LED keypads provide function indicator lights and individual zone indicator lights for the alarm circuits. The LCD keypad provides function indicator lights and word descriptions for zone status. The following sections describe how to arm, disarm and perform other keypad functions.

### 3.1 Access Codes

All 37 access codes have the ability to arm/disarm any Partition(s) it is enabled for and to activate the PGM Outputs using the [★][7] commands (See Section 3.4 "[★] Commands, [★][7]").

Additional access code attributes are also programmable. Attributes determine what abilities the code will have. To program each attribute;

1. Enter [★] [5] [Master Code] [9] to enter the attribute programming mode.
2. Enter the 2-digit number of the access code you want to edit.
3. Enter the attribute number to toggle it on or off.

The programmable attributes are as follows:

- Attribute 1: Partition 1 Operation enabled
- Attribute 2: Partition 2 Operation enabled
- Attribute 3: Zone Bypass enabled  
This attribute allows the user to bypass zones.
- Attribute 4: Escort5580 Remote Access  
This attribute allows the user to access the security system via the Escort, if installed.
- Attribute 5: Downlook Remote Trigger to Telephone Number 1  
For use with the Escort5580 and the PC5108L/DLM-4L (see the PC5108L Installation Manual for details).
- Attribute 6: Downlook Remote Trigger to Telephone Number 2  
For use with the Escort5580 and the PC5108L/DLM-4L (see the PC5108L Installation Manual for details).

**!** "Master Code" attributes cannot change. By default, each code has the attributes of the code used to program it.

The available access codes are as follows:

#### General Access Codes - Access Codes [01] to [32]

Each access code can be used to arm and disarm the system. Enable any of the access code attributes to allow access to the above-mentioned functions (access code attributes 1-6).

#### Duress Codes - Access Codes [33] and [34]

When a Duress Code is used to perform any function the panel will report a Duress Reporting Code (See Section 5.7 "Communicator - Reporting Codes").

#### Partition Master Codes - Access Codes [41] and [42]

Partition Master Codes can program additional access codes and the Duress Code for their Partition.

#### System Master Code - Access Code [40]

By default the System Master Code is enabled to operate on both Partitions and can perform any keypad function. This code can be used to program all access codes as well as the Partition Master Codes and Duress Codes.

If the **Master Code Not Changeable** option is enabled the System Master Code can only be changed using Installer Programming.

For instructions on programming access codes, see the PC5015 Instruction Manual ("Programming Access Codes").

Code Required for Bypass .....	Section [015], Option [5]
Master Code Not Changeable option .....	Section [015], Option [6]

#### Maintenance Code

The maintenance code can only be used to arm and disarm the system. It cannot be used to bypass zones or to access the Escort5580. The code can only be programmed in Installer's Programming.

Maintenance Code .....	[008]
------------------------	-------

### 3.2 Arming /Disarming

The system cannot be armed unless the 'Ready' light is on. If the 'Ready' light is not on make sure all protected doors and windows are secure and stop movement in areas covered by motion detectors. When the 'Ready' light is on enter any valid Access Code. As each digit is pressed the keypad will beep. If an incorrect code is entered the keypad will emit a steady 2 second beep to indicate the code was not correct.

If the code is correct but the 'Ready' light was not on the panel will beep six times rapidly followed by a long two second beep to indicate the system was not Ready. When the correct code is entered and the system is Ready the panel will beep six times rapidly and the 'Armed' light will turn on. Exit the premises through the designated entry/exit door. Other methods of arming are available (See Section 3.4 "[\*] Commands - [\*] [0] Quick Arm, [\*] [9] Arming Without Entry Delay" and Section 3.5 "Function Keys").

**!** *The PC5015 has a built-in feature called Audible Exit Fault. See Section 5.15 "Entry/Exit Delay Options for more information."*

To disarm the panel enter the premises through the designated entry/exit door. The keypad will emit a steady beep to warn that you must disarm the system. During the last 10 seconds of entry delay the panel will pulse the keypad beeper on and off rapidly to warn the entry delay is about to expire. Enter a valid Access Code at the keypad. If an error is made, re-enter the code correctly. When a correct code is entered the keypad will turn off the 'Armed' light and stop the keypad buzzer. If an alarm occurred while the panel was armed the 'Memory' light and the zones which caused the alarm will be flashing. Press the [#] key to return the keypad to the Ready state.

3.3 **Auto Bypass**

When the system is armed and any zone or zone(s) on the system have been programmed as Stay/Away the panel will immediately turn on the 'Bypass' light. It will then monitor all zones programmed as Delay 1 and Delay 2. If no delay type zone is violated by the end of the exit delay the panel will bypass all Stay/Away type zones. The 'Bypass' light will remain on to inform the home owner that the interior protection has been automatically bypassed by the panel. If a delay zone is violated during the exit delay, the Stay/Away zones will be active after the exit delay expires.

This is a convenience for the user that wishes to arm the panel while at home. The user does not have to bypass the interior manually.

The user can add the Stay/Away zones back into the system at any time by entering the [\*] [1] keypad command (See Section 3.4 "[\*] Commands, [\*][1] Zone Bypass").

Other methods of Stay arming are available (See Section 3.5 "Function Keys").

3.4 **[\*] Commands**

**[\*] [1] Zone Bypassing**

The [\*] [1] keypad command can be used to bypass individual zones. It can be used if the user wants to have access to an area while the Partition is armed or to bypass a defective zone (bad contact, damaged wiring) until service can be provided. A bypassed zone will not cause an alarm. Instructions on zone bypassing can be found in the PC5015 Instruction Manual ("Zone Bypassing"). When the partition is disarmed, all zones bypassed using [\*] [1] will be unbypassed, except for 24-hr zones.

If **Code Required for Bypass** is enabled an access code will be required to enter the Bypass mode. Only access codes with the Bypass attribute enabled will be able to bypass zones (See Section 3.4 "[\*] Commands, [\*] [5]").

Several features have been added to the [\*][1] zone bypassing menu:

- **Bypass Recall:** Press [99] while in the [\*][1] menu to recall the last set of bypassed zones.
- **Clear Bypasses:** Press [00] while in the [\*][1] menu to clear all bypassed zones.
- **Bypass Groups:** Two programmable bypass groups can be recalled when in the [\*][1] Bypass Menu. To program a bypass group, select the zones to be bypassed. Press [95] for Group #1, or [96] for Group #2. To recall these groups, press [\*][1] followed by [91] for Group #1 or [92] for Group #2.  
If the Code Required for Bypass option is enabled, access codes 40-42 must be used to access this feature.

**!** *For two-partition systems, Bypass Group #1 must be used on Partition 1, and Group #2 on Partition 2.*

Code required for bypass ..... Section [015], Option [5]

**[\*] [2] Trouble Display**

The panel constantly monitors itself for several different trouble conditions. If a trouble condition is present, the Trouble light will be ON and the keypad will beep twice every 10 seconds. The trouble beep can be silenced by pressing any key on any keypad. If **Bell Squawk on Trouble** is enabled (section [014], option[5]), the bell will squawk every 10 seconds when a trouble condition is present.

**To view trouble conditions from an LED keypad:**

1. Press [\*] [2].
2. The keypad will flash the Trouble light. The zone indicator lights corresponding to the present trouble conditions will be ON.

When using an LCD keypad, the trouble conditions will be listed on the display; the user must simply use the arrow (< >) keys to scroll through the list of present trouble conditions.

**!** *Troubles can be viewed while armed using the LCD keypad, provided the keypad is version 2.0 or later. Older keypads will incorrectly display "Fire Trouble". If using older LCD keypads, programming section [013], option [3] as OFF will ensure troubles are displayed correctly.*

The various troubles are described below:

**Light Trouble**

- 1 Service Required:** Press [1] to determine the specific trouble. If one of the following zone lights is on, the corresponding trouble is present:

  - Light [1] – Low Battery: Main panel backup battery charge is low (below 11.5 volts under load). Trouble is restored when the battery charges over 12.5 volts.
  - Light [2] – Bell Circuit Trouble: The bell circuit is open (see Section 5.13 “Siren”).
  - Light [3] – General System Trouble: The printer connected to the PC5400 Printer module has a fault and is off-line. There are also 5204 AUX Trouble, 5204 Output 1 Trouble, Camera Trouble and Home Automation Trouble.
  - Light [4] – General System Tamper: Tamper has been detected in a module. Entering and exiting Installer’s Programming will not reset the system tampers. All tamper conditions must be physically restored.
  - Light [5] – General System Supervisory: The panel has lost communication with a module connected to the Keybus (see Section 2.6 “Supervision”). The event buffer will log the event.
  - Lights [6] – Not used
  - Light [7] – PC5204 Low Battery: The PC5204 module has a low backup battery.
  - Light [8] - PC5204 AC Failure: The PC5204 module has lost AC power.
  
- 2 AC Failure:** AC power is no longer being supplied to the control panel. The trouble LED will flash if an AC Failure is present, if the Trouble Light Flashes if AC Fails option is programmed (section [016], option [2]). This trouble will not be displayed if the AC Trouble Displayed option is disabled (section [016], option [1]). See section 5.8 “Communicator Reporting Codes - Maintenance” for information on AC trouble reporting.
  
- 3 Telephone Line Monitoring Trouble (TLM):** There is a trouble with the telephone line (See section 5.12 “Telephone Line Monitor”). If the system has an alternate communicator, this trouble can be reported to a monitoring station by programming reporting codes in sections [349] and [350].
  
- 4 Failure to Communicate (FTC):** The communicator failed to communicate with any of the programmed telephone numbers (see section 5.5 “Communicator - Dialing”).
  
- 5 Zone Fault (including Fire Zone):** A zone on the system is experiencing trouble, meaning that a zone could not provide an alarm to the panel if required to do so (if a fire zone is open, or there is a short on a DEOL zone, or a supervisory fault on a wireless zone). When a zone fault trouble condition occurs, the keypad(s) on the system will start to beep. Press [5] while in Trouble mode to view the affected zones.

**A Fire zone trouble will be generated and displayed in the armed state. A Fire zone trouble will also restart the trouble beeps from all keypads.**
  
- 6 Zone Tamper:** A zone configured for Double End Of Line resistor supervision has a tamper condition, or the tamper switch is open on a wireless device. When a tamper condition occurs, the keypad(s) will start to beep (if the system is armed, an alarm will occur). Press [6] while in the Trouble mode to view the affected zones. If a zone is tampered or faulted, it must be fully restored to clear the trouble.
  
- 7 Device Low Battery:** A wireless device has a low battery condition. Press [7] one, two, or three times to view which devices are experiencing battery failure. An LED keypad will indicate battery failure using zone lights 1 to 8. The following will occur:

	# of beeps	Keypad displays
Press [7]	1	Zones with low batteries (LED keypad - zone lights 1 to 32)
Press [7] again	2	Handheld keypads with low batteries (LED keypad - zone lights 1 to 4)
Press [7] again	3	Wireless keys with low batteries (LED keypad - zone lights 1 to 16).
  
- 8 Loss of System Time:** When the panel is powered up, the internal clock needs to be set to the correct time. This trouble is cleared when an attempt is made to reset the clock.

**[★] [3] Alarm Memory**

The ‘Memory’ light will be on if any alarm occurred during the last armed period or if an alarm occurred while the panel was disarmed (24 hour zones). Instructions on viewing alarms in memory are located in the PC5015 Instruction Manual (“Disarming the System”).

**[★] [4] Door Chime On/Off**

If enabled the keypad will beep 5 times rapidly when a zone is tripped and restored. The panel will only do this for zones with the Door Chime attribute enabled and if the door chime feature is enabled (See Section 5.2 “Zone Attributes”). The door chime feature is explained in greater detail in the PC5015 Instruction Manual (“Door Chime Feature”).

### [★] [5] Programming Access Codes

All 37 access codes are programmed in this section. For instructions on programming access codes, see the PC5015 Instruction Manual ("Programming Access Codes").

### [★] [6] User Functions

To program user functions, perform the following:

1. Press [★] [6] [Master Code]. The keypad will flash the 'Program' light.
2. Press the number [1] to [5] for the item to be programmed.

- **[1] - Time and Date**

See the PC5015 Instruction Manual for instructions on setting the time and date ("Setting the Time and Date").

- **[2] - Auto-Arm Enable/Disable**

Enter [★] [6] [2] to enable (three keypad beeps) or disable (one long beep) the auto-arm feature.

- **[3] - Auto-Arm Schedule**

Enter [★][6][3] to change the auto-arm time for each day of the week.

Scroll to the day of the week you want to change, or enter the number of the day (1-7 for Sunday to Saturday). On an LED keypad zone lights 1-7 will represent Sunday to Saturday.

When you have selected a day, enter the auto-arm time in 24-hour format (i.e. enter a 4-digit number in [hhmm] format).

The system will return you to the day selection menu. Scroll to the next day you want to program, or to exit auto-arm programming, press [#].

---

**!** *Only LCD5500 v2.0 or greater keypads support the [★][6][3] menu option.*

---

- **[4] - System Test**

When [4] is pressed the panel will perform the following. For step-by-step instructions on performing a system test, see the PC5015 Instruction Manual ("Full System Test"):

- sound the alarm output for two seconds
- light all lights on the keypad
- sound the keypad buzzer for two seconds
- test the main panel/PC5204 battery
- send a System Test Reporting code, if programmed (*See Section 5.7 "Communicator - Reporting Codes"*).

- **[5] - Enable DLS (Downloading)**

When [5] is pressed the panel will turn on the downloading option for 6 hours. During this time the panel will answer incoming downloading calls (*See Section 5.8 "Downloading"*).

- **[6] - User Initiated Call-Up**

When [6] is pressed, the panel will initiate a call to the downloading computer.

### LCD Keypad User Functions

Additional features are available using on the LCD keypad. These features do not have numbers assigned. Use the arrow keys (< >) to scroll through the [★] [6] menu and press the [★] key to select the following commands.

- **View Event Buffer:** The 128 Event Buffer can be viewed through any LCD keypad (*See Section 5.16.1 "Viewing the Event Buffer Through the LCD Keypad"*).
- **Brightness Control:** When this option is selected the keypad will allow you to scroll through 10 different backlight level options. Use the arrow keys (<>) to scroll to the desired backlight level and press the [#] key to exit.
- **Contrast Control:** When this option is selected the keypad will allow you to scroll through 10 different contrast level options. Use the arrow keys (<>) to scroll to the desired contrast level and press the [#] key to exit.
- **Keypad Buzzer Control:** When this option is selected the keypad will allow you to scroll through 21 different keypad sounder tone options. Use the arrow keys (<>) to scroll to the desired keypad beeper level and press the [#] key to exit. This function can be achieved on LED keypads by holding the [★] key.

### [★] [7] Command Output Functions

There are four output functions available to the user. Entering [★] [7] [1-4] [Access Code, if required] will activate any output programmed for options [19]-[22] (respectively). Each function can be performed when the system is either armed or disarmed.

For more information regarding these output types, see Section 5.10 "PGM Output Options."

### [★] [8] Installer Programming

Enter [★][8] followed by the Installer Code to enter Installer Programming (*See Section 4.0 "How to Program"*).

### [★] [9] Arming Without Entry Delay

When a Partition is armed with the [★][9] command the panel will remove the entry delay from the partition. After the exit delay, Delay 1 and Delay 2 type zones will be instant and Stay/Away zones will remain bypassed. (*See Section 5.1 "Zone Definitions"*).

For more information regarding this feature, see the PC5015 Instruction Manual (“Alternate Arming Methods – Arming Without Entry Delay”).

The entry delay can be activated/deactivated at any time while the system is armed by pressing [★][9].

**[★] [0] Quick Arm**

If the Quick Arm Enable option is enabled the panel can be armed by entering [★][0]. This is a useful method of arming a Partition when someone without a access code will be required to arm a Partition.

**! The Quick Arm feature must be enabled in order for the Stay/Away function keys to operate as intended. If the feature is not enabled, the user will be required to enter their access code after pressing the Stay or Away function key in order to arm the system in the stay or away mode.**

**[★] [0] Quick Exit**

Quick Exit will allow someone to leave an armed premise through a Delay type zone without having to disarm and rearm the system.

When [★][0] is entered, if the Quick Exit Enabled option is enabled, the panel will provide a two minute window to exit. During this time the panel will ignore the first activation of a Delay type zone. When the Delay zone is secured the panel will end the two minute time period.

If a second Delay zone is tripped, or if the zone is not restored after two minutes, the panel will start entry delay.

**! If Quick Exit is used on a partitioned system, Keypad Blanking and Access Code Required to Remove Blanking should be enabled.**

Quick Arm Enable.....	Section [015], Option [4]
Quick Exit Enable .....	Section [015], Option [3]

**3.5 Function Keys**

There are five function keys on the PC5015 keypads labelled Stay, Away, Chime, Reset and Exit. The operation of these keys is described below. The function is activated by pressing and holding the key for 2 seconds.

**“Stay” - Stay Arm**

Arms the partition to which the keypad is assigned. All Stay/Away type zones will be automatically bypassed. Delay type zones will provide entry and exit delay. The Quick Arm feature must be enabled for this key to function (*Section [015], Option [4]*). If Quick Arming is not enabled, the user must enter their access code after pressing the function key in order to arm the system in the Stay mode.

**“Away” - Away Arm**

Arms the partition to which the keypad is assigned. All Stay/Away type zones will be active at the end of the exit delay. Delay type zones will provide entry and exit delay. The Quick Arm feature must be enabled for this key to function (*Section [015], option [4]*). If Quick Arming is not enabled, the user must enter their access code after pressing the function key in order to arm the system in the Away mode.

**“Chime” - Door Chime On/Off**

Pressing the key will toggle the Door Chime feature ON or OFF. One solid beep means the feature has been disabled, three short beeps means it has been enabled.

**“Reset” - Reset Smoke Detectors**

Pressing this key will cause the panel to activate for 5 seconds any output programmed as Sensor Reset. (*See Section 3.4 “[★] Commands, [★][7][2]”*).

**“Exit” - Activate Quick Exit**

Pressing this key will cause the panel to activate the Quick Exit feature (*See Section 3.4 “[★] Commands, [★][0]”*).

**3.5.1 Function Key Options**

The following is a list of Function Key options:

**[00] - Null Key**

The key is not used and will perform no function when pressed.

**[01] - Select Partition 1**

Provides an easy way to select Partition 1 operation from a Partition 2 keypad. This is the same as pressing and holding the [#] key then pressing and holding the [1] key to select Partition 1 from a Partition 2 keypad (*See Section 3.6 “Global and Partition Keypad Operation”*).

**[02] - Select Partition 2**

Provides an easy way to select Partition 2 operation from a Partition 1 keypad. This is the same as pressing and holding the [#] key then pressing and holding the [2] key to select Partition 2 from a Partition 1 keypad (*See Section 3.6 “Global and Partition Keypad Operation”*).

**[03] - Stay Arm**

Same as described in Function Keys - Section 3.5.

**[04] - Away Arm**

Same as described in Function Keys - Section 3.5.

**[05] - [\*]+[9] No-Entry Delay Arm**

After this function key is pressed the user must enter a valid access code. The Partition will arm and remove entry delay from the partition when the exit delay expires (See Section 3.4 "[\*] Commands, [\*] [9] Arming without entry delay").

**[06] - [\*]+[4] Door Chime On/Off**

This function key provides the user a simple method for turning the Door Chime feature on and off (See Section 3.4 "[\*] Commands, [\*] [4] Door chime on/off").

**[07] - [\*]+[6]...[4] System Test**

This function key provides the user with a simple method for testing the system (See Section 3.4 "[\*] Commands, [\*] [6] User functions"). A valid Master Code is required to perform this command.

**[08] - [\*]+[1] Bypass Mode**

This function key provides the user with a simple method for entering the Bypass Mode. If a access code is required it must be entered before bypassing can be performed (See Section 3.4 "[\*] Commands, [\*] [1] Zone Bypass").

**[09] - [\*]+[2] Trouble Display**

This function key provides the user with a simple method for entering the Trouble Display Mode (See Section 3.4 "[\*] Commands, [\*]+[2] Trouble display").

**[10] - [\*]+[3] Alarm Memory**

This function key provides the user with a simple method for entering the Alarm Memory Display Mode (See Section 3.4 "[\*] Commands, [\*] [3] Alarm memory").

**[11] - [\*]+[5] Programming Access Codes**

This function key provides the user with a simple method for programming access codes. After this key is pressed a valid System Master or Partition Master will have to be entered before the panel will allow programming to be performed (See Section 3.4 "[\*] Commands, [\*] [5] Programming Access Codes").

**[12] - [\*]+[6] User Functions**

This function key provides the user with a simple method for programming User Functions. After this key is pressed a valid System Master or Partition Master must be entered before the panel will allow User Functions to be performed (See Section 3.4 "[\*] Commands, [\*] [6] User functions").

**[13] - [\*]+[7]+[1] Command Output Option 1**

This function key provides the user with a simple method for activating a PGM Output programmed as Command Output Option 1 (See Section 5.10 "PGM Outputs"). By default, after this key is pressed a valid access code must be entered (See Section 3.4 "[\*] Commands, [\*] [7] Command output functions").

**[14] - [\*]+[7]+[2] Smoke Detector Reset**

This function key provides the user with a simple method for activating a PGM output programmed as either option [03] Sensor Reset, [04] 2-wire Smoke Support or [20] Command Output option 2.

**[15] - General Voice Prompt Help**

This feature can only be programmed if both the Escort5580 and the PC5928 Audio Matrix module are being used.

When the function key is pressed, the intercoms will perform a Help page. The user must then press the Page/Answer button on any intercom station to begin the help session with the Escort.

For more information, please refer to the PC5928 Installation Manual.

**[16] - [\*]+[0] Quick Exit**

Same as described in Function Keys - Section 3.5.

**[17] - [\*]+[1] Reactivate Stay/Away Zones**

This function key provides the user with a simple method for adding Stay/Away zones back into the system (see Section 3.4 "[\*] Commands, [\*] [1] Reactivate Stay/Away zones").

**[18] Identified Voice Prompt Help**

This feature can only be programmed if both the Escort5580 and the PC5928 Audio Matrix module are being used.

When the function key is pressed, the Escort will begin a help session from the intercom station programmed as closest to the keypad. In order for this option to function, you must program PC5928 Section [802], subsection [14] "Keypad Port Assignments." For more information, please refer to the PC5928 Installation Manual.

**Note: This function key cannot be programmed for PC55XXZ LED keypads with software version 1.0.**

**[19] - [\*]+[7]+[3] Command Output 3**

**[21] - [\*]+[7]+[4] Command Output 4**

Function Keys [19] and [21] provide the user with a simple method of activating an output programmed as Command Output Option 3 or 4.

**[22] - Active Camera Monitor Selection**

This function key is for use with the PC5108L Downlook Interface/Camera Monitor Module. For instructions on the function key use, see the PC5108L Installation Manual.

**[23] - Bypass Recall**

Pressing this function key will recall the last group of bypassed zones. The function key will follow the Code Required for Bypass option. If the option is enabled, a valid access code with the Bypass attribute enabled must be entered after the function key is pressed. For instructions on zone bypassing, see the PC5015 Instruction Manual.

**[24] - Recall Bypass Group #1**

This function key will recall zones in Bypass Group #1. This group is programmed by the user in the [\*][1] Bypass menu. The function key will follow the Code Required for Bypass option. If the option is enabled, a valid access code with the Bypass attribute enabled must be entered after the function key is pressed. For instructions on zone bypassing and programming Bypass Groups, see the PC5015 Instruction Manual.

**[25] - Recall Bypass Group #2**

This function key operates similar to function key [24] but will recall zones in Bypass Group #2. For instructions on zone bypassing and programming Bypass Groups, see the PC5015 Instruction Manual.

3.6 Global and Partition Keypad Operation

A global keypad will not display any information (the trouble LED will light if a trouble condition is present) until a partition is selected. To select a partition the user must press and hold the [1] key for Partition 1 or the [2] key for Partition 2 for two seconds. The keypad will then display the status of the selected partition and allow normal operation.

A Partition keypad will display the status of the Partition for which it has been programmed. A user with access to both partitions may temporarily assign the keypad to the other partition to gain access. To do this the user must first press and hold the [#] key for two seconds. The keypad will go blank. The user must then press and hold the [1] key for Partition 1 or the [2] key for Partition 2 for two seconds. The keypad will then display the status of the selected partition and allow normal access.

3.7 Features Available for the LCD5500Z

These features are only available for LCD5500Z keypads with zone inputs:

**Automatic Scrolling of Alarms in Memory**

The LCD5500Z keypad allows automatic scrolling through alarms in memory while the keypad is idle. This feature, if enabled, will override the clock display. This option can be programmed in LCD programming section [66], option [4].

**24 Hour Time Display Option**

The LCD5500Z can be programmed to display time using a 24- hour clock, instead of a 12-hour, a.m./p.m. clock. This option can be programmed in LCD programming section [66], option [3].

**Keypad Zones**

See section 2.10 "Keypad Zones".

**Viewing Troubles While Armed**

See section 3.4 "[\*][2] Trouble Display" for information on how to view troubles.

**Backlighting Boost (available for all zone input keypads)**

The LCD5500Z and PC55XXZ zone input keypads will provide extra number pad lighting when any key is pressed. The backlighting boost will last for an additional 30 seconds after the last keypress.

Prompts for the following features are only supported by LCD5500(Z) v2.X:

- Downlook Support (DLM-4L/PC5108L): Active Camera Monitor Selection, Remote Trigger
- Auto Arm features: Late to Close, Auto Arm Postpone/Cancel, Auto Arm by day
- Bypass groups

# How to Program

## S E C T I O N 4

The following section of the manual describes how to enter Installer Programming and how to program the various sections.

**!** *It is extremely important that you read the following section of the manual to completely understand how to program the panel.*

### 4.1 How to Enter Installer Programming

Installer Programming is used to program all communicator and panel options. The **Installer Code** is [5015] at default but should be changed to prevent unauthorized access to programming.

**!** *Once the Installer's Mode is exited, the system will reset. This will take 15 seconds. Do not attempt to perform any system function during this reset period. In addition, all outputs will return to their normal, deactivated state (or activated if inverted).*

#### LED Keypad

**Step 1** From any keypad enter [\*][8][Installer Code].

- The 'Program' light will flash to indicate you are in programming
- The 'Armed' light will turn on to indicate the panel is waiting for the 3 digit Section number to program

**Step 2** Enter the 3 digit Section number you want to program.

- The Armed light will turn off
- The Ready light will turn on to indicate the panel is ready for the information for the selected Section

**!** *If the 3 digit section number entered is not valid or the module that pertains to the Section is not present, the keypad will sound a 2 second beep or error tone.*

#### LCD Keypad

**Step 1** From any keypad enter [\*][8][Installer Code].

The Keypad will display 'Enter Section' followed by three dashes.

**Step 2** Enter the 3 digit Section number you want to program.

The keypad will now display information for the section entered.

.....  
Installer Code..... Section [006]  
.....

### 4.2 Programming Decimal Data

When the Ready light is ON the panel is waiting for the information to be programmed for the selected Section. Enter the information written in the boxes for the Section found in the Programming Worksheets. If a digit is entered for each program box in a Section the panel will automatically exit from the Section. It will turn OFF the Ready light and turn the Armed light back ON.

You can also press the [#] key to exit a Section before entering data for every box. This is handy if you only need to change the first few program boxes. All other locations in the Section will remain unchanged. If the [#] key is pressed the panel will turn OFF the Ready light, turn ON the Armed light and exit you from the Section.

### 4.3 Programming HEX Data

On occasion, hexadecimal (HEX) digits may be required. To program a HEX digit press the [\*] key. The panel will enter HEX programming and Ready light will begin to flash.

The following table indicates which number should be pressed to enter the corresponding HEX digit:

1 = A    2 = B    3 = C    4 = D    5 = E    6 = F

After the correct HEX digit is entered the Ready light will continue to flash. If another HEX digit is required press the corresponding number. If a decimal digit is required press the [\*] key again. The Ready light will turn on solid and the panel will return to regular decimal programming.

**!** *It is important to watch the Ready light. If the light is flashing any number you enter will be programmed as the HEX equivalent.*

Example: To enter 'C1' for a closing by user 1, you would enter [\*] [3] [\*], [1]

[\*] to enter Hexadecimal mode (Ready light flashes)

[3] to enter C

[\*] to return to decimal mode (Ready light is solid)



[1] to enter digit 1

If you enter information into a section and make a mistake, press the [#] key to exit the section. Select that section again and re-enter the information correctly.

If you are using a pulse communications format, a decimal zero [0] does not transmit. Programming a zero [0] tells the panel not to send any pulses for that digit. Decimal zero [0] is a filler digit. To make a zero [0] transmit, it must be programmed as a Hexadecimal 'A'.

Example: for the three digit account number '403', you would enter [4], [★] [1] [★] [3], [0].

[4] to enter the digit 4

[★] to enter Hexadecimal mode (Ready light flashes)

[1] to enter A

[★] to return to decimal mode (Ready light is solid)

[3] to enter the digit 3

[0] to enter the digit 0 as a filler digit.

#### 4.4 Programming Toggle Option Sections

Some Sections contain several toggle options. The panel will use zone lights 1 through 8 to indicate if the different options are enabled or disabled. Refer to the Programming Worksheets to determine what each option represents and whether the light should be ON or OFF for your application.

Press the number corresponding to the option to toggle the light ON or OFF.

Once all the toggle options have been selected correctly press the [#] key to exit the Section and save the changes. The panel will turn off the Ready light and turn on the Armed light.

#### 4.5 Viewing Programming

##### 4.5.1 LED Keypads

Any program Section can be viewed through the keypad. When a Section is entered the keypad will immediately display the first digit of information programmed in that Section.

The keypad displays the information using a binary format where:

Zone Light 1 = 1

Zone Light 2 = 2

Zone Light 3 = 4

Zone Light 4 = 8

Add up the values for the zone lights to determine the number displayed (for example, no zone lights = 0, all 4 zone lights = 15 HEX 'F').

Press any of the Emergency Keys (Fire, Auxiliary or Panic) to advance to the next digit. When all the digits in a Section have been viewed the panel will exit the Section, turn off the Ready Light, turn on the Armed light and wait for the next three digit Section number to be entered. If the [#] key is pressed the panel will also exit the Section.

##### 4.5.2 LCD Keypad

Any program section can be viewed through the keypad. Depending on the section entered, the LCD will display the information differently as below:

Sections Entered	LCD Display
Phone number .....	Entire phone number
Partition identifier code .....	Entire partition identifier code
Toggle option .....	Entire section (all options)
Reporting code .....	Each 2-digit reporting code at a time

Use the arrow keys (<>) to scroll through the data being displayed.

Scroll past the end of the data displayed or press the [#] key to exit the Section.

# Program Descriptions

## S E C T I O N 5

The following section explains all the programmable features including how the feature operates, options that pertain to the feature and a summary of program locations that require programming.

### 5.1 Zone Definitions

These sections will allow you to select how each of the 32 zones will operate. Each zone requires a 2 digit entry.

---

**!** *In addition to selecting how each zone will operate, attributes may be programmed by zone (See Section 5.2 "Zone Attributes").*

---

- [00] **Null Zone** The zone will not operate in any way. Zones that are not used should be programmed as Null zones.
- [01] **Delay 1 Zone** If this zone is violated when the panel is armed it will provide entry delay. The keypad buzzer will sound to warn the user that the system must be disarmed. If the panel is not disarmed before the entry delay expires an alarm will be generated. Typically this type of zone will be used for the front door, back door or any other entry/exit point. Refer to Section [005], "System Times", to program the Delay 1 zone entry delay time.
- [02] **Delay 2 Zone** This zone type operates the same as the Delay 1 zone option but can provide a different entry delay. Typically this zone will be used for a garage door. Refer to Section [005], "System Times", to program the Delay 2 zone entry delay.
- [03] **Instant Zone** If this zone type is violated when the panel is armed it will cause an instant alarm. Typically this zone is used for windows, patio doors or other perimeter type zones.
- [04] **Interior Zone** If this type of zone is violated when the panel is armed it will provide entry if a delay type zone was violated first. Otherwise it will cause an instant alarm. Typically this zone is used for interior protection devices, such as motion detectors.
- [05] **Interior Stay/Away Zone** This zone type works the same as the Interior zone type with one exception. The zone will be automatically bypassed under the following conditions:
- the panel is armed in the Stay Mode (See Section 3.5 "Function Keys")
  - the panel is armed without entry delay (See Section 3.4 "[\*] Commands, [\*] [9]")
  - the panel is armed with an access code and during the exit delay a Delay type zone is NOT tripped
- The automatic bypass avoids having the user manually bypass interior type zones when arming at home. If automatically bypassed, the user can reactivate the zones by entering the [\*][1] command (See Section 3.4 "[\*] Commands, [\*][1] Zone Bypass"). Typically this zone is used for interior protection devices, such as motion detectors. Stay/Away zones should not be programmed as global zones.
- [06] **Delay Stay/Away Zone** This zone type will operate the same as the Interior Stay/Away zone type except that it will always provide entry delay. Typically this zone is used for interior protection devices, such as motion detectors and will help prevent false alarms since it will always provide the user the entry delay time to turn off the panel. Stay/Away zones should not be programmed as global zones.
- [07] **Delayed 24 Hour Fire Zone** If this zone is violated the alarm output will immediately activate but the communicator will be delayed for 30 seconds. If during the 30 second delay the user presses any key on any keypad the alarm output and communicator will be delayed an additional 90 seconds, providing the user time to correct the problem. If after the 90 second delay the zone is still violated the process will begin again: the alarm output will be activated but the communication will be delayed 30 seconds. If the user does not press a key, after 30 seconds the alarm output will latch and the panel will communicate. The alarm will sound for the Bell Cutoff time programmed in Section [005], or can be programmed to sound until a valid code is entered, Section [014], Option [8].

---

**!** *PGM outputs programmed as [10] "Latched System Event" will only activate after the Delayed 24 Hour Fire zone has latched.  
If a second Fire type zone is violated or the Fire keys are pressed during the delay time the panel will latch the alarm output and communicate immediately.  
Do not wire Fire zones on keypad zone terminals if the DEOL supervision option is enabled for the panel (section [013], option [2]).  
Do not program fire zones for Downlook operation.*

---

If a delayed Fire zone is violated it will be displayed on all keypads and can be delayed at any keypad. Typically this zone is used for latching smoke detectors.

- [08] **Standard 24 Hour Fire Zone** When violated the panel will immediately latch the alarm output and communicate to central station. The alarm will sound for the Bell Cutoff time programmed in Section [005], or can be programmed to sound until a valid code is entered, Section [014], Option [8]. If a Fire zone is violated it will be displayed on all keypads. Typically this zone is used for pull stations.

---

**!** *Do not wire Fire zones on keypad zone terminals if the DEOL supervision option is enabled for the panel (section [013], option [2]).  
Do not program fire zones for Downlook operation.*

---

- [09] **24 Hour Supervisory Zone** If this zone is violated, whether armed or disarmed, the panel will report to the central station, and log the zone fault. This zone gives a silent alarm by default.  
**! Do not wire 24-Hour Supervisory zones on keypad zone terminals.**
- [10] **24 Hour Supervisory Buzzer Zone** Whether armed or disarmed, when this zone type is violated the panel will immediately latch the keypad buzzer until a valid access code is entered and will communicate immediately to the central station.
- [11] **24 Hour Burglary Zone** If this zone is violated, whether armed or disarmed, the panel will immediately latch the alarm output and communicate to the central station. The alarm will sound for the Bell Cutoff time programmed in *Section [005] "System Times"* or until a valid access code is entered.
- [12]-[20] The following zone definitions operate similar to the 24 Hour Burglary except for System Event output type and SIA identifier:
- |                                 |                                    |                                     |
|---------------------------------|------------------------------------|-------------------------------------|
| [12] <b>24 Hour Holdup Zone</b> | [15] <b>24 Hour Medical Zone</b>   | [18] <b>For future use</b>          |
| [13] <b>24 Hour Gas Zone</b>    | [16] <b>24 Hour Panic Zone</b>     | [19] <b>24 Hour Water Flow Zone</b> |
| [14] <b>24 Hour Heat Zone</b>   | [17] <b>24 Hour Emergency Zone</b> | [20] <b>24 Hour Freezer Zone</b>    |
- NOTES: [12] 24 Hour Holdup zones give a silent alarm by default. Use fire zones for sprinklers.**
- [21] **24 Hour Latching Tamper** If this zone is violated the installer must enter Installer Programming before the panel will allow either Partition to be armed. The bell output will also activate for the programmed time and the panel will communicate the alarm.
- [22] **Momentary Keyswitch Arm Zone** Momentary violation of this zone will alternately arm/disarm the Partition the zone is assigned to. This zone type should not be programmed as global.
- [23] **Maintained Keyswitch Arm Zone** When this zone is violated, the partition it is assigned to will arm. When this zone is secured, the partition will disarm. This zone should not be programmed as global zone.  
**! Do not program wireless zones as [21] or [22] Keyswitch or as [24] LINKS Answer zones.**
- [24] **LINKS Answer Zone** If the LINKS1000 cellular communicator is being used it is possible to perform downloading through the unit if the phone line is disconnected. If this is required connect the RING terminal of the LINKS1000 to this zone. Refer to the LINKS1000 Installation sheet for more information.  
**! Do not wire LINKS Answer zones on keypad zone terminals.**
- [25] **Interior Delay Zone** When the system is fully armed (ie. away armed), this zone will, as is standard, follow the exit delay. It will also follow the entrance delay, provided that a delay zone is first tripped. If the delay zone is not tripped first, a zone defined as "Interior Delay" will go into alarm instantly. When the system is at-home or stay armed this zone will be active, but when it is tripped, it will initiate the entrance delay.
- [26] **24 Hour Non-Alarm** This zone type will be active at all times but will not cause an alarm.  
**! This zone type shall not be used for Downlook-initiating zones (DLM-4L v1.0L) .**
- [87] **Delayed 24 Hour Fire (Wireless)** This zone type operates the same as [07] Delayed 24 Hour Fire Zone and must be used if the smoke detector is wireless.
- [88] **Standard 24 Hour Fire (Wireless)** This zone type operates the same as [08] Standard 24 Hour Fire Zone and must be used if the smoke detector is wireless.

**5.1.1 Assigning Keypad Zones**

Each keypad has a zone input to which a device—such as a door contact—can be connected. (See Section 2.12 "Keypad Zones" for wiring information.)

Once the keypad zones are installed, assign the zone in programming section [020] **Keypad Zone Assignments**.

Enter the 2 digit zone designated for each keypad (address) from 01-32.

•••••  
 Keypad Zone Assignments ..... [020]  
 •••••

**5.2 Zone Attributes**

Each zone will operate according to the Zone Definition selected for it (*See Section 5.1 "Zone Definitions"*). Additional zone attributes can be programmed to customize the operation of a zone for a specific application. The following attributes are programmable by zone:

**! Attributes for Fire Zones should not be changed from default.**

**Audible/Silent** Determines whether the zone will activate the alarm output or will be silent.

**Pulsed/Steady** Determines if the alarm output will be steady or pulse on for 1 second and off for one second.

**Activate Chime** Determines if the zone will activate the chime feature (*See Section 3.4 "[\*] Commands, [\*] [4] Door Chime ON/OFF"*).

**Bypass Enable** Determines if the zone can be manually bypassed (*See Section 3.4 "[\*] Commands, [\*] [1] - Zone Bypass"*).

**Force Arm Enable** Determines if the system can be armed with the zone violated. At the end of exit delay, if this type of zone is violated, it will be ignored by the panel. Once the zone is secured it will be added back into the system.

This zone attribute is useful for a garage door. The customer can arm the system with the garage door open. Later when the customer closes the door it becomes part of the system.

**NOTE: 24-hour zones must not have Force Arm enabled.**

**Swinger Shutdown Enable** Determines if the panel will shut down the communicator for the zone after the swinger limit is reached (See Section 5.17 "Swinger Shutdown").

**Transmission (TX) Delay Enable** Determines if the panel will delay communicating the alarm reporting code to the central station (See Section 5.7.1 "Transmission Delay").

**! Do not use the transmission delay on Downlook zones.**

**Wireless Zone** Determines if the zone is a wireless zone or a hardwired zone. Allows the panel to generate low battery trouble and zone supervisories.

**! The wireless zone attribute must be set enabled for all enrolled wireless zones.**

Zones 1 to 32 Attributes .....	Section [101] - [132]
Audible/Silent Alarm .....	Section [101] - [132], Option [1]
Pulsed/Steady Alarm .....	Section [101] - [132], Option [2]
Activate Chime .....	Section [101] - [132], Option [3]
Bypass Enable .....	Section [101] - [132], Option [4]
Force Arm Enable .....	Section [101] - [132], Option [5]
Swinger Shutdown Enable .....	Section [101] - [132], Option [6]
Transmission Delay Enable .....	Section [101] - [132], Option [7]
Wireless Zone .....	Section [101] - [132], Option [8]

### 5.3 Communicator - Dialing

If the **Communicator Disable** option is selected the panel will not attempt to call central station. If enabled the panel will attempt to call central station when an event occurs that has a valid reporting code programmed (See Section 5.7 "Communicator - Reporting Code"). You must also program a valid telephone number.

**Communicator Call Direction** Options are used to select which phone number the panel will dial when an event occurs.

If **DTMF Dialing** is enabled the panel will dial using DTMF (touch tone). If **Switch to Pulse Dial** is enabled the panel will switch to pulse dialing on the 5th attempt to call the central station. If disabled the panel will always dial DTMF.

If **DTMF Dialing** is disabled the panel will always pulse dial.

The **Post Dial Wait for Handshake** determines the amount of time the panel will wait for a valid handshake from the receiver. If the panel does not hear the handshake it will consider the call a failed attempt, hang up and try again.

The **Maximum Dialing Attempts** determines the maximum number of attempts the panel will make to send a signal to the central station before indicating a Failure to Communicate (FTC) trouble condition. The 3rd Phone Number can be used to back up the 1st in this situation (See Section 5.4 "Communicator - Phone Numbers").

Pulse Dialing .....	Section [380], Option [3]
Switch to Pulse Dial .....	Section [380], Option [4]
Post Dial Wait for Handshake .....	Section [161]
Maximum Dialing Attempts .....	Section [160]
Communicator Disable .....	Section [380], Option [1]
Communicator Call Direction Options .....	Section [361] to [368]

### 5.4 Communicator - Phone Numbers

The panel can call 3 different phone numbers for communication to central station. The **1st Phone Number** is the primary number, the **2nd Phone Number** is the secondary number and the **3rd Phone Number** will back up the 1st phone number if enabled.

**! The 3rd Phone Number will NOT back up the 2nd Phone Number.**

If **Alternate Dial** is enabled the panel will alternate between the 1st and 3rd phone numbers when attempting to call the central station. If disabled the panel will only attempt to call the 3rd phone number after failing to communicate on the 1st phone number.

**! For Alternate Dial to work properly the 3rd Phone Number must be enabled.**

Phone numbers can be up to 32 digits which will allow you to add special digits if required. To program the phone number enter numbers 0 through 9 as required. The following is a list of HEX digits which can also be programmed and the function they perform:

- HEX (B) - simulates the [\*] key on a touch tone phone
- HEX (C) - simulates the [#] key on a touch tone phone
- HEX (D) - forces the panel to search for dial tone
- HEX (E) - forces the panel to pause for 2 seconds
- HEX (F) - end of phone number marker

.....

1st Phone Number .....	Section [301]
2nd Phone Number .....	Section [302]
3rd Phone Number .....	Section [303]
3rd Phone Number Enable .....	Section [380], Option [5]
Alternate Dial .....	Section [380], Option [6]

.....

5.5 Communicator - Account Numbers

There are two **Partition Identifier Codes** (or Account Numbers) programmable, one for each Partition. The Account Number is used by central station to determine which panel is calling.

If the panel is programmed as two Partitions both Account Numbers must be programmed. The panel will report to the central station by Partition. For example, if an alarm occurs on a zone assigned to Partition 1 the panel will report using Partition 1 Account Number.

.....

Partition 1 Identifier Code .....	Section [310]
Partition 2 Identifier Code .....	Section [311]

.....

5.6 Communicator - Reporting Formats

Each central station phone number of the panel can be programmed to report using any one of the 5 formats available. The following formats are supported: Pulse (10 and 20 BPS), Contact ID, SIA, Residential Dial and a Pager format. The following is a description of each:

5.6.1 Pulse Formats

Depending on the pulse format selected the panel will communicate using the following:

- 3/1, 3/2, 4/1 or 4/2
- 1400 or 2300 Hz handshake
- 10 or 20 bits per second
- non-extended

**Additional Notes on Pulse Formats**

1. The digit '0' will send no pulses and is used as a filler.
2. When programming account numbers enter four digits.
3. When programming a three digit account number the fourth digit must be programmed as a plain '0' which will act as a filler digit.
4. If an account number has a '0' in it, substitute a HEX digit 'A' for the '0'. Examples:
  - 3 digit account number [123] - program [1230]
  - 3 digit account number [502] - program [5A20]
  - 4 digit account number [4079] - program [4A79]
5. When programming reporting codes two digits must be entered. If one digit reporting codes are to be used the second digit must be programmed as a '0'. If a '0' is to be transmitted substitute a HEX digit 'A' for the '0'. Examples:
  - 1 digit reporting code [3] - program [30]
  - 2 digit reporting code [30] - program [3A]
6. To prevent the panel from reporting an event program the reporting code for the event as [00] or [FF].

---

**! This communication format cannot be selected if Downlook is required.**

---

.....

Communicator Format Options .....	Section [360]
-----------------------------------	---------------

.....

5.6.2 Contact ID

Contact ID is a specialized format that will communicate information using tones rather than pulses. This format allows more information to be sent faster than other formats. For example, in addition to reporting an alarm in zone one, the Contact ID format will also report the type of alarm, such as an Entry/Exit alarm. If the **Contact ID uses Programmed Reporting Codes** option is enabled, a two digit number from Appendix A must be entered in programming sections [320] to [353] for each event to be transmitted. The two digit number determines the type of alarm. The panel will automatically generate all other information, including the zone number.

If the **Contact ID uses Automatic Reporting Codes** option is enabled, the panel will operate as follows:

1. If an event's reporting code is programmed as [00], the panel will not attempt to call the central station.
2. If the reporting code for an event is programmed as anything from [01] to [FF], the panel will automatically generate the zone or access code number. See Appendix A for a list of the codes which will be transmitted.

---

**! If the Automatic Contact ID option is selected, the panel will automatically generate all zone and access code numbers, eliminating the need to program these items.**

---

If the **Contact ID uses Programmed Reporting Codes** option is enabled, the panel will operate as follows:

1. If an event's reporting code is programmed as [00] or [FF], the panel will not attempt to call central station.
2. If the reporting code for an event is programmed as anything from [01] to [FE], the panel will send the programmed reporting code.

**Additional Notes on Contact ID**

1. Account numbers must be four digits.
2. All reporting codes must be two digits.
3. Substitute the HEX digit 'A' for the '0'.
4. To prevent the panel from reporting an event, the reporting code should be programmed as [00]. Please refer to Appendix A: "Reporting Codes" for a list of Contact ID Identifiers.

.....  
 Contact ID Uses Programmed/Automatic Codes... [381]: [7]  
 .....

**5.6.3 SIA (Level 2)**

SIA is a specialized format that will communicate information quickly using frequency shift keying (FSK) rather than pulses. The SIA format will automatically generate the type of signal being transmitted, such as Burglary, Fire, Panic etc. The two digit reporting code is used to identify the zone or access code number.

**! SIA format must be used if Downlook is required.**

If the SIA format is selected the panel can be programmed to automatically generate all zone and access codes numbers eliminating the need to program these items.

If the SIA Sends Automatic Reporting Codes option is enabled the panel will operate as follows:

1. If the reporting code for an event is programmed as [00] the panel will not attempt to call the central station.
2. If the reporting code for an event is programmed as anything from [01] to [FF] the panel will AUTOMATICALLY generate the zone or access code number.
3. Bypassed zones will always be identified when partial closing the system.

The Communicator Call Direction Options can be used to disable reporting of events such as Openings/Closings. Also, if all the Opening/Closing reporting codes were programmed as [00] the panel would not report.

If the SIA Sends Automatic Reporting Codes option is disabled the panel will operate as follows:

1. If the reporting code for an event is programmed as [00] or [FF] the panel will not attempt to call central station.
2. If the reporting code for an event is programmed as anything from [01] to [FE] the panel will send the programmed reporting code.
3. Bypassed zones will not be identified when partial closing the system.

**! Do not program the second phone number for the SIA reporting code format (Section [360]) if the Automatic Reporting Code option is enabled (Section [381]).**

.....

Communicator Format .....	Section [360]
SIA Sends Automatic Reporting Codes .....	Section [381], Option [3]
Communicator Call Direction Options .....	Section [361] to [368]
SIA Identifiers .....	Appendix B

.....

**5.6.4 Residential Dial**

If Residential Dial is programmed and an event that is programmed to communicate occurs, the panel will seize the line and dial the appropriate phone number(s). Once the dialing is complete, the panel will emit an ID tone and wait for a handshake (press a 1, 2, 4, 5, 7, 8, 0, \* or # key from any phone). It will wait for this handshake for the duration of **Post Dial Wait for Handshake** timer. Once the panel receives the handshake, it will emit an alarm tone over the phone line for 20 seconds. If several alarms occur at the same time, only one call will be made to each phone number the panel is programmed to call.

.....

Communicator Format Options .....	Section [360]
Communicator Call Direction Options .....	Section [361] to [368]

.....

**5.6.5 Pager Format**

The **Communicator Format** option for either phone number can be programmed for Pager Format. If an event occurs and the **Communicator Call Direction** options direct the call to a phone number with the Pager Format selected the panel will attempt to page.

When calling a pager extra digits will be required to make it work properly.

The following is a list of Hex digits and what function they perform:

- |   |                                      |
|---|--------------------------------------|
| Hex [B] - simulates the [*] key on a touch tone phone | Hex [E] - two second pause           |
| Hex [C] - simulates the [#] key on a touch tone phone | Hex [F] - end of phone number marker |
| Hex [D] - forces the panel to search for dial tone    |                                      |

The panel will attempt to call the pager one time. After dialing the digits in the phone number the panel will send the account number and reporting code followed by the [#] key (Hex [C]).

There is no ringback when using Pager Format. The panel has no way of confirming if the pager was called successfully; a failure to communicate trouble will only be generated once the maximum number of attempts has been reached.

**! The Pager Format cannot be used with the LINKS1000 cellular communicator.**

**Do not use the digit C in a reporting code when using Pager Format. In most cases, the digit C will be interpreted as a [#], which will terminate the page before it has finished.**

*If the panel detects a busy signal, it will attempt to page again. It will make the maximum number of attempts programmed in section [160].  
Force dialing should be disabled when using Pager format.  
When using Pager format, you must program two hex digit E's at the end of the phone number.*

5.7 Communicator – Reporting Codes

Reporting codes must be programmed in order for the panel to report events to the central station. Reporting codes are two digits and can use hexadecimal digits A through F. To disable a reporting code, program it as "FF" (default setting) or "00". All reporting codes are listed and described in Appendix A "Reporting Codes."

5.7.1 Transmission Delay

The Transmission Delay feature is used to delay reporting of alarms. When a zone is violated and causes an alarm, the **Transmission Delay Timer** will start. When the timer expires, the panel will transmit the programmed reporting code. If the system is disarmed before the timer expires, the alarm will not be transmitted.

The Transmission Delay zone attribute determines which zones will start the timer.

.....  
Transmission Delay Zone Attributes ..... Section [101]-[132], option [7]  
Transmission Delay Timer ..... Section [370]  
.....

5.7.2 Low Battery Transmission Delay

When using wireless devices, battery status will be monitored by the panel. If a low battery condition exists, the panel will indicate a general transmitter low battery trouble. The panel will delay reporting the event for the number of days programmed as the **Low Battery Transmission Delay**. This delay provides the user with an opportunity to change the batteries on the units before the condition is reported to central station. Instruct the customer on how to change the batteries of wireless devices to gain maximum use of this feature.

.....  
Low Battery Transmission Delay ..... Section [370]  
.....

5.7.3 Cross Zone Police Code Reporting

The panel will transmit the **Cross Zone Police Code** reporting code, if programmed, when two different zones are violated within the same armed-to-armed period.

The **Burglary Verified Timer**, if programmed, will start when a zone is violated and causes an alarm. If a second zone is violated before the timer expires, the panel will transmit the Cross Zone Police Code reporting code. If the timer expires before a second zone is violated, the panel will not send the reporting code, and the timer will start again. Valid entries for the Burglary Verified timer are 000-255 minutes (000 to disable).

The **Double Hit** option allows the Cross Zone Police Code reporting code to be sent when two zone alarms occur on the same zone. The Burglary Verified timer, if programmed, also applies to the Double Hit option. Only zones programmed as Interior, Interior Delay, Interior Stay/Away, or Delay Stay/Away are included in the Double Hit option.

.....  
Cross Zone Police Code ..... Section [328]  
Burglary Verified Timer ..... Section [172]  
Double Hit ..... Section [017], option [4]  
.....

5.7.4 Delinquency Reporting

The Delinquency feature is used to monitor system activity. When the **Delinquency Transmission Delay** timer expires, the panel will transmit the Delinquency reporting code.

If the system is programmed to monitor **Activity Delinquency**, the timer will be programmed in hours. The timer will start under the following conditions:

- When the system is armed in the Stay mode
- When the system is disarmed
- When a zone is violated and restored while the system is disarmed/Stay armed (Interior, Interior Delay, Interior Stay/Away, or Delay Stay/Away zones only).

The activity delinquency timer will be ignored when the system is armed in the Away mode. Zones that are bypassed in the [\*][1] Bypass menu will not reset the timer.

If the system is programmed to monitor **Closing Delinquency**, the timer will be programmed in days. The timer will restart every time the system is disarmed.

.....  
Activity/Closing Delinquency ..... Section [380], option [8]  
Delinquency Transmission Delay ..... Section [370]  
.....

5.7.5 Maintenance

The panel will transmit a **Battery Trouble Alarm** Reporting Code when the backup battery drops below 11.5 Vdc. The **Battery Trouble Restoral** Reporting Code will not be transmitted until the battery has been charged over 12.5 Vdc.

To prevent the panel from transmitting an **AC Failure Trouble Alarm** Reporting Code during short power outages the panel will not send the signal unless AC power is lost for the amount of minutes programmed

for the **AC Failure Communication Delay**. The **AC Failure Trouble Restoral** Reporting Code will be transmitted once AC power has been restored for the amount of time programmed for AC Failure. Communication delays.

**NOTES: If AC Failure Communications Delay is programmed as 000, the AC Failure Trouble reporting code will be sent immediately.**

**For proper communication of PC5204 AC troubles, program the AC Failure Communication Delay as “000”.**

A **Bell Circuit Trouble Alarm** Reporting Code will be transmitted immediately if an open condition is measured on the Bell Output of the main panel. The **Bell Circuit Trouble Restoral** Reporting Code will be transmitted as soon as the problem is corrected.

A **Fire Trouble Alarm** Reporting Code will be transmitted immediately when an open condition is measured on any Fire type zone (See Section 5.1 “Zone Definitions”). The **Fire Trouble Restoral** Reporting Code will be transmitted as soon as the problem is corrected.

The **Auxiliary Power Supply Trouble Alarm** Reporting Code will be transmitted if the AUX output is shorted. The AUX output control incorporates a fuseless design. When excessive current is drawn the panel will automatically shut off the output. The panel will constantly check the AUX output and when the excessive current draw is removed the panel will reset the output and transmit an **Auxiliary Power Supply Trouble Restoral** Reporting Code.

A **TLM Trouble** Reporting Code can only be transmitted if an Alternate Communicator is being used (See Section 5.26 “LINKS1000 Cellular Communicator”). The panel will only transmit the signal after the time programmed for the TLM Trouble Delay. The **TLM Restoral** Reporting Code will be transmitted immediately once the trouble is restored.

A **General System Trouble** Reporting Code will be transmitted if the panel detects any of the following on the PC5204 Power Supply/Output Module: AC Power Failure, Low Battery, AUX Output Trouble, Output #1 Supervisory trouble. The **General System Trouble Restoral** Reporting Code will be transmitted when all of the listed problems are corrected.

A **General System Supervisory Trouble** Reporting Code will be transmitted if any module goes missing from the Keybus. If the module is a zone expander the panel will also transmit the **Zone Expander Supervisory Alarm Trouble** Reporting Code. The panel will send a **General System Supervisory Restoral** Reporting Code when the problem is corrected as well as a **Zone Expander Supervisory Restoral** Reporting Code if the module is a zone expander.

**5.7.6 Zone Restorals**

If the **Restoral on Bell Time-out** option is selected, the panel will send the **Zone Restoral** Reporting Code for the zone if the bell cut-off time has expired *and* the zone is secured. If the zone is not secured when the bell cut-off time expires, the panel will send the restoral immediately once the zone is secured, or when the system is disarmed. If the **Restoral on Bell Time-out** option is not selected, the panel will immediately send the **Zone Restoral** Reporting Code when the zone is secured, regardless of whether or not the alarm output is active.

---

**! 24 Hour type zones will report the restoral immediately when the zone is secured.**

---

Restoral on Bell Time-out ..... Section [380], option [2]  
 AC Failure Communication Delay Time ..... Section [370]

**5.8 Downloading**

Downloading allows programming of the entire control panel via a computer, modem and telephone line. All functions and features, changes and status, such as trouble conditions and open zones can be viewed or programmed by downloading.

---

**! When power is applied to the panel, a 6 hour downloading window can be enabled. This will allow you to perform downloading without having to do any keypad programming.**

---

If the **Answering Machine/Double Call** option is enabled (or during the first 6 hours after power up) the panel will answer incoming calls for downloading provided the following conditions occur:

1. The panel hears one or two rings then misses a ring.
2. At this point the panel will start a timer.
3. If the panel hears another ring before the **Answering Machine Double Call Timer** expires it will answer on the first ring of the second call.

The panel will immediately go on line and begin the download process unless the **Call Back** option is enabled. If enabled, the panel and computer will both hang up. The panel will then call the **Download Computer Telephone Number** and wait for the computer to answer. Once the computer answers downloading will begin.

If the **User Enabled DLS Window** option is ON, the user can activate the downloading feature for a set period of time by entering [\*] [6] [Master Code] [5].

If the **Full 6-hour User Enabled DLS Window** option is enabled, when the user opens the DLS window with [\*][6][Master code][5], the DLS window will remain open for six hours. The DLS window will remain open after a successful hang-up from a downloading call. If the **One Time 1-hour User Enabled DLS**



**Window** option is enabled, when the user opens the DLS window with [\*][6][Master code][5], the DLS window will stay open for one hour, and will close after a successful hang-up from a downloading call. After six hours upon power up, the panel will not answer incoming calls unless the **Answering Machine/ Double Call** option is enabled, or the **Number of Rings** is programmed to be more than [0].

If the **User Initiated Call-Up** option is enabled, the user can have the panel initiate a call to the downloading computer by pressing [\*][6][Master Code][6].

The **Download Access Code** and **Panel Identifier Code** are for security and proper identification. Both the panel and the computer file should have the same information programmed before attempting to download.

The time to complete a successful download can be significantly reduced with the use of the PC-Link. This adaptor makes it possible to perform on-site downloading. To **Initiate Local Downloading via the PC-Link**, enter [\*] [8] [Installer's Code] [499] [Installer's Code] [499]. All keypads will be busy for the duration of the PC-Link connection. The status LEDs will display the current system status on the keypad where the PC-Link was initiated. For more information on connecting the PC-Link, refer to your "PC-Link Download Kit Instruction Sheet".

Downloading can also be performed through the LINKS1000 cellular communicator if the phone line is disconnected. If using the LINKS1000 with Call Back, you need to program the **LINKS1000 Preamble** with the downloading phone number in order for the panel to call the computer correctly.

**! When downloading labels for LCD keypads, only the LCD keypad assigned to address 8 will receive the labels. In addition, version 1.0 and version 2.0 LCD keypads are not compatible on the same system. For more information refer to the Download Manual included with the computer software.**

Answering Machine/ Double Call .....	Section [401], Option [1]
User Enable DLS Window .....	Section [401], Option [2]
Call Back .....	Section [401], Option [3]
User Initiated Call-up .....	Section [401], Option [4]
Answering Machine Double Call Timer .....	Section [405]
Download Computer Telephone Number .....	Section [402]
Download Access Code .....	Section [403]
Panel Identifier .....	Section [404]
LINKS1000 Preamble (Downloading) .....	Section [490]
One-time 1-hour user enabled DLS window .....	Section [701], Option [7]

### 5.9 Partitions/Zone Assignment

A partition is a defined area which will operate independent of another area of the system. The panel can be divided into two partitions. For example, in an office/warehouse installation it may be necessary to limit warehouse employees from accessing the office and office employees from accessing the warehouse. Any zone can be assigned to either, or both partitions. Any Access Code can be assigned to work on either, or both partitions (See Section 3.4 "[\*] Commands, [\*][5] Programming Access Codes").

**Global Zones** are zones assigned to both partitions. A common zone will only be armed when both partitions are armed and will be disarmed when either partition is disarmed.

Keypads can be assigned to work on either partition or can be assigned for Global operation (See Section 2.6 "Keypad Assignment").

Each partition can be programmed to report using a different Account Number (See Section 5.5 "Communicator - Account Numbers").

Some of the Programmable Output options are also selectable by Partition (See Section 5.10 "PGM Outputs").

The **Partition 2 Enable** option must be programmed before Partition 2 will operate.

At default zones 1 through 8 are assigned to Partition 1. If additional zones are being used or the application requires two Partitions zones must be enabled to operate on the correct Partition.

**! Zones programmed as Null must be removed from both Partitions (See Section 5.1 "Zone Definition).**

Partition 2 is Enabled .....	Section [201], Option [1]
Partition 1 Zone Assignments .....	Section [202] to [205]
Partition 2 Zone Assignments .....	Section [206] to [209]

### 5.10 Programmable Outputs

Programmable outputs are available on the following devices:

- PGM1 and PGM2 on the PC5015 main board
- 8 low current outputs available with the PC5208 Output Module
- 4 high current outputs available with the PC5204 Power Supply/Output Module

Programming any of the outputs is a two step process. First an option from the list below must be selected for the PGM Output. Second, the output attributes must be selected. The following is a list of the programmable output options and attributes.

**5.10.1 Programmable Output Options**

**[01] Burglary and Fire Bell Output** The output will activate when the alarm output is active and will turn off when the alarm output is silenced. If the alarm output is pulsing the PGM output will pulse as well. This output will follow the activation of the alarm output (pre-alert) for delayed fire zones.

**[02] For future use**

**[03] Sensor Reset ([\*] [7] [2])**

**!** *This output will normally be active (switched to ground).*

This option is used to reset power for latching smoke detectors. The output will deactivate for five seconds when the [\*] [7] [2] command is entered (see Section 3.4 "[\*] [7] Output Functions"). The keypad buzzer will not sound for the five second period.

Please refer to the Control Panel Wiring Diagram in this manual for wiring instructions.

**!** *Only ONE of options [03] Sensor Reset, [04] 2-Wire Smoke and [20] [\*] [7] [2] Command Output Option #2 may be programmed on the same system.*

**[04] 2-Wire Smoke Support (PGM2 Only)** PGM2 may be used in conjunction with two-wire smoke detectors.

**!** *PGM Output Attributes for PGM2 when used for 2-wire smoke detector support must remain at default, Attributes 1 and 3 ON. Do not program any PGM output other than PGM2 for 2-wire smoke detector support.*

Refer to the Hook-Up diagram in this manual for wiring instructions (See Section 2.9.5 "Fire Zone Wiring - 2-Wire Smoke Detectors").

**[05] Partition/System Armed Status** The output will activate when the Partition or System is armed and deactivate when disarmed.

**[06] Ready Output** The output will activate when the Partition or System is ready to arm. The output will deactivate when the system is not secure or upon arming.

**[07] Keypad Buzzer Follow** The output will activate when any of the following events occur and will remain active for as long as the keypad buzzer is active:

- Door Chime
- Entry Delay
- Audible Exit Delay
- Auto-Arm Prealert
- 24 Hour Supervisory Buzzer Zone

**[08] Courtesy Pulse** Upon arming the output will activate for the duration of the exit delay plus two minutes. Upon entry the PGM output will activate for the duration of the entry delay plus two minutes. If more than one courtesy pulse output is required, they all must be programmed for global operation (PGM attributes 1 and 2 enabled).

**[09] System Trouble Output** The output will activate when any of the selected trouble conditions are present. It will deactivate when all the selected trouble conditions are cleared.

The PGM attributes for this option, programmed in Sections [141] to [142], differ from the standard selection of attributes. Program which trouble conditions will activate the output by selecting some or all of the following attributes:

- |   |   |                                |
|---|---|--------------------------------|
| <b>[1] .. Service Required</b><br><i>(battery, bell, general trouble,</i> | <b>[3] .. Telephone Line Trouble</b>    | <b>[6] .. Zone Tamper</b>      |
| <i>general tamper, general supervisory)</i>                               | <b>[4] .. Failure to Communicate</b>    | <b>[7] .. Zone Low Battery</b> |
| <b>[2] .. AC Failure</b>  | <b>[5] .. Fire Trouble / Zone Fault</b> | <b>[8] .. Loss of Clock</b>    |

**[10] Latched System Event (Strobe Output)** The output will activate when any of the selected system events (alarms) occur on the system. In the armed state, the output will deactivate only once the system is disarmed. If an alarm activates this output in the disarmed state, the output will deactivate if a user enters a valid access code while the Bell Cut-off timer is counting down. The output will also deactivate if someone arms the system after the Bell Cut-off has expired. This output can be used to indicate that an alarm has occurred before entering the premises.

The PGM attributes for this option, programmed in Sections [141] to [154], differ from the standard selection of attributes. Program which events will activate the output by selecting some or all of the following attributes:

- [1] .. Burglary** (Delay, Instant, Interior, Stay/Away and 24 Hour Burglary Zones)
- [2] .. Fire** (Fire Keys, Fire Zones)
- [3] .. Panic** (Panic Keys and Panic Zones)
- [4] .. Medical** (Auxiliary Keys, Medical and Emergency Zones)
- [5] .. Supervisory** (Supervisory, Freezer and Water Zones)
- [6] .. Priority** (Gas, Heat, Sprinkler and 24 Hour Latching Zones)
- [7] .. Holdup** (Holdup zones)
- [8] .. Output follows pulse timer** (Section [164])

**!** *This output will activate for silent and audible alarms or medical conditions only. It will not activate during pre-alert or delays.*

**[11] System Tamper** The output will activate when any Tamper condition is present and will deactivate when all Tamper conditions are cleared.

**[12] TLM and Alarm** The output will activate when a telephone line fault condition is present AND an alarm occurs. The output will remain active until an access code is entered. The output will activate for both audible and silent alarms if a TLM trouble is present.

---

**!** *This output will activate for all audible and silent alarms except Duress.*

---

**[13] Kissoff** The PGM Output will activate for two seconds after the panel receives the kissoff from the central station.

**[14] Ground Start** The output will activate for two seconds before the panel attempts to dial to obtain dial tone on Ground Start telephone equipment. Two second pauses should be inserted at the beginning of the phone number when using this option.

**[15] Remote Operation (DLS-1 Support)** This output can be activated and deactivated remotely using DLS software.

**[16] LINKS1000 Support (PGM1 Only)** The output will be used as a data wire to communicate phone number information for the LINKS1000 cellular unit.

**[17] Away Armed** The output will activate when the system is armed with the Stay/Away zones activated.

**[18] Stay Armed** The output will activate when the system is armed with the Stay/Away zones bypassed.

**[19] [★] [7] [1] Command Output Option #1**

**[20] [★] [7] [2] Command Output Option #2** Press [★] [7] [2] [Access Code, if required] to activate any output programmed as **one of** PGM output option [03], [04] or [20].

Traditionally, [★] [7] [2] has been reserved for resetting smoke detectors. Smoke detectors should now be programmed as output [03] "Sensor Reset".

---

**!** *Only ONE of options [03] Sensor Reset, [04] 2-Wire Smoke and [20] [★] [7] [2] Command Output Option #2 may be programmed on the same system.*

---

**[21] [★] [7] [3] Command Output Option #3**

**[22] [★] [7] [4] Command Output Option #4** These outputs are user-initiated by entering [★] [7] [1-4] at any keypad. When any output is activated, three acknowledgment beeps are heard.

**[23] Silent 24 Hour (PGM2 Only)** A Panic button may be placed on the PGM2 terminal for use as a silent 24 hour Panic. The keypad will not indicate the alarm in any way and the Bell will remain silent but the PGM2 Alarm reporting code will be sent to the central station. PGM output option [23] will not activate other programmable outputs of any kind. This input does not follow Swinger Shutdown.

**[24] Audible 24 Hour (PGM2 Only)** A Panic button may be placed on the PGM2 Terminal for use as an Audible 24 Hour Panic. When the button is pressed, LCD keypads will indicate "System in Alarm", the bell will sound until the Bell Cut-off expires, and the PGM2 Alarm reporting code will be sent to the central station. PGM output option [24] will not activate other programmable outputs except for outputs programmed as [01]. This input does not follow Swinger Shutdown.

**[25] Delay Fire and Burglary**

This option operates similar to the Fire and Burglary Output (Type 01) except that it will follow the transmission delay timer programmed in Section [370]. When the timer expires, the output will activate. This is a global output.

.....

Main Board PGM Outputs .....	Section [009]
PC5208 PGM Output Options .....	Section [010]
PC5204 PGM Output Options .....	Section [011]

.....

### 5.10.2 Programmable Output Attributes

In addition to programming the output type, you must also program the PGM output attributes for each output. PGM output options [09] "System Trouble" and [10] "Latched System Event" have their own unique set of attributes listed below the description of each output type.

PGM output options [01], [03]-[08], [11]-[24] have the following attributes:

<b>Attribute</b>	<b>ON</b>	<b>OFF</b>
<b>[1]</b>	<b>Partition 1 controls event</b>	<b>Partition 1 Does Not</b>
<b>[2]</b>	<b>Partition 2 controls event</b>	<b>Partition 2 Does Not</b>
<b>[3]</b>	<b>True Output</b> The output energizes when activated (except for Option [03] Sensor Reset).	<b>Inverted Output</b> The output will de-energize when activated.
<b>[4]</b>	<b>5 Second Pulse</b> The output will activate once for 5 seconds (by default) when initiated by the user. <i>NOTE: The pulse timer can be changed in Programming Section [164]</i>	<b>Output ON/OFF</b> The output will turn ON and OFF when initiated by the user ( <i>only applicable to options [19] to [22]</i> ).
<b>[5]</b>	<b>Access Code Req.</b> The output requires a code for activation.	<b>No code Req.</b> No code required. ( <i>only applicable to keypad-activated outputs</i> )

PGM attributes return to their default settings when you change PGM output options. Please see the programming worksheets for a list of the default settings for each PGM output type. Care should be taken in selecting the normal and active states of each PGM output to ensure that an undesirable output state does not occur after a loss and restore of AC power.

**! Attribute [2] (Partition 2 controls event) is turned off by default for all output options. Attribute [3] must be ON (default) for PGM output options [04], [16], [23] and [24].**

If you program more than one PGM output as the same output type (e.g. If PGM1 and PGM2 are both programmed as [19] Command Output 1), the settings for output attributes [1], [2] and [5] must be the same. This does not apply to outputs programmed as types [09] and [10].

PGM Output Attributes .....	Section [141]-[142]
PC5208 Attributes .....	Section [143]-[150]
PC5204 Attributes .....	Section [151]-[154]
PGM Output timer .....	Section [164]

### 5.11 Telephone Line Monitor (TLM)

When the **TLM Enable** option is selected, the panel will supervise the phone line and will indicate a trouble condition if the phone line is disconnected.

If the TLM Enable option is ON, the panel will check the telephone line every 10 seconds. If the telephone line voltage is below 3V for the number of checks programmed in the **TLM Trouble Delay** section, the panel will report a TLM trouble. The default number of checks is 3. Enter a number from [000] to [255] in the TLM Trouble Delay section to change the number of checks before the TLM trouble is reported. Programming a delay means that a momentary interruption of the phone line will not cause a trouble condition.

If the **TLM Trouble Beeps When Armed** option is enabled, the panel will indicate a TLM trouble at the keypad while the system is armed. To activate the bell output in the case of a TLM trouble while the system is armed, the **TLM Audible (Bell) When Armed** option must be selected.

When the trouble condition is restored, the panel can send a **TLM Restoral** reporting code. Any events which occur while the phone line is down will also be communicated.

If the LINKS1000 Cellular Communicator, or an Alternate Communicator is being used, the panel can be programmed to report a **TLM Trouble Reporting Code**.

TLM Enable/Disable .....	Section [015], Option [7]
TLM Trouble Beeps When Armed or TLM Audible (Bell) When Armed .....	Section [015], Option [8]
TLM Trouble Reporting Code .....	Section [349]
TLM Restoral Reporting Code .....	Section [350]
TLM Trouble Delay .....	Section [370]

### 5.12 Siren

The siren will silence after the number of minutes programmed for the **Bell Cut-off** time have passed.

The panel supervises the Bell output. If an open condition is detected, the panel will immediately indicate a trouble condition by beeping the keypad twice every 10 seconds to alert the owner of the problem. The panel can send a **Bell Circuit Trouble** and **Trouble Restoral** reporting codes to indicate the situation (see Section 5.8 "Communicator – Reporting Codes").

If the **Temporal Three Fire Signal** option is enabled, all Fire signals will follow the Temporal Three Pattern as described in NFPA 72. If turned OFF all Fire signals will sound a one second on, one second off cadence.

If **Fire Bell Continuous** is enabled, the alarm output will sound until a code is entered. If disabled, the alarm will sound until a code is entered or the bell cut-off time has expired.

**! Only fire zones will follow the Temporal Three Fire Signal.**

Bell Cut-off .....	Section [005]
Bell Circuit Trouble Reporting Code .....	Section [349]
Bell Circuit Trouble Restoral Reporting Code .....	Section [350]
Temporal Three Fire Signal Enable/Disable .....	Section [013], Option [8]
Fire Bell Continuous .....	Section [014], Option [8]

### 5.13 Test Transmission

To ensure that the communication link with the central station is functioning properly, the panel can be programmed to send a test transmission signal on a regular basis.

The panel can send a **Periodic Test Transmission Reporting Code** at the programmed **Test Transmission Time of Day**. The **Test Transmission Cycle** determines the period of time between tests. The option **Land Line Test Transmission in Minutes/Days** allows you to select whether the Land Line Test Transmission cycle will be counted in minutes or days. If you have selected the test transmission cycle to be in minutes, the Test Transmission Time of Day counter will not apply.

**! The LINKS Test Transmission can only be programmed in days.**

**The Test Transmission Cycle must be greater than 10 minutes. A cycle timer of less than 10 minutes will cause damage to the control panel.**

When the test transmission cycle is programmed, the panel will send a test transmission the following day. This will indicate the beginning of the new test transmission cycle to central station.

The panel can also send a test for the LINKS1000 Cellular Communicator, if being used. If the **LINKS1000 Test Transmission Code** is programmed, the panel will send a cellular test at the interval programmed in the **LINKS Test Transmission Cycle**.

The end user can generate a communicator test. If the **System Test Reporting Code** is programmed, the panel will send the signal when the System Test keypad command is entered (see Section 3.4 – “[\*] Commands: [\*] [6] User Functions”).

.....	.....	.....
Test Transmission Reporting Codes .....	Section [352]	
Test Transmission Time of Day .....	Section [371]	
Test Transmission Cycles .....	Section [370]	

### 5.14 Fire, Auxiliary, Panic Keys

The emergency keys are available on all keypads. These keys must be pressed and held for 2 seconds before they will activate. This 2 second delay is designed to help prevent accidental activation.

If the **Fire Keys** option is enabled, when the Fire keys are pressed and held for 2 seconds, the panel will activate the alarm output. It pulses one second on, one second off only if option 8 of Section [013] is disabled (Standard Fire option). If **Fire Bell Continuous** is selected the alarm output will sound until a code is entered, otherwise it will sound until a code is entered or the alarm output times out.

Communication of the signal to central station is immediate.

If the **Auxiliary Keys** are pressed and held for 2 seconds the panel will sound the keypad beeper three times to verify activation. The panel will beep the keypad ten times rapidly to verify communication to the central station.

If the **Panic Keys** are pressed and held for 2 seconds, the panel will immediately communicate the signal to central station. If **Panic Keys Audible** is enabled, the panel will beep the keypad three times upon activation and activate the alarm output until a code is entered or the alarm output times out. Otherwise the alarm will be completely silent.

**! The Fire, Auxiliary, Panic keys will operate even if Keypad Blanking and Keypad Lockout are active (See Sections 5.22 “Keypad Lockout” and 5.23 “Keypad Blanking”).**

.....	.....	.....
Fire Keys Enable.....	Section [015], Option [1]	
Panic Keys Audible .....	Section [015], Option [2]	
Fire Bell Continuous .....	Section [014], Option [8]	

### 5.15 Entry/Exit Delay Options

Upon arming, the panel will begin the exit delay. If **Audible Exit Delay** is enabled the keypad will beep every second until the exit delay expires. The keypad will beep rapidly for the last 10 seconds of exit delay to warn the user the system is about to arm.

For commercial applications **Bell Squawk on Exit Delay** may be enabled. The panel will squawk the alarm output once every second when the exit delay is initiated and 3 times a second for the last 10 seconds until the exit delay expires.

Upon entry, if a Delay type zone is violated, the panel will begin entry delay. The keypad will emit a steady tone. The keypad will pulse the keypad sounder during the last 10 seconds to warn the user the system is about to go into alarm. If there was an alarm during the armed period, the keypad sounder will pulse for the entire entry delay to warn the user of the previous alarm.

For commercial applications **Bell Squawk on Entry Delay** may be enabled. The panel will squawk the alarm output once every second until the entry delay expires or the system is disarmed. This feature must not be used with 2 partitions.

**! Since two Delay zones are programmable, and therefore two different Entry Delays, when the panel is armed it will use the Entry Delay for the first Delay zone violated.**

If the **Bell Squawk During Auto Arm** option is enabled, the bell will squawk while the system is auto-arming in order to notify anyone on the premises that the system is being armed.

If **Exit Delay Termination** is enabled the panel will monitor the Delay zones during exit delay. If a Delay type zone is violated then secured during the exit delay, the exit delay will be terminated and the panel will be armed immediately.

To prevent false alarms, use the built-in feature **Audible Exit Fault**. If a delay type zone is violated within 4 seconds after the exit delay has expired, the panel will sound the entry delay warning through the keypad and siren alerting the customer that an improper exit was made. If the panel is disarmed within the entry delay no signal is sent. If not, the panel will continue to sound the alarm and send a signal to central station. This feature can be disabled in Section [013] Option [6].

.....	.....	.....
Bell Squawk During Auto Arm .....	Section [014], Option [2]	
Bell Squawk on Exit Delay .....	Section [014], Option [3]	

Bell Squawk on Entry Delay ..... Section [014], Option [4]  
 Audible Exit Delay ..... Section [014], Option [6]  
 Audible Exit Fault ..... Section [013], Option [6]  
 Exit Delay Termination ..... Section [014], Option [7]

5.16 Event Buffer

The panel will store the last 128 events that have occurred on the system. Each event will contain the time, date, partition and the event itself along with the zone number, access code number or any other information pertaining to the event.

If the **Event Buffer Follows Swinger Shutdown** feature is enabled the event buffer will not store events after the swinger shutdown level has been reached. This will prevent the panel from overwriting the entire buffer if a problem exists. (See Section 5.17 "Swinger Shutdown".)

The event buffer can be viewed three different ways. It can be viewed through an LCD keypad, printed on-site using the PC5400 printer module (See Section 5.29 "On-Site Printer") or it can be uploaded through the DLS software.

5.16.1 Viewing the Event Buffer

The following is the procedure for viewing the event buffer through the LCD keypad:

Step 1 - Enter [★] [6] [Master Code]

Step 2 - Select 'View Event Buffer'

The keypad will display the Event Number, Partition, Time and Date of the event in question. Use the [★] key to toggle between this information and the event itself. Use the arrow keys (<->) to scroll through the events in the buffer.

When you have finished viewing the event buffer press the [#] key to exit.

Event Buffer Follows Swinger Shutdown ..... Section [013], Option [7]

5.17 Swinger Shutdown

The swinger shutdown feature is designed to prevent a runaway communicator from tying up the central station. Different limits can be programmed for **Zone Alarms**, **Zone Tamper**s and **Maintenance** signals. After the panel has communicated the programmed number of transmissions for an event it will no longer report that event until the swinger shutdown is reset.

For example, the swinger shutdown limit for Zone Alarms is set to [003]. The panel will not send more than 3 alarm signals for each zone with a swinger attribute until the swinger shutdown is reset.

The Bell output will not be activated for alarms on zones that have exceeded the limit of alarms set in the Swinger Shutdown counter.

**Swinger Shutdown** will be reset when the panel is armed or every day at midnight. Once reset, the panel will again communicate normally.

Swinger Shutdown Limit (Alarms/Tampers/Maintenance) ..... Section [370]

5.18 Daylight Savings Time

If the **Daylight Savings Time** option is enabled, the panel will follow the daylight savings time change. At 2 a.m. on the first Sunday in April, the panel clock will be set forward one hour to 3 a.m. At 2 a.m. on the last Sunday in October, the panel clock will be set back one hour to 1 a.m.

**! Events programmed to occur between 2 and 3 a.m. will not occur on the first Sunday in April. Events programmed to occur between 1 and 2 a.m. will occur twice on the last Sunday in October.**

Daylight Savings Time ..... Section [017], option [6]

5.19 Keypad Backlighting

The keys of all the keypads can be backlit to provide easy viewing in dim lighting conditions. If the **Keypad Backlighting Option** is enabled the keys will be illuminated.

Keypad Backlighting Option ..... Section [016], Option [5]

5.20 Arming /Disarming Options

If the **Arm/Disarm Bell Squawk** option is enabled the panel will squawk the alarm output once upon arming and twice upon disarming. The **Opening After Alarm Keypad Ringback** option will give you the ability to beep the keypad 8 times rapidly if the panel is disarmed after an alarm occurred. The **Opening After Alarm Bell Squawk** option will give you the ability to squawk the bell output 8 times rapidly if the panel is disarmed after an alarm occurred.

**Closing Confirmation**, if enabled, will cause the keypad to beep 8 times rapidly after the closing reporting code has been successfully transmitted to central station.

If the **Bypass Status Displayed While Armed** option is chosen, the Bypass light will be ON while the system is armed to indicate that there are bypassed zones.

If the panel is armed using the Stay function key, or by entering [\*][9][access code], there will be no bell squawks during entry and exit delays, except for the arm/diarm bell squawks.

**!** *If the panel is armed using the Stay function key there will be no bell squawks during the exit delay except for the arm bell squawk. If the panel is no-entry armed using [\*][9][access code], there will be no bell squawks during the exit delay, except for the arm/disarm bell squawks. There is no entry delay (and no bell squawks) when the panel is no-entry armed.*

If **WLS Key Uses Access Codes** is enabled, the disarm button will *not* work on wireless keys which have not been assigned access codes. (Please see your PC5132 manual for more information on programming wireless keys.)

**!** *This option must be enabled when using a PC5132 v2.1 or earlier. Therefore, Section [017] option [1] must be ON.*

.....	.....
Arm/Disarm Bell Squawk .....	Section [014], Option [1]
Bypass Status Displayed While Armed .....	Section [016], Option [7]
WLS Key Uses Access Codes.....	Section [017], Option [1]
Opening After Alarm Keypad Ringback .....	Section [381], Option [1]
Opening After Alarm Bell Ringback .....	Section [381], Option [2]
Closing Confirmation .....	Section [381], Option [4]
.....	.....

## 5.21 Automatic Arming

Each Partition can be programmed to auto arm at a specific time every day if it is in the disarmed condition. Up to 14 auto arm times can be programmed on the system: one for each day of the week for Partition 1 and Partition 2.

Once the auto arm times have been programmed, three items must be enabled in order to activate the auto arming function:

1. The correct **Time of Day** must be programmed. For instructions on programming the time and date, see the PC5015 Instruction Manual ("Setting the Time and Date").
2. Enter [\*][6][2] to enable (three keypad beeps) or disable (one long beep) the auto arm feature.
3. Program the auto-arm time for each day of the week, for each partition, in programming sections [180]-[193].

**!** *Items 2 and 3 are programmable by partition. Program these items at a keypad assigned to the correct partition (See section 2.6 "Keypad Assignment").*

If the **Partition 1 Auto-arm Schedule in [\*][6]** feature is enabled, users with access to partition 1 will be able to change the partition 1 auto-arm time of day, for each day of the week. If the **Partition 2 Auto-arm Schedule in [\*][6]** feature is enabled, users with access to partition 2 will be able to change the partition 2 auto-arm time of day for each day of the week. See section 3.4 "[\*] Commands" for a description of the [\*][6][3] menu.

When the internal panel clock matches the programmed **Auto Arm Time** for that day, the panel will check the status of the partition. If the partition is armed, the panel will do nothing until the programmed auto arm time for the next day when it will check again.

If the partition is disarmed, the panel will sound the buzzer of all keypads assigned to the partition for one minute. This is the auto arm pre-alert period. Please note that if there is an auto-arm time programmed for that day, the panel will sound the pre-alert *whether or not auto-arming is enabled* (in the [\*][6][2] menu).

If a valid access code is entered during the auto arm pre-alert period, the **Postpone Auto Arm Timer** will begin. If the timer programmed as [000], auto arming will be cancelled. If the timer is programmed from [001]-[225] minutes, the panel will postpone auto arming for the programmed time. Once the timer is expired, the auto arming sequence will begin again, at which point a valid access code may be entered to postpone the procedure. Auto arming may continue to be postponed multiple times. The panel will transmit an **Auto Arm Postpone Reporting Code** each time auto arming is postponed, if programmed.

If no code is entered, the panel will auto arm. If a zone is violated the panel will transmit a **Partial Closing Reporting Code** if programmed to indicate the system was not secure. If the zone is restored the panel will add the zone back into the system.

### Late to Close

If the **Late to Close** option is enabled, the panel will transmit the Late to Close reporting code whenever the auto-arm pre-alert sounds. If there is an auto-arm time programmed for that day, the panel will transmit the reporting code *whether or not auto-arming is enabled* (in the [\*][6][2] menu). The Late to Close reporting code must also be programmed for this feature to function.

.....	.....
Program Time and Date .....	[*][6][1]
Enable Auto Arming .....	[*][6][2]
Enable Auto Arm Day .....	[*][6][3]
Auto Arm Times .....	Sections [180]-[193]
Auto Arm Postpone Reporting Code .....	Section [348]
Partial Closing Reporting Code .....	Section [343]
Late to Close Enable/Disable .....	Section [017], option [5]
Late to Close reporting code .....	Section [343]
Partition 1 or 2 Auto-arm Schedule in [*][6] .....	Section [017], options [2] & [3]
.....	.....

5.22 Keypad Lockout

The panel can be programmed to 'lockout' keypads if a series of incorrect access code entries are made. After the **Number of Invalid Codes Before Lockout** has been reached the panel will lock out the keypad for the **Lockout Duration** and log the event to the event buffer. For the duration of the lockout the panel will sound an error tone when any key is pressed. The invalid code counter will be reset every hour. To disable Keypad Lockout program the **Number of Invalid Codes Before Lockout** as [000].

**! If Keypad Lockout is active, the panel cannot be armed/disarmed with a keyswitch.**

.....  
 Number of Invalid Codes Before Lockout ..... Section [012]  
 Lockout Duration ..... Section [012]  
 Keypad Lockout Reporting Code ..... Section [338]  
 .....

5.23 Keypad Blanking

If the **Keypad Blanking Option** is enabled the panel will turn off all lights and LCDs on the keypads if no key is pressed for 30 seconds. The keys, however, will remain backlit. The panel will turn the lights and LCDs back on if entry delay begins or an audible alarm occurs. The lights and LCDs will also come on if a key is pressed or, if the **Code Required to Restore Blanking Option** is enabled, a valid access code is entered.

If the **Power Save Option** is enabled the panel will blank all keypad lights including backlighting when AC power fails, in order to conserve the back up battery.

.....  
 Keypad Blanking Option ..... Section [016], Option [3]  
 Code Required to Restore Blanking ..... Section [016], Option [4]  
 Power Save Option ..... Section [016], Option [6]  
 .....

5.24 Loop Response

The normal loop response time for all zones is 500 milliseconds. The panel will not consider a zone violated unless it is violated for at least 500 milliseconds.

If **Zone 1 is Fast Loop Response** is enabled the loop response for zone 1 will be 40 milliseconds. Typically this can be used for vibration type sensors.

.....  
 Zone 1 is Fast Loop Response ..... Section [013], Option [5]  
 .....

5.25 Keypad Tamper

If the **Keypad Tamper Enable** option is selected the panel will display and transmit a **General System Tamper** reporting code if any keypad is removed from the wall. When the keypad tamper is restored the panel will transmit the **General System Tamper Restoral** reporting code. All keypads should be properly installed and secured before enabling this option.

By enabling **Tampers/Faults Do Not Show as Open**, faults and tampers for keypad zones will not show as open on the keypad, and will be hidden from the end user. If the option is disabled, faults and tampers will show as open.

**! Entering and exiting Installer's Programming will not reset the system tampers. All tamper conditions must also be physically restored. Once a zone is tampered or faulted, it must be completely restored before the trouble condition will clear.**

.....  
 Keypad Tamper Enable ..... Section [016], Option [8]  
 General System Tamper Reporting Code ..... Section [338]  
 General System Tamper Restoral Reporting Code ..... Section [338]  
 Tamper/Fault Do Not Show As Open ..... Section [013], Option [4]  
 .....

5.26 LINKS1000 Cellular Communicator

The LINKS1000 cellular communicator can be used three different ways: as the sole communicator for the panel, as a back up for either or both phone numbers or as a redundant back up to the land line communicator (the panel will call both the land line and via the LINKS). A **LINKS Preamble** is programmable for each phone number in the event that the land line number is local but the LINKS is required to dial an exchange. When programming a LINKS Preamble, all unused digits must be programmed with a hex decimal "F".

5.26.1 Sole Communicator

The panel can be programmed to report only using the LINKS1000 cellular communicator when an event occurs. To program this select only the LINKS1000 for the **Communicator Call Direction** Options for the event. In addition the **Call LINKS as well as Land Line** option must also be enabled. When the selected event occurs the panel will only attempt to call central station using the LINKS.

5.26.2 Backup Communicator

The panel can be programmed to call using the LINKS1000 cellular communicator if the panel is having difficulty communicating an event using the land line. To program this select both the phone number and LINKS options for the Communicator Call Direction Options for the event. In addition the LINKS is Backup of Land Lines option must be selected.



When used as a backup communicator the panel will attempt to call the central station in the following manner:

- the panel will try to call using land lines - if unsuccessful the panel will try to call using the LINKS
- if unsuccessful the panel will try to call using the land lines
- if unsuccessful the panel will try to call using the LINKS

This process will continue until the panel has successfully communicated with the central station or the **Maximum Dialing Attempts** has been reached.

**5.26.3 Redundant Communicator**

The panel can be programmed to call using both the land line and the LINKS1000 cellular communicator when an event occurs. To program this select both the phone number and the LINKS options for the **Communicator Call Direction** Options for the event. In addition the **Call LINKS** as well as **Land Line** option must be selected. The panel will call the LINKS and then call the land line when reporting the selected event.

**5.26.4 LINKS Special Preamble**

In some areas of North America, dialing #DAT or ★DATA reduces the cellular billing increment. The **LINKS Special Preamble** (section [393]), allows the use of [★] and [#] characters for the programming of #DAT and ★DATA.

The LINKS Special Preamble is sent BEFORE the Preamble programmed in Sections [390] to [392].  
Example: [Special Preamble][Regular Preamble][Telephone Number]

**! If this Special Preamble is programmed, it will be inserted before the Regular Preamble of ALL telephone numbers. Hex digits D and E are not supported for Preamble programming. If Busy Tone Detection is enabled, the LINKS1000 must be tested to ensure full operation.**

Please refer to the LINKS1000 installation Manual for more information and connection diagrams.

.....

LINKS Preamble (First Telephone Number) ..... Section [390]

LINKS Preamble (Second Telephone Number) ..... Section [391]

LINKS Preamble (Third Telephone Number) ..... Section [392]

LINKS Preamble (All Telephone Number) ..... Section [393]

LINKS Preamble (Downloading Telephone Number) ..... Section [490]

Communicator Call Direction Options ..... Section [361] to [368]

Call LINKS as well as Land Line ..... Section [380], Option [7]

Maximum Dialing Attempts ..... Section [160]

.....

**5.27 Module Programming**

The programming sections listed below pertain to additional modules on the system. For instructions on programming these modules and a description of each programming section, see their respective installation manuals.

.....

PC5400 Programming ..... Section [801]

PC5928 Programming ..... Section [802]

Alternate Communicator Programming ..... Section [803]

PC5132 Programming ..... Section [804]

PC5108L Programming ..... Section [806]

.....

**5.27.1 PC5928 Audio Interface Module**

The PC5928 Audio Interface will allow you to connect up to 7 Interior (PC5921) or exterior (PC5921EXT) Intercom Stations. These attractive, surface mount stations contain both speaker and microphone and will allow you to add intercom features to your alarm system such as:

- Page/Answer
- Do Not Disturb
- Baby Listener Broadcast
- Answer Incoming Calls
- Doorbell Function
- Background Music

In addition to these features the module also has the Listen-in feature for central station monitoring. The central station can select the audio station, listen/talk, extend on-line time and hang up. The Listen-In feature can be enabled separately for telephone numbers 1/3 and 2.

**! All talk/listen and/or video sessions will be disconnected if the panel needs to communicate alarms to the central station.**

.....

Phone 1 & 3 Listen-In Enabled ..... Section [381], Option 5

Phone 2 Listen-In Enabled ..... Section [381], Option 6

.....

**5.27.2 Periodic Camera Test**

When the **Periodic Camera Test** option is enabled, the panel will test cameras connected to a PC5108L module every 30 minutes. Only cameras with the Camera Test option enabled will be tested. See your PC5108L Installation Manual for more information on camera tests.

.....

Periodic Camera Test ..... Section [017], Option [7]

.....

**5.28 Default (Factory)**

On occasion it may be necessary to default the main control panel or one of the modules that can be connected. There are several different defaults available including defaulting the main control panel, Escort5580 module, PC5132 Wireless Expander Module, PC5400 Printer module and an Alternate Communicator module.

**Note: Defaulting the main panel does not default the keypads. Please refer to “Programming LCD5500Z Keypads” in the Programming Worksheets for defaulting the LCD5500Z. PC55XXZ LED keypads must be manually reprogrammed in installers section [000].**

**5.28.1 Factory Default Main Panel (Hardware)**

- Step 1 - Remove AC and battery from the panel.
- Step 2 - Remove all wires from the Zone 1 and PGM1 terminals.
- Step 3 - With a piece of wire short the Zone 1 terminal to the PGM1 terminal.
- Step 4 - Apply AC power to the main panel.
- Step 5 - When Zone Light 1 is lit on the keypad the default is complete.
- Step 6 - Remove AC power from the control
- Step 7 - Reconnect all original wiring and power up the control.

---

**! AC power must be used to power the panel. The panel will not default if the battery is used.**

---

**5.28.2 Factory Default Main Panel (Software) and other Modules**

- Step 1 - Enter Installer Programming.
  - Step 2 - Enter Program Section [99X].
  - Step 3 - Enter the Installer Code.
  - Step 4 - Enter Program Section [99X] again.
- The panel will take a few seconds to reset. When the keypad is operational, the default is complete.

Restore Alternate Communicator to Factory Default Programming ...	Section [993]
Restore Escort5580 to Factory Default Programming .....	Section [995]
Restore PC5132 to Factory Default Programming .....	Section [996]
Restore PC5400 to Factory Default Programming .....	Section [997]
Restore PC5928 to Factory Default Programming .....	Section [998]
Restore Main Panel (Software) to Factory Default Programming .....	Section [999]

**5.29 Installer Lockout**

If **Installer Lockout** is selected a hardware default cannot be performed. If a software default is performed all programming will restore to factory default. When **Installer Lockout Disable** is selected the panel will restore all programming to factory defaults if a hardware or software default is performed on the main control panel.

To enable or disable Installer Lockout perform the following:

- Step 1 - Enter Installer Programming.
  - Step 2 - Enter Program Section [99X].
  - Step 3 - Enter the Installer Code.
  - Step 4 - Enter Program Section [99X] again.
- |                                 |               |
|---------------------------------|---------------|
| Installer Lockout Enable .....  | Section [990] |
| Installer Lockout Disable ..... | Section [991] |

**5.30 Walk Test (Installer)**

The **Installer Walk Test** can be used to test the alarm state of each zone of the panel. The walk test cannot be used to test zone type [24].

Before beginning the walk test, ensure the following conditions are met:

1. The panel is disarmed
2. The Keypad Blanking option is disabled (section [016]: [3])
3. The Fire Bell is Continuous option is disabled (section [014]: [8])
4. The Transmission Delay is disabled, if Transmission Delay is not required (section [370])

---

**! Fire Troubles are not supported in Walk Test. All outputs will activate for both partitions during the walk test, regardless of programming.**

---

To perform a Walk Test, do the following:

- Step 1 - Enter Installer Programming
- Step 2 - Enter Section [901]

When any zone is violated the panel will activate the Bell Output for two seconds, log the event to the Event Buffer and communicate the alarm to central station. Each zone should be tested several times during the test. Check the event buffer to ensure that all zones and FAP keys are functioning properly.

To stop the test, you must do the following:

- Step 1 - Enter Installer Programming
- Step 2 - Enter Section [901]

Zones do not have to be restored to stop the test. After the test is complete, check the Event Buffer to ensure that the Audible/Silent 24-hr PGM alarms have been restored.

---

**! The Alarm Memory is cleared upon entering Walk Test mode. When the Walk Test is complete, the Alarm Memory light will remain lit, but there will be no alarms in memory. The light will turn off the next time the panel is armed.**

---

# Reporting Codes

## A P P E N D I X A

### Contact ID

The first digit (in parentheses) will automatically be sent by the control. The last two digits are programmed to indicate specific information about the signal.

For example, if zone 1 is an entry/exit point, the alarm reporting code could be programmed as [34]. The central station would receive the following:

#### \*BURG - ENTRY/EXIT - 1

In the above example, the "1" indicates which zone went into alarm.

### SIA Format (Level 2—Hardcoded)

This format will send the Account Code along with its data transmission. At the receiver, the transmission would look similar to this example:

N Ri01 BA 01

N = New Event

Ri01 = Partition /Area Identifier

BA = Burglary Alarm

01 = Zone 1

**Table A-1: PC5015 Reporting Codes**

Section #	Reporting Code	Code Sent When...	Dialer Direction*	Auto-matic Contact ID	SIA Auto Rep Codes**
[320-323]	Zone Alarms	zone goes into alarm	A/R	(1) 3A	See Table B-1
[324-327]	Zone Restorals	zone in alarm is restored	A/R	(1) 3A	
[328]	Duress Alarm	duress code entered at keypad	A/R	(1) 21	HA-00
[328]	Opening After Alarm	system disarmed with alarm in memory	A/R	(4) A6	OR-00
[328]	Recent Closing	alarm occurs within two minutes of system arming	A/R	(4) 59	CR-00
[328]	Zone Expander Supervisory Alarm/Rest.	panel loses/restores supervisory transmission over the Keybus from zone expansion modules or keypads with zone inputs	A/R	(1) 43	UA-00/UH-00
[328]	Cross Zone (Police Code) Alarm	two zones on the same partition go into alarm during any given armed-to-armed period (incl. 24Hr zones)	A/R	(1) 4A	BV-00
[329]	[F] Key Alarm/Rest.	Keypad fire alarm (alarm and restore rep. codes sent together)	A/R	(1) 15	FA-00/FH-00
[329]	[A] Key Alarm/Rest.	Keypad auxiliary alarm (alarm and restore rep. codes sent together)	A/R	(1) AA	MA-00/MH-00
[329]	[P] Key Alarm/Rest.	Keypad panic alarm (alarm and restore rep. codes sent together)	A/R	(1) 2A	PA-00/PH-00
[329]	PGM2 Alarm/Rest.	Output Option #23/24: a panic button wired to PGM2 is pressed/access code is entered	A/R	(1) 4A	UA-99/UH-99
		Output Option #04: a 2-wire smoke detector wired to PGM2 goes into alarm/alarm is cleared	A/R	(1) 11	FA-99/FH-99
[330-] [337]	Zone Tamper/Rest.	zone exhibits a tamper condition/tamper condition restored	T/R	(1) 44	TA-ZZ/TR-ZZ
[338]	General System Tamper/Rest.	enrolled module with tamper inputs has a tamper alarm/all module tampers restored	T/R	(1) 45	TA-00/TR-00
[338]	Keypad Lockout	max. number of incorrect access codes has been entered at a keypad	T/R	(4) 21	JA-00
[339-343]	Closings	system armed (user 01-34, 40-42 indicated)	O/C	(4) A2	CL-UU
[343]	Partial Closing	one or more zones are manually bypassed when system armed (or auto armed)	O/C	(4) 7A	CG-ZZ
[343]	Special Closing	Closing (arming) using one of the following methods: quick arm, auto arm, keyswitch, wireless key, function key, maintenance code, DLS	O/C	(4) AA	CL-00

**R E P O R T I N G C O D E S**

Section #	Reporting Code	Code Sent When...	Dialer Direction*	Auto-matic Contact ID	SIA Auto Rep Codes**
[344-348]	Openings	system disarmed (user 01-34, 40-42 indicated)	O/C	(4) A2	OP-UU
[348]	Auto Arm Cancellation	auto arm cancelled	O/C	(4) A5	CE-00
[348]	Special Opening	Opening (disarming) using one of the following methods: keyswitch, maintenance code, DLS software, wireless key	O/C	(4) AA	OP-00
[349-350]	Battery Trouble/Rest.	Main panel battery is low/battery restored	Maint.	(3) A2	YT-00/YR-00
[349-350]	AC Failure Trouble/Rest.	AC power to control panel is disconnected or interrupted/AC power restored (both codes follow AC Failure transmission delay)	Maint.	(3) A1	AT-00/AR-00
[349-350]	Bell Circuit Trouble/Rest.	open/short circuit detected across bell terminals/bell circuit restored	Maint.	(3) 21	UT-99/UJ-99
[349-350]	Fire Trouble/Rest.	a trouble occurs/restores in a fire zone	Maint.	(3) 73	FT-00/FJ-00
[349-350]	Auxiliary Power Trouble/Rest.	aux voltage supply trouble/restoral	Maint.	(3) AA	YP-00/YQ-00
[349]	TLM Failure	telephone line monitoring trouble (sent via LINKS. Do not program if LINKS not used)	Maint.	(3) 51	LT-00
[350]	TLM Restore	Telephone line trouble restore	Maint.	(3) 51	LR-00
[349-350]	General System Trouble/Rest.	"Service Required" trouble occurs (view troubles using [*][2][3])/trouble restored	Maint.	(3) AA	YX-00/YZ-00
[349-350]	Gen System Supervisory Trouble/Rest.	control panel loses/restores communications with module(s) connected to the Keybus	Misc.	(3) 33	ET-00/ER-00
[351]	Line 1 or 2 FTC Restoral	control panel has restored communications to central station on line 1or 2	Misc.	(3) 54	YK-00
[351]	Event Buffer is 75% Full	event buffer is almost full	Misc.	(6) 23	JL-00
[351]	DLS Lead In	downloading session start (initiated by panel)	Misc.	(4) 11	RB-00
[351]	DLS Lead Out	downloading session complete	Misc.	(4) 12	RS-00
[351]	General Zone Trouble/Rest.	one or more zones have trouble/trouble restored	Misc.	(3) 72	UT-00/UJ-00
[351]	Delinquency	programmed amount of time (days or hours) for delinquency has expired without zone activity or without system being armed	Misc.	(4) 54‡	CD-00
[352]	Periodic Test	periodic sytem test transmission	Test	(6) A2	RP-00
[352]	System Test	[*][6] bell/communications test	Test	(6) A1	RX-00
[352]	LINKS Test	LINKS test transmission	Test	(6) A3	TX-00
[353]	General Device Low Battery Trouble/Rest.	Wireless zones/pendants/handheld keypads/wireless keys have low battery	Test	(3) 84	XT-00/XR-00

\* A/R = alarms/restorals; T/R = tamper/restorals; O/C = openings/closings; Maint. = maintenance; Misc. = miscellaneous; Test = test transmission

\*\* UU = user number (access codes 01-42); ZZ = zone number (01-32)

‡ Program the Contact ID "Fail to close" event code [(4)54] to report either closing or activity delinquency. Make sure your central station is aware of the application of this reporting code.

# Zone Reporting Codes

## A P P E N D I X B

**Table B-1 Zone Alarm/Restoral Reporting Codes**

For notes on Contact ID or SIA formats, see Appendix A.

Zone Definition	SIA Auto Rep Codes**
Delay, Instant, Interior, Delay Stay/Away, Interior Stay/Away, 24Hr Burg.	BA-ZZ/BH-ZZ
Standard 24Hr Fire, Delayed 24Hr Fire	FA-ZZ/FH-ZZ
24Hr Supervisory	US-ZZ/UR-ZZ
24Hr Supervisory Buzzer	UA-ZZ/UH-ZZ
24Hr Sprinkler	SA-ZZ/SH-ZZ
24Hr Gas	GA-ZZ/GH-ZZ
24Hr Heat	KA-ZZ/KH-ZZ
24Hr Medical	MA-ZZ/MH-ZZ
24Hr Emergency (non-medical)	QA-ZZ/QH-ZZ
24Hr Waterflow	WA-ZZ/WH-ZZ
24Hr Freeze	ZA-ZZ/ZH-ZZ
24Hr Holdup	HA-ZZ/HH-ZZ
24Hr Panic	PA-ZZ/PH-ZZ
Latching 24Hr	BA-ZZ/BH-ZZ

\*\* ZZ = zones 01 - 32

**Table B-2: Contact ID Zone Alarm/Restoral Event Codes (as per ADEMCO):**

Program any of these codes for zone alarms/restorals when using the standard (non-automatic) Contact ID reporting format.

<b>Medical Alarms</b>	(1)33 24 Hour
(1)AA Medical	(1)34 Entry / Exit
(1)A1 Pendant Transmitter	(1)35 Day / Night
(1)A2 Fail to Report In	(1)36 Outdoor
<b>Fire Alarms</b>	(1)37 Tamper
(1)1A Fire Alarm	(1)38 Near Alarm
(1)11 Smoke	<b>General Alarms</b>
(1)12 Combustion	(1)4A General Alarm
(1)13 Water Flow	(1)43 Exp. module failure
(1)14 Heat	(1)44 Sensor tamper
(1)15 Pull Station	(1)45 Module Tamper
(1)16 Duct	<b>24 Hour Non-Burglary</b>
(1)17 Flame	(1)5A 24 Hour non-Burg
(1)18 Near Alarm	(1)51 Gas detected
<b>Panic Alarms</b>	(1)52 Refrigeration
(1)2A Panic	(1)53 Loss of Heat
(1)21 Duress	(1)54 Water Leakage
(1)22 Silent	(1)55 Foil Break
(1)23 Audible	(1)56 Day Trouble
<b>Burglar Alarms</b>	(1)57 Low bottled Gas level
(1)3A Burglary	(1)58 High Temp
(1)31 Perimeter	(1)59 Low Temp
(1)32 Interior	(1)61 Loss of Air Flow

## UL Listed Commercial and Residential Installations

The installation requirements listed below must be met for the following grades of service.

### Grade A Local

The installation must have a bell UL Listed for mecatile local alarms (AMSECO MBL10B with model AB-12 bell housing).

The digital communicator must be enabled.

The control panel must be in the Attack Resistant Enclosure (DSC Model CMC-1).

### Grade B Central Station and Police Connect

The installation must have a bell UL Listed for mecatile local alarms (AMSECO MBL10B with model AB-12 bell housing).

The digital communicator must be enabled.

The control panel must be in the Attack Resistant Enclosure (DSC Model CMC-1).

### Grade C Central Station

The digital communicator must be enabled.

The control panel must be in the Attack Resistant Enclosure (DSC Model CMC-1).

### All Commercial Installations

- The entry delay must not exceed 60 seconds
- The exit delay must not exceed 60 seconds.
- The minimum bell cutoff time is 15 minutes.

### Residential Installations

- The entry delay must not exceed 45 seconds
- The exit delay must not exceed 60 seconds.
- The minimum bell cutoff time is 4 minutes.

### Programming

The notes in the programming sections describing the system configurations for UL Listed installations must be implemented.

### Control of the Protected Premises

In order to have a UL Certificated system the protected area is to be under the responsibility of one ownership and management

(i.e. one business under one name). This may be a group of buildings attached or unattached with different addresses but under the responsibility of someone having mutual interest. The person of mutual interest is not the alarm installing company.

### Bell Location

The alarm sounding device (bell) must be located where it can be heard by the person or persons responsible for maintaining the security system during the daily arming cycle.

### Protection of the Control Unit

The local control and the local power supply must be protected by one of the following ways:

- The control unit and audible alarm device must be in a protected area which is armed 24 hours a day.
- Each partition shall arm the area protecting the control unit and the audible alarm device power supply. This may require duplicate protection armed by each partition. Access to this protected area, without causing an alarm, will require that all partitions be disarmed.

In all cases described above, the protected area for the control unit must be programmed as not bypassable.

### Casual Users

The installer should caution the user(s) to not give system information to casual users (e.g. codes, bypass methods, etc. to baby-sitters or service people). Only the One-Time Use codes should be given to casual users.

### User Information

The installer should advise the users and note in the user instruction manual:

- Service organization name and telephone number
- The programmed exit time
- The programmed entry time

# PC5015 Control Panel Wiring Diagram

## A P P E N D I X C

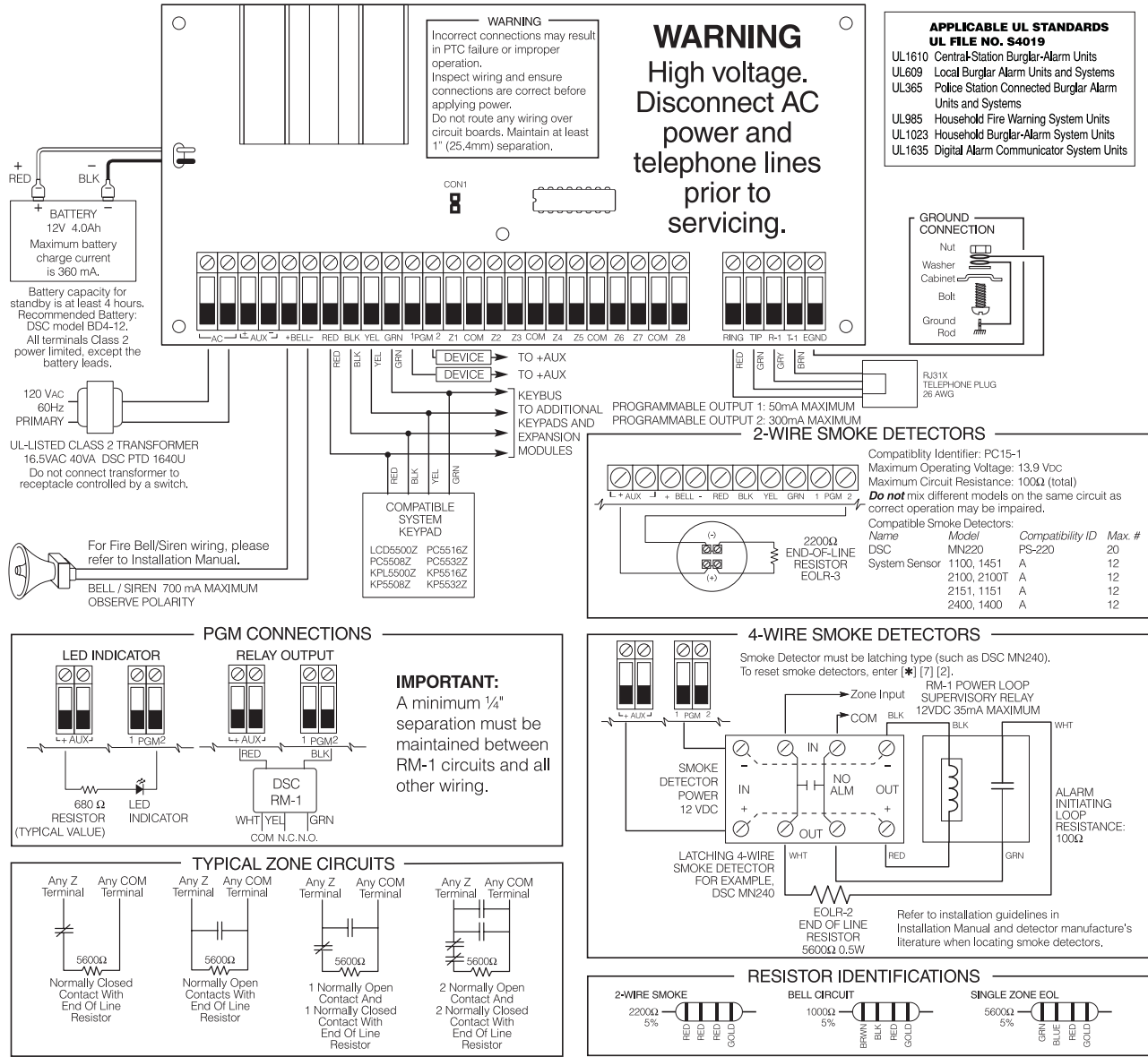

**WARNING:** Not to be removed by anyone except occupant. This equipment should be installed in accordance with Chapter 2 of the National Fire Code ANSI/NFPA 72-1993 (National Fire Protection Association, Batterymarch Park, Quincy MA, 02269). Printed information describing proper installation, operation, testing, maintenance, evacuation planning, and repair service is to be provided with this equipment.

For compliance with UL-985, at least one hard-wired smoke detector is required.

Temperature Range: 0°C-49°C (32°F-120°F)  
Maximum Humidity: 85% R.H.  
Refer to the Installation Manual #29003272 R0 and Instruction Manual #29003171 R0 for complete operating instructions.  
The PC5015 is UL-listed for limited energy installations per NEC Article 760. Recognized limited energy cable should be used. Observe NEC wiring requirements and local codes defined by the authority having jurisdiction.  
Security detection devices that require power from the control panel must be UL-listed for the intended application and operate over the range of 11.6 - 12.6 VDC (residential), 12.0 VDC (commercial). The DSC Bravo Series are recommended UL-listed motion detectors.  
Compatible System Key pads: PC5508Z/KP5508Z, PC5516Z/KP5516Z, PC5532Z/KP5532Z, LCD5500Z/KPL5500Z.

Control Panel is suitable for the following UL installations:

- Household Fire and Grade A Household Burglary
- Grade A Local I Grade B Central Station and Police Connect with basic line security
- Grade C Central Station
- Refer to Installation manuals

This device complies with Parts 15 and 68 of the FCC rules. Operation is subject to the following two conditions: (1) this device may not cause harmful interference, and (2) this device must accept any interference received, including interference that may cause undesired operation.

FCC Reg. No.: F53CAN-32104-AL-E REN = 0.6B Plug Type: RJ31X  
Made in Canada

# Modules Supported on the PC5015 v2.2

## A P P E N D I X D

Module	Supported	Comments
Escort5580	Yes	
PC5204	Yes	
PC5208	Yes	
PC5108	Yes	
PC5108L	Yes	
PC5132 v1.X	Yes	No support for Wireless Keys, Pendants or Handheld Keypads
PC5132 v2.X	Yes	No identified Wireless Keys support
PC5132 v3.X	Yes	
PC5506	No	
PC5508	Yes	No Keypad zone support
PC5508Z	Yes	
PC5516	Yes	No Keypad zone support
PC5516Z	Yes	
PC5532	Yes	No Keypad zone support
PC5532Z	Yes	
LCD5500 v1.X	Yes	No Keypad zone support; Some display messages not supported
LCD5500Z v2.X	Yes	
PC5908	No	
PC5928	Yes	
PC5400 v1.X to v2.1	Yes	Some printing messages not supported
PC5400 v2.2	Yes	
Links1000	Yes	
Links2150	Yes	
Links2450	Yes	
DLM-1	No	
DLM-4 v1.X	No	
DLM-4L v1.0L	Yes	
DLM-7	No	



---

© 1999 Digital Security Controls Ltd.  
1645 Flint Road, Downsview, Ontario, Canada M3J 2J6  
Tel. (416) 665-8460 • Fax (416) 665-7498 • Tech. Line 1-800-387-3630

**[www.dscgrp.com](http://www.dscgrp.com)**

Printed in Canada 29003272 R2