

# System Introduction

## S E C T I O N 1

### 1.1 Specifications

#### Control Panel Specifications

##### Flexible Zone Configuration:

- 8 Fully Programmable Zones
- 37 Access Codes: 32 User, 1 System Master, 2 Partition Master and 2 Duress
- Expandable to 32 Zones
- Hardwired expansion available using the PC5108 Eight Zone Expansion Module
- Wireless expansion available using the PC5132-900 Wireless Zone Expansion Module (up to 32 wireless zones, 900MHz, True Spread Spectrum Technology, Fully Supervised)
- Normally Closed, Single EOL, or Double EOL zone supervision
- 2-Wire Smoke Zone
- 27 Zone Types, 8 Programmable Zone Options
- 2 Partitions

##### Audible Alarm Output:

- Supervised Bell Output (current limited at 3 amps), 12 V<sub>DC</sub>
- Steady or Pulsed Output

##### EEPROM Memory:

- Will not lose programming or system status on complete AC and Battery failure

##### Programmable Outputs:

- Up to 14 Programmable Voltage Outputs, 18 programmable options
- One High Current (300 mA) PGM output with 2 wire smoke detector capability on main panel
- Maximum Loop Current is 1.5 mA when the 2-wire smoke detector configuration is used
- One Low Current (50 mA) PGM output on main panel
- Eight Additional Low Current (50 mA) PGM outputs available using the PC5208 module
- Four High Current (1 Amp) PGM outputs Available Using the PC5204 module
- 1 PC5204 Output Fully Supervised for Siren Output

##### Powerful 1 Amp Regulated Power Supply:

- 500 mA Auxiliary Supply, 12 V<sub>DC</sub>
- Positive Temperature Coefficient (PTC) components replace fuses
- Supervision for loss of AC Power, Low Battery
- Internal Clock Locked to AC Power Frequency

##### Power Requirements:

- Transformer = 16.5 VAC, 40VA
- Battery = 12 volt 4 Ah minimum rechargeable sealed lead acid

##### Remote Keypad Specifications:

- 4 Different Keypads Available:
  - PC5508/KP5508/P832-08 8 Zone LED Keypad
  - PC5516/KP5516/P832-16 16 Zone LED Keypad
  - PC5532/KP5532/P832-32 32 Zone LED Keypad
  - LCD5500/KPL5500/P832-LCD Alphanumeric Keypad
- Each Keypad has 5 Fully Programmable Function Keys
- Connect up to 8 Keypads
- Four Wire (Quad) Connection to KEYBUS
- Built in Piezoelectric Buzzer

##### Digital Communicator Specifications:

- Supports all Major Formats including SIA and Contact ID
- Event Initiated Personal Paging
- 3 Programmable Phone Numbers
- 2 Account numbers
- Supports LINKS 1000 Cellular Communication
- DTMF and Pulse Dialing
- DPDT Line Seizure
- Anti-jam Feature
- Split Reporting of Selected Transmissions to Each Telephone Number

**System Supervision Features**

The PC5010 continuously monitors a number of possible trouble conditions including:

- AC Power Failure
- Fire Trouble
- Low Battery Condition
- Loss of Internal Clock
- Tamper by Zone
- Module Fault (Supervisory or Tamper)
- Trouble by Zone
- Telephone Line Trouble
- Bell Output Trouble
- AUX Power Supply Fault
- Failure to Communicate

**False Alarm Prevention Features**

- Audible Exit Delay
- Urgency on Entry Delay
- Swinger Shutdown
- Communication Delay
- Audible Exit Fault
- Quick Exit
- Recent Closing Transmission

**Additional Features**

- Auto Arm by Partition at Specified Time
- Keypad Activated Alarm Output and Communicator Test
- Keypad Lockout
- Audio Capability using the PC5908 Audio Interface Module which allows local intercom and Central Station 2-Way Listen in.
- All modules connect to the system via a four wire KEYBUS up to 1000'/330m from main panel
- Event Buffer can be printed using PC5400 RS232 Serial Interface module
- Zone Doubler Option
- Supports the ESCORT 5580 Voice Prompt Module with Automation/Lighting Control
- 128 Event Buffer, Time and Date Stamped
- Upload/Download Capability

**1.2 Additional Devices**

**1.2.1 Keypads**

A maximum of eight (8) keypads can be connected to the control panel and can be any combination of the following listed. Different keypads (with function keys) can be used for different size systems; 8 zone, 16 zone and 32 zone.

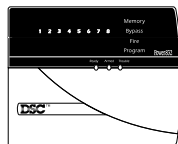

PC5508/KP5508/P832-08  
8 zone LED keypad

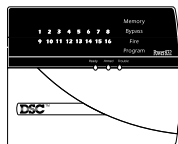

PC5516/KP5516/P832-16  
16 zone LED keypad

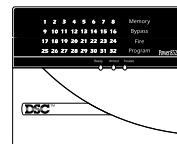

PC5532/KP5532/P832-32  
32 zone LED keypad

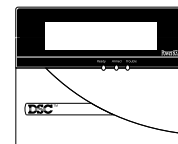

LCD5500/KPL5500/P832-LCD  
LCD keypad

**1.2.2 PC5108 Eight Zone Expander Module**

Eight zone expander module can be used to increase the number of zones on the system. Up to 3 modules can be connected to increase the system zones to a maximum of 32. (See *PC5108 Installation Instructions Sheet*.)

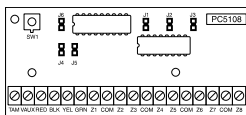

**1.2.4 PC5132-900 Wireless Receiver Module**

The PC5132-900 Wireless Receiver module can be used to connect up to 32 wireless devices. All devices are spread spectrum, 900 MHz, fully supervised and use standard 'AAA' or 'AA' alkaline batteries (See Section 5.27 "Wireless Expansion"). (See PC5132-900 Installation Manual.)

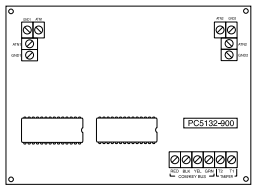

Additional devices are available:

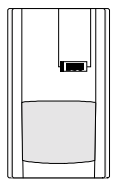

**WLS904**  
Wireless Motion Detector

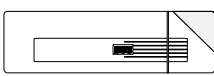

**WLS905**  
Wireless Universal Transmitter

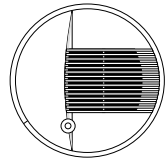

**WLS906**  
Wireless Smoke Detector

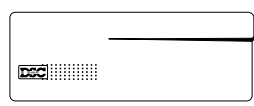

**WLS907**  
Wireless Slimline  
Universal Transmitter

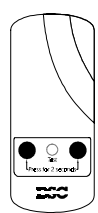

**WLS908**  
Wireless Panic Pendant

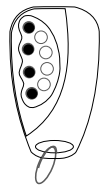

**WLS909**  
Wireless Key Fob

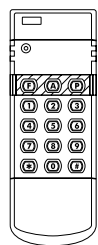

**WLS910**  
Wireless Handheld Keypad

**WLS904 Wireless Motion Detector**

The wireless Motion Detector can be used in conjunction with the PC5132-900 Wireless Receiver to include wireless space protection. The unit comes with four 'AAA' batteries.

**WLS905 Wireless Universal Transmitter**

The wireless Universal Transmitter can be used in conjunction with the PC5132-900 Wireless Receiver module to add wireless door or window contacts. The Universal Transmitter comes with three 'AAA' batteries and has built-in contacts. The unit also provides terminals for connecting hardwire contacts.

**WLS906 Wireless Smoke Detector**

The wireless Smoke Detector can be used in conjunction with the PC5132-900 Wireless Receiver to include wireless smoke detection. The unit comes with six 'AA' batteries.

**WLS907 Wireless Slimline Universal Transmitter (This device is not UL Listed)**

The wireless Slimline Universal Transmitter can be used with the PC5132-900 Wireless Receiver to add wireless door or window contacts in a smaller package. The unit comes with three 'AAA' batteries and has built-in contacts.

**WLS908 Wireless Panic Pendant (This device is not UL Listed)**

The wireless Panic Pendant can be used in conjunction with the PC5132-900 Wireless Receiver to include personal wireless protection. The unit comes with 1 mini 12V battery. It is a disposable transmitter in that it is Ultrasonically welded together and the battery is not user changeable.

**WLS909 Wireless Key Fob (This device is not UL Listed)**

The wireless Key Fob can be used in conjunction with the PC5132-900 Wireless Receiver to include a simple and mobile method of arming and disarming the system. The unit comes with three Photo/Electronic 1.5V batteries.

This system can have a maximum of 16 wireless Key Fobs.

**WLS910 Wireless Handheld Keypad (This device is not UL Listed)**

The wireless Handheld Keypad can be used in conjunction with the PC5132-900 Wireless Receiver to include a simple and mobile method of arming and disarming the system. The unit comes with three 'AAA' batteries.

The system can have a maximum of four wireless Handheld Keypads.

**1.2.5 PC5204 Power Supply Output Module**

The PC5204 can provide up to 1 Amp of additional power for modules or devices connected to the control panel. The module requires a 16.5 volt AC 40 VA transformer and 4 AH battery. In addition, the module provides 4 programmable high current voltage outputs. Each output is individually programmable with 14 different output options available (See Section 5.10 "PGM Outputs"). (See PC5204 Installation Instructions Sheet.)

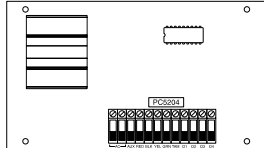

**1.2.6 PC5208 Eight Low Current Output Module**

Adds eight low current outputs (50 mA) to the control. Each output is individually programmable with 14 different output options available (See Section 5.10 "PGM Outputs"). (See PC5208 Installation Instructions Sheet.)

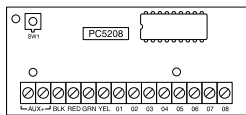

**1.2.7 ESCORT5580 Module**

This ESCORT5580 module will turn any touch tone phone into a fully functional keypad. The module also includes a built-in interface to control up to 32 line carrier type devices for lighting and temperature control (See Section 5.28 "ESCORT5580 Module"). (See ESCORT5580 Installation Manual.)

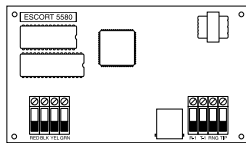

**1.2.8 PC5908 Audio Interface Module (This device is not UL Listed)**

The PC5908 Audio Interface module is a simple way to incorporate paging, intercom, baby listen-in and door answer to the PC5010 control panel. The module also has built-in two-way voice capability for central station (See Section 5.30 "Audio Interface Module").

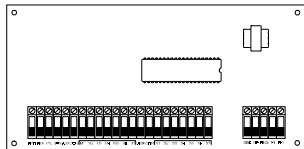

Three additional devices are available:

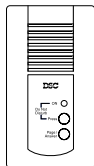

**PC5901**  
Intercom Audio Station

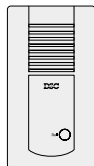

**PC5901 EXT**  
Door Box Audio Station

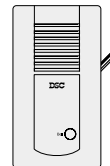

**PC5901 EXT/R**  
Door Box Audio Station

**PC5901 Intercom Audio Station (This device is not UL Listed)**

The PC5901 Intercom Audio Station can be used in conjunction with the PC5908 Audio Interface Module.

**PC5901 EXT Door Box Audio Station (This device is not UL Listed)**

The PC5901 EXT Door Box Audio Station can be used in conjunction with the PC5908 Audio Interface Module.

**PC5901 EXT/R Door Box Audio Station (This device is not UL Listed)**

The PC5901 EXT/R Door Box Audio Station can be used in conjunction with the PC5908 Audio Interface Module. The Door Box contains a relay so the normal door bell can be used instead of the internal one generated by the PC5908 module.

**1.2.9 PC5400 Printer Module**

This PC5400 Printer Module will allow the panel to print out all events that occur on the system to any serial printer. All events will be printed with the Partition, time, date and the event that occurred (See Section 5.29 "On-site Printer").

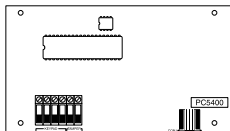

**1.2.10 LINKS 1000 Cellular Communicator (This device is not UL Listed)**

The LINKS 1000 Cellular Communicator provides an efficient, cost-effective method for adding cellular back up. The unit comes in its own cabinet with antenna and requires a separate battery and transformer (See Section 5.26 "LINKS 1000 cellular communicator").

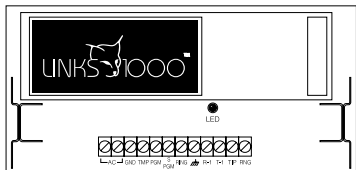

**1.2.11 Cabinets**

Several different cabinets are available for the PC5010 modules. They are as follows:

**PC5003C Cabinet**

Main control cabinet for the PC5010 main panel. Dimensions 288mm x 298mm x 78mm / 11.3" x 11.7" x 3" approximately.

**PC5002C Cabinet**

Cabinet to house the PC5204 Power Supply Output Module. Dimensions 213mm x 235mm x 78mm / 8.4" x 9.25" x 3" approximately.

**PC5004C Cabinet**

Cabinet to house the PC5580 ESCORT Module and PC5400 Printer Module. Dimensions 229mm x 178mm x 65mm / 9" x 7" x 2.6" approximately.

**PC5001C Cabinet**

Cabinet to house the PC5108 Zone Expander Module, the PC5108D Zone Doubler Expander Module and the PC5208 Eight Low Current Output Module. Dimensions 153mm x 122mm x 38mm / 6" x 4.8" x 1.5" approximately.

**PC5001CP Cabinet**

Plastic cabinet to house the PC5108 Zone Expander Module, the PC5108D Zone Doubler Expander Module and the PC5208 Eight Low Current Output Module. Dimensions 146mm x 105mm x 25.5mm / 5.75" x 4.2" x 1" approximately.

**1.2.12 Backplates**

There are two different backplates available for keypads to locate an Audio Station next to the keypad:

**PC55BP1 Backplate**

This backplate is to be used when an Audio Station is to be located next to a keypad. Dimensions 208mm x 115mm x 18mm / 8.2" x 4.5" x 0.25" approximately.

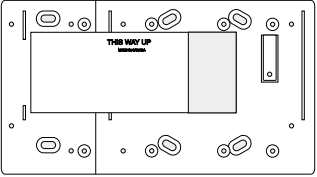

**PC55BP2 Backplate**

This backplate is to be used when an Audio Station is to be located next to a keypad. In addition the backplate will allow you to mount a PC5108 Zone Expander Module, the PC5108D Zone Doubler Expander Module or the PC5208 Eight Low Current Output Module. Dimensions 208mm x 115mm x 18mm / 8.2" x 4.5" x 0.7" approximately.

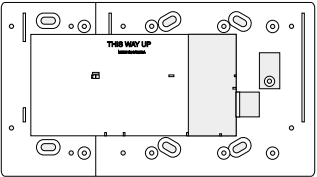

**1.3 Out of the Box**

You should find the following equipment included in your system. Verify each of the components is included:

- one PC5010 main control cabinet
- one PC5010 main control circuit board
- one PC55XX (8 zone, 16 zone or 32 zone LED)/LCD5500 keypad
- one Installation Manual
- one Programming Worksheet Manual
- one End User manual (LED or LCD keypad)
- one hardware pack consisting of:
  - five plastic circuit board standoffs
  - sixteen 5600 ohm (5.6K) resistors
  - seventeen 2200 ohm (2.2K) resistors
  - one 1000 ohm (1K) resistor

# Getting Started

## S E C T I O N 2

The following sections provide a complete description of how to wire and configure devices and zones.

### 2.1 Installation Steps

The following steps are provided to assist with the installation of the panel. It is suggested that you read over this section briefly to get an overall understanding of the order of installation. Once this is done carefully work through each step. Working from this plan will help reduce problems and reduce the overall installation time required.

#### Step 1 Create a Layout

Draw a rough sketch of the building and include all alarm detection devices, zone expanders, keypads and all other modules that are required.

#### Step 2 Mounting the Panel

Locate the panel in a dry area, preferably located near an unswitched AC power source and the incoming telephone line. **Before attaching the cabinet to the wall be sure to press the five circuit board mounting studs into the cabinet from the back.**



**Complete all wiring before applying AC or connecting the battery.**

#### Step 3 Wiring the KEYBUS (Section 2.3)

Wire the KEYBUS to each of the modules following the guidelines provided.

#### Step 4 Assigning Zones to Zone Expanders (Section 2.5)

If zone expander modules are being used the modules must be configured so the panel knows which zones are assigned to each expander. Follow the guideline provided to assign zones to expanders.

#### Step 5 Zone Wiring (Section 2.9)

Power down the control panel and complete all zone wiring. Follow the guidelines provided in Section 2.9 to connect zones using normally closed loops, single EOL resistor, double EOL resistors, zone doubler, Fire zones and Keyswitch Arming zones.

#### Step 6 Completing Wiring

Complete all other wiring including bells or sirens, phone line connections, ground connections or any other wiring necessary. Follow the guidelines provided in Section 2.2 "Terminal Descriptions".

#### Step 7 Power up the Control

Once all zone wiring and KEYBUS wiring is complete, power up the control panel.



**The panel will not power up if only the battery is connected.**

#### Step 8 Keypad Assignment (Section 2.6)

Keypads must be assigned to different slots to be properly supervised. Follow the guideline provided in Section 2.6 to assign keypads.

#### Step 9 Enabling Supervision (Section 2.7)

After all modules have been wired to the KEYBUS, supervision must be enabled. Once supervision is enabled, the panel will be able to indicate module communication faults. Follow the guidelines provided in Section 2.7.

#### Step 10 Programming the System (Sections 4 and 5)

Section 4.0 provides a complete description of how to program the panel. Section 5.0 contains complete descriptions of the various programmable features, what options are available and how the options function. The Programming Work Sheets should be filled out completely before attempting to program the system.

#### Step 11 Testing the System

Test the panel completely to ensure that all features and functions are operating as programmed.

### 2.2 Terminal Descriptions

#### AC Terminals - AC

The panel requires a 16.5 volt, 40 VA transformer. Connect the transformer to an unswitched AC source and connect the transformer to these terminals.



**Do not connect the transformer until all other wiring is complete.**

#### Battery Connection

The battery is used to provide back up power in the event of an AC power failure and to provide additional current when the panel demands exceed the power output of the transformer, such as when the panel is in alarm.

**! Do not connect the battery until all other wiring is complete.**

Connect the RED battery lead to the positive of the battery, the BLACK battery lead to the negative.

**Auxiliary Power Terminals - AUX+ and GND**

These terminals provide up to 500 mA of additional current at 12 V<sub>DC</sub> (**rated 11.6 - 12.6 Vdc for UL residential applications**) for devices requiring power. Connect the positive side of any device requiring power to the AUX+ terminal, the negative side to GND. The AUX output is protected; if too much current is drawn from these terminals (wiring short) the panel will temporarily shut off the output, until the problem is corrected.

**Bell Output Terminals - BELL+ and BELL-**

These terminals provide up to 3 Amps of current at 12 V<sub>DC</sub> (**rated 11.6 - 12.6 Vdc for UL residential applications**) (with stand-by battery; 700 mA continuous) for powering bells, sirens, strobes or other warning type equipment. Connect the positive side of any alarm warning device to BELL+, the negative side to BELL-. The BELL output is protected; if too much current is drawn from these terminals (wiring short) the BELL fuse will open.

The Bell output is supervised. If no alarm warning device is being used connect a 1000 ohm resistor across BELL+ and BELL- to prevent the panel from displaying a trouble condition (See Section 3.4 “[\*] Commands, [\*][2]”).

**KEYBUS Terminals - RED, BLK, YEL, GRN**

The KEYBUS is used by the panel to communicate with modules and by modules to communicate with the panel. Each module has four KEYBUS terminals that must be connected to the four KEYBUS terminals on the panel. For more information, see Section 2.3 “KEYBUS Operation and Wiring”.

**Programmable Outputs - PGM1 and PGM2**

Each PGM output is an open collector switch to ground. That is, when the PGM output is activated by the panel the terminal will switch to ground.

PGM1 can sink up to 50 mA of current to activate LEDs or a small buzzer. Connect the positive side of the LED or buzzer to AUX+, the negative side to PGM1. If more than 50 mA of current is required a relay must be used. Refer to the following diagram:

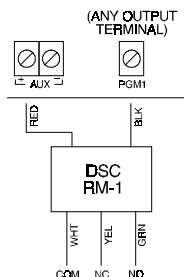

PGM2 operates similar to PGM1.

**Zone Input Terminals - Z1 to Z8**

Each detection device must be connected to a zone on the control. It is suggested that each zone have one detection device however it is possible to wire multiple detection devices to the same zone. For zone wiring specifics, see Section 2.9 “Zone Wiring”.

**Telephone Connection Terminals - TIP, RING, T-1, R-1**

If a telephone line is required for central station communication or downloading connect an RJ-31X jack in the following manner:

- RING - Red Wire ..... Incoming line from telephone company
- TIP - Green Wire ..... Incoming line from telephone company
- R-1 - Grey Wire ..... Outgoing line to house telephone(s)
- T-1 - Brown Wire ..... Outgoing line to house telephone(s)

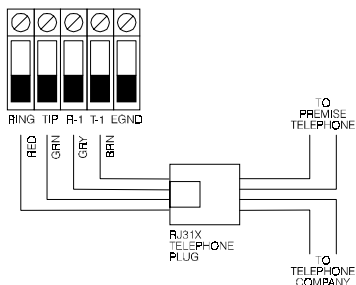



**!** *Ensure the plugs and jacks meet the dimension, tolerance and metallic plating requirements of 47 C.F.R. Part 68, SubPart F. For proper operation there must be no other telephone equipment connected between the control panel and the telephone company facilities. Do not connect the alarm panel communicator to telephone lines intended for use with a FAX machine. These lines may incorporate a voice filter which disconnects the line if anything other than FAX signals are detected, resulting in incomplete transmissions.*

### 2.3 KEYBUS Operation and Wiring

The KEYBUS is used by the panel to communicate with all modules connected and by the modules to talk to the panel. The RED and BLK terminals are used to provide power while YEL and GRN are clock and data.

**!** *The 4 KEYBUS terminals of the panel must be connected to the 4 KEYBUS terminals or wires of all modules.*

The following conditions apply:

- KEYBUS should be run in minimum 22 gauge quad (0.5mm), two pair twist preferred
- the modules can be home run to the panel, connected in series or can be T-tapped
- any module can be connected anywhere along the KEYBUS, you do not need a separate KEYBUS wire run for keypads, zone expanders etc.
- no module can be more than 1,000'/330m (in wire length) from the panel
- shielded wire is not necessary unless wires are run in an area that may present excessive RF noise or interference

#### Example of KEYBUS Wiring

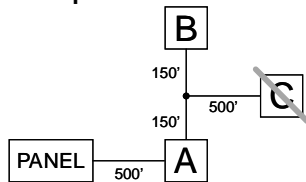

NOTE: Module (A) is wired correctly as it is within 1,000'/330m of the panel, in wire distance.  
 Module (B) is wired correctly as it is within 1,000'/330m of the panel, in wire distance.  
 Module (C) is NOT wired correctly as it is further than 1,000'/330m from the panel, in wire distance.

### 2.4 Current Ratings - Modules and Accessories

In order for the PC5010 system to operate properly, the power output capabilities of the main control and expansion devices must not be exceeded. Use the data presented below to ensure that no part of the system is overloaded and cannot function properly.

#### System Outputs (all 12 Vdc)

- PC5010
  - VAUX: 500 mA. Includes one keypad. Subtract for each additional keypad, expansion module and accessory connected to VAUX or KEYBUS.
  - BELL: 700 mA. Continuous Rating.
  - 3.0 A. Short Term. Available only with stand-by battery connected.
- PC5204
  - VAUX: 1.0 A. Continuous Rating. Subtract for each device connected.
  - 3.0 A. Short Term. Available only with stand-by battery connected.
- PC5208
  - VAUX: 250 mA. Subtract for each device connected. Subtract the total load on this terminal from the PC5010 VAUX/KEYBUS output.
- PC5108
  - VAUX: 100 mA. Subtract for each device connected. Subtract the total load on this terminal from the PC5010 VAUX/KEYBUS output.

#### PC5010 Device Ratings (@ 12 Vdc)

- LCD5500 Keypad: 50 mA
- PC5532 Keypad: 45 mA
- PC5516 Keypad: 45 mA
- PC5508 Keypad: 45 mA
- PC5108 Zone Module: 35 mA
- PC5108D Zone Doubler Module: 35 mA
- PC5204 Output Module: 20 mA
- PC5208 Output Module: 50 mA
- PC5132-900 Wireless Module: 125 mA
- ESCORT5580 Module: 150 mA
- PC5908 Audio Interface Module: 65 mA
- PC5901 Intercom Audio Station: 20 mA
- PC5901 EXT Door Box Audio Station: 20 mA
- PC5901 EXT/R Door Box Audio Station: 35 mA
- PC5400 Printer Module: 62 mA

**Other Devices**

Read the manufacturer's literature carefully to determine the maximum current requirement (during activation or alarm) and use this value for loading calculations. Do not allow connected devices to exceed the system capabilities during any possible operational mode.

**2.5 Assigning Zones to Zone Expanders**

The main panel contains zones 1 to 8. Additional zone expanders may be added to increase the number of zones on the system. Each zone expander consists of two groups of 4 zones and each group must be configured to assign the specific zones to the expander. This is done by setting the jumpers located on the expander to the proper settings.

**!** *Before a zone expander will work properly the jumpers must be set so the panel can determine the correct zone assignment.*

The following are the jumper settings for different zone assignments:

Expander Zones	Jumpers			System Zones Assigned
Group A (Zones 1-4)	J1	J2	J3	
Group B (Zones 5-8)	J4	J5	J6	
	ON	ON	ON	Zones not enabled for hardware operation
	OFF	ON	ON	Zones not enabled for hardware operation
	ON	OFF	ON	Zones 9 - 12
	OFF	OFF	ON	Zones 13 - 16
	ON	ON	OFF	Zones 17 - 20
	OFF	ON	OFF	Zones 21 - 24
	ON	OFF	OFF	Zones 25 - 28
	OFF	OFF	OFF	Zones 29 - 32

The following is a diagram of the zone expander and where the jumper switches are located.

**!** *There are two sets of jumpers, one set for the first 4 zones of the expander and one set for the other 4 zones.*

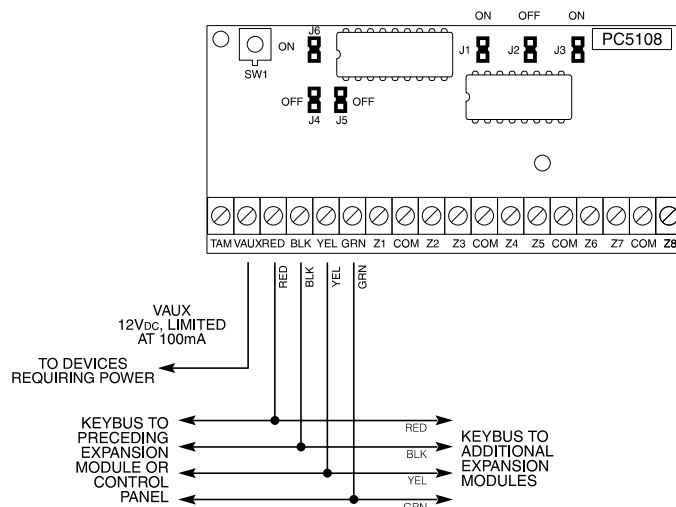

In the above diagram the jumper settings shown indicate the first group of four zones of the expander will be zones 9 to 12 and the second group of 4 zones will be 13 to 16. A group of zones can be disabled if they are not required for the installation.

**2.6 Keypad Assignment**

There are 8 available slots for keypads. LED keypads by default are always assigned to slot 1 while the LCD5500 is always assigned to slot 8. Keypads can each be assigned to a different slot (1 to 8) which offers two advantages. The panel can supervise the keypad connection to indicate a trouble condition if it is removed. Also keypads can be assigned to operate a specific partition or operate as a global keypad.

**2.6.1 How to Assign Keypads**

**!** *All keypad assignment must be done individually on each keypad on the system.*

To assign a keypad to a slot and select the partition it will operate, enter the following:

Step 1 — Enter Installer Programming

Step 2 — Press [000] for Keypad Programming

Step 3 — Press [0] for Partition and Slot Assignment

Enter a two digit number to specify the partition and slot assignment.

1st digit Enter 0 for Global Keypad;  
           Enter 1 for Partition 1 Keypad;  
           Enter 2 for Partition 2 Keypad

2nd digit Enter 1 to 8 for Slot Assignment

Press the [#] key twice to exit programming. Continue this procedure at each keypad until all have been assigned to the correct slot.

**2.6.2 How to Program Function Keys**

Each of the 5 Function Keys on each keypad may be programmed for different operation on each keypad.

- Step 1 - Enter Installer Programming.
- Step 2 - Press [000] for Keypad Programming.
- Step 3 - Enter [1] to [5] to select Function Key to program.
- Step 4 - Enter the 2 digit number, [00] to [17] for option.
- Step 5 - Continue from Step 3 until all Function Keys are programmed.
- Step 6 - Press [#] to exit Installer Programming.

For a complete list of Function Key options See Section 3.5.1 "Function Key Options".

**2.7 Enable Supervision**

Once all the KEYBUS connections have been made, supervision must be enabled so the panel can indicate a trouble if a module is removed from the system.

To enable supervision, enter the following at any keypad:

- Step 1 - Press [\*] [8] [Installer Code] to enter Installer Programming.
- Step 2 - Press [902] to enable supervision. The panel will automatically search for all modules on the system. Once the search (it will take about 1 minute) is complete enter the following to confirm the modules on the system.
- Step 3 - Press [903] to display all modules.

Zone lights will be turned on according to what modules the panel has found on the system. The LCD keypad will allow you to scroll through the modules. Refer to the following chart:

Light [1] ..... Keypad 1 present	Light [13] ..... Zones 25 to 28 present
Light [2] ..... Keypad 2 present	Light [14] ..... Zones 29 to 32 present
Light [3] ..... Keypad 3 present	Light [15] ..... N/A (not used)
Light [4] ..... Keypad 4 present	Light [16] ..... N/A (not used)
Light [5] ..... Keypad 5 present	Light [17] ..... Module PC5132-900 present
Light [6] ..... Keypad 6 present	Light [18] ..... Module PC5208 present
Light [7] ..... Keypad 7 present	Light [19] ..... Module PC5204 present
Light [8] ..... Keypad 8 present	Light [20] ..... Module PC5400 present
Light [9] ..... Zones 9 to 12 present	Light [21] ..... Module PC5908 present
Light [10] ..... Zones 13 to 16 present	Light [22] ..... N/A
Light [11] ..... Zones 17 to 20 present	Light [23] ..... N/A
Light [12] ..... Zones 21 to 24 present	Light [24] ..... ESCORT5580 module present

If a module is connected but does not show as being present, it may be due to any of the following reasons:

- it is not connected to the KEYBUS
- if there is a KEYBUS wiring problem
- if the module is more than 1,000'/330m from the panel
- if the module does not have enough power
- if the PC5132-900 does not have any devices added

**2.8 Removing Modules**

If a module is no longer required on the system the panel must be told to no longer supervise the module. To do this remove the module from the KEYBUS and perform the Enable supervision function again (See Section 2.7 "Enable Supervision"). The panel will see the module has been removed and will no longer supervise it.

**2.9 Zone Wiring**

There are several different ways in which zones may be wired, depending on the programming options selected.

**!** *Any zone defined as Fire, 24 Hour Links Supervisory and Links Answer (See Section 5.1 “Zone Definitions”) will automatically require a single End of Line (EOL) resistor regardless of which type of zone wiring supervision is selected. When reconfiguring the zone supervision from a non-default setting, such as DEOL to EOL/NC to DEOL/disabling zones 1-8 while open or in trouble, the system should be powered down completely and powered up again.*

**2.9.1 Normally Closed (NC) Loops**

Wire all zones according to the following diagrams:

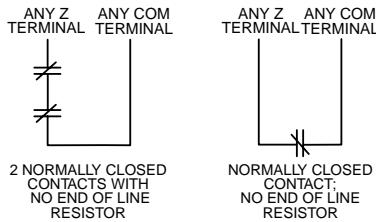

**!** *This option can only be selected if Normally Closed (NC) detection devices or contacts are being used.*

**2.9.2 Single End Of Line (EOL) Resistors**

Wire all zones according to the following diagrams:

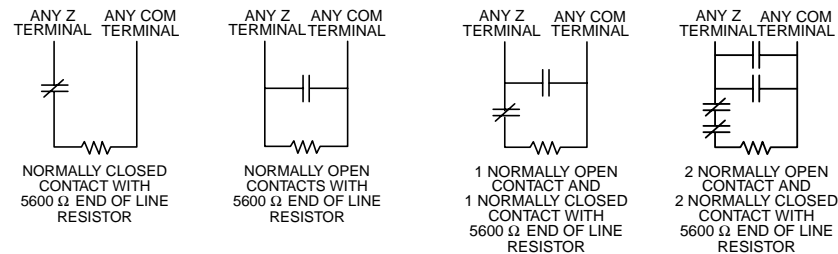

**!** *This option can be selected if either Normally Closed (NC) or Normally Open (NO) detection devices or contacts are being used.*

**2.9.3 Double End of Line (DEOL) Resistors**

Double EOL loops allow the panel to determine if the zone is in alarm, tampered or faulted. Wire the zones according to the following diagram:

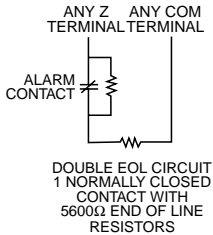

**!** *This option can only be selected if Normally Closed (NC) detection devices or contacts are being used. Only one NC contact can be connected to each zone, multiple detection devices or contacts on one loop is not allowed.*

The following chart shows the status of the zone under certain conditions:

Loop Resistance .....	Loop Status
5600Ω (contact closed) .....	Secure
11200Ω (contact open) .....	Violated
0Ω (shorted wire, loop shorted) .....	Fault
Infinite (broken wire, loop open) .....	Tamper

**2.9.4 Fire Zone Wiring - 4 wire Smoke Detectors**

All zones defined as Fire (See Section 5.1 "Zone Definitions") must be wired according to the following diagram:

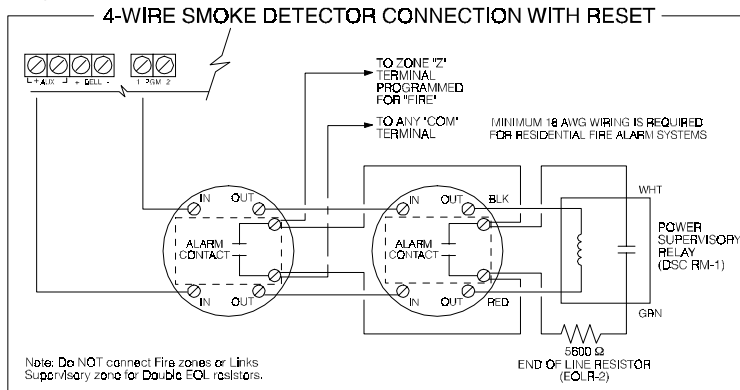

For a complete description of how fire zones operate, see Section 5.1 "Zone Definitions".

**2.9.5 Fire Zone Wiring - 2 wire Smoke Detectors**

If PGM2 has been programmed for 2 Wire Smoke Detector connection (See Section 5.10 "PGM Output"), the detectors must be wired according to the following diagram:

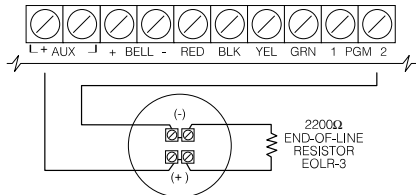

For a complete description of how fire zones operate, see Section 5.1 "Zone Definitions".

**! If PGM2 is programmed for 2 wire smoke support, Jumper J1 on the main board must be removed.**

**2.9.6 Keyswitch Zone Wiring**

Zones may be programmed to be used as keyswitch arming zones and must be wired according to the following diagrams:

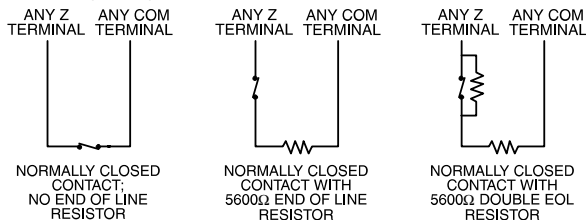

For a complete description of how keyswitch zones operate, see Section 5.1 "Zone Definitions".

**2.9.7 LINKS Supervisory (Shall not be used on UL Listed systems)**

If the LINKS 1000 cellular communicator is being used a zone may be configured for LINKS Supervisory (See Section 5.1 "Zone Definitions"). If the LINKS 1000 experiences a trouble it will violate the zone, causing the panel to report the event to central station.

The zone programmed as LINKS Supervisory ALWAYS requires a single EOL resistor (5.6K) and must be wired according to the following diagram:

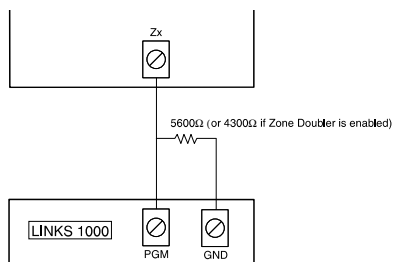

**2.9.8 LINKS Answer (Shall not be used on UL Listed systems)**

If the LINKS 1000 cellular communicator is being used a zone may be configured for LINKS Answer to allow downloading to be performed in the event of phone line failure.

When the LINKS receives a phone call it will activate the RING terminal on the LINKS circuit board. This terminal can be used to violate a zone programmed as LINKS Answer (See Section 5.1 "Zone Definitions"), causing the panel to seize the phone line and begin communication with the downloading computer.

The zone programmed as LINKS Answer ALWAYS requires a single EOL resistor (5.6K) and must be wired according to the following diagram:

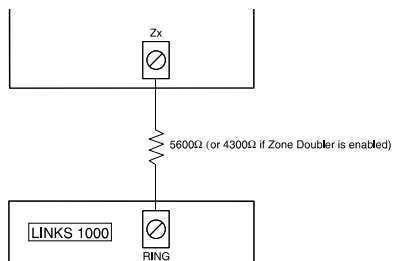

# Keypad Commands

## S E C T I O N 3

All keypads provide complete information and control of the alarm panel. The panel can be completely programmed via any keypad on the system. LED keypads provide function indicator lights and individual zone indicator lights for the alarm circuits. The LCD keypad provides function indicator lights and word descriptions for zone status.

The following sections describe how to arm, disarm and perform other keypad functions.

### 3.1 Access Codes

The panel has a total of 37 Access Codes available.

- Access Codes [01] to [32] .. User Codes 1 to 32
- Access Code [33] ..... Partition 1 Duress Code
- Access Code [34] ..... Partition 2 Duress Code
- Access Code [40] ..... System Master Code
- Access Code [41] ..... Partition 1 Master Code
- Access Code [42] ..... Partition 2 Master Code

#### System Master Code

The **System Master Code Not Changeable** option can be used to lock in the code. This will prevent the user from being able to change the System Master Code. If they attempt to change the code the keypad will sound a long error beep. The System Master Code can be used to arm or disarm any partition and perform any keypad function.

If the code is lost it can be reprogrammed through Installer Programming.

.....

System Master Code Not Changeable ..... Section [015], Option [6]

System Master Code ..... Section [007]

.....

#### Partition Master Codes

By default the Partition Master Codes are not programmed. They must be programmed by the System Master Code. A Partition Master, once programmed, can be used to arm and disarm the Partition it is assigned to. In addition, a Partition Master can program the 32 User Codes to operate on the Partition it is assigned to and program the Partition Duress Code.

#### Partition Duress Codes

By default Partition Duress Codes are not programmed. They must be programmed by the System Master Code or the Partition Master Code for that Partition. Once programmed if the Duress Code is used any time, the panel will activate a silent Duress alarm (See Section 5.7 "Communicator - Reporting Codes").

#### User Codes

By default the 32 User Codes are not programmed. They must be programmed by the System Master Code or Partition Master Code. Once programmed the User Code can be used to arm or disarm any Partition it is enabled for. In addition, each User Code can be enabled or disabled for bypass ability (See Section 3.4 "[\*] Commands, [\*] [1] Zone Bypass") and for accessing the system by the ESCORT5580.

#### Maintenance Code

The Maintenance Code is an access code that can only arm/disarm the panel. It cannot be used to bypass zones. This code cannot be used to access the system by the ESCORT5580. The code can be used for service personnel.

.....

Maintenance Code ..... Section [008]

.....

### 3.2 Arming /Disarming

The system cannot be armed unless the 'Ready' light is on. If the 'Ready' light is not on make sure all protected doors and windows are secure and stop movement in areas covered by motion detectors. When the 'Ready' light is on enter any valid Access Code. As each digit is pressed the keypad will beep. If an incorrect code is entered the keypad will emit a steady 2 second beep to indicate the code was not correct. If the code is correct but the 'Ready' light was not on the panel will beep six times rapidly followed by a long two second beep to indicate the system was not Ready. When the correct code is entered and the system is Ready the panel will beep six times rapidly and the 'Armed' light will turn on. Exit the premises through the designated entry/exit door. Other methods of arming are available (See Section 3.4 "[\*] Commands - [\*] [0] Quick Arm, [\*] [9] Arming Without Entry Delay" and Section 3.5 "Function Keys").

**!** *The PC5010 has a built-in feature called Audible Exit Fault. See Section 5.15 “Entry/Exit Delay Options for more information.*

To disarm the panel enter the premises through the designated entry/exit door. The keypad will emit a steady beep to warn that you must disarm the system. During the last 10 seconds of entry delay the panel will pulse the keypad beeper on and off rapidly to warn the entry delay is about to expire. Enter a valid Access Code at the keypad. If an error is made press the [#] key and enter the code again. When a correct code is entered the keypad will turn off the ‘Armed’ light and stop the keypad buzzer. If an alarm occurred while the panel was armed the ‘Memory’ light and the zones which caused the alarm will be flashing. Press the [#] key to return the keypad to the Ready state.

**3.3 Auto Bypass (Shall not be used on UL Listed systems)**

When the system is armed and any zone or zone(s) on the system have been programmed as Stay/Away the panel will immediately turn on the ‘Bypass’ light. It will then monitor all zones programmed as Delay 1 and Delay 2. If no delay type zone is violated by the end of the exit delay the panel will bypass all Stay/Away type zones. The ‘Bypass’ light will remain on to inform the home owner that the interior protection has been automatically bypassed by the panel. If a delay zone is violated during the exit delay, the Stay/Away zones will be active after the exit delay expires.

This is a convenience for the user that wishes to arm the panel while at home. The user does not have to bypass the interior manually.

The user can add the Stay/Away zones back into the system at any time by entering the [\*] [1] keypad command (See Section 3.4 “[\*] Commands, [\*][1] Zone Bypass”).

Other methods of Stay arming are available (See Section 3.5 “Function Keys”).

**3.4 [\*] Commands**

**[\*]+[1] Zone Bypass/Reactivate Stay/Away Zones**

The [\*] [1] keypad command can be used to bypass individual zones. It can be used if the user wants to have access to an area while the Partition is armed or to bypass a defective zone (bad contact, damaged wiring) until service can be provided.

A Partition can be armed with a bypassed zone. A bypassed zone will not cause an alarm.

If **Code Required for Bypass (required for UL Listed systems)** is enabled an access code will be required to enter the Bypass mode. Only user codes with the Bypass attribute enabled will be able to bypass zones (See Section 3.4 “[\*] Commands, [\*] [5]”).

**!** *Zones can only be bypassed when the partition is disarmed.*

**To bypass a zone:**

1. Enter [\*] [1] (access code if required).
2. The keypad will flash the ‘Bypass’ light and turn on the zone lights for any zones already bypassed.
3. Enter the 2 digit zone number to bypass the zone.
4. The keypad will turn on the zone light.
5. Press [#].

All zones that were lit when the [#] key was pressed are now bypassed. The ‘Bypass’ light will be on steady to indicate zones are bypassed.

**To un-bypass a zone:**

1. Enter [\*] [1] (access code if required).
2. The keypad will flash the ‘Bypass’ light and turn on the zone lights for any zones already bypassed.
3. Enter the 2 digit zone number to un-bypass the zone.
4. The keypad will turn off the zone light.
5. Press [#].

All zones that were lit when the [#] key was pressed are now bypassed. If no zones were lit, the ‘Bypass’ light will be off and no zones will be bypassed.

**!** *When a Partition is disarmed all manually bypassed zones will be un-bypassed.*

**Reactivate Interior**

If a Partition is armed in the Stay mode (See Section 3.2 “Arming/Disarming”), the [\*] [1] command can be used to reactivate the Stay/Away zones.

**!** *Please ensure all force-armed zones are restored before reactivating the Stay/Away zones.*

.....  
 Code required for bypass - section [015], option [5]  
 .....



**[\*]+[2] Trouble Display**

The panel constantly monitors itself for several different trouble conditions. If a trouble condition is present the 'Trouble' light will be on steady and all keypads will beep twice every 10 seconds.



***The trouble beep can be silenced by pressing any key on any keypad.***

**To view trouble conditions:**

1. Press [\*] [2].
2. The keypad will flash the 'Trouble' light and light zones to indicate which trouble conditions are present. A description of the various troubles are as follows:

**Trouble [1] - Service Required**

This light will be on if any of the following trouble conditions are detected by the control panel; Low Battery, Bell Circuit Trouble, General System Trouble, General System Tamper, General System Supervisory, PC5204 Low Battery and PC5204 AC Failure.

If a 'Service Required' trouble is present press [1] to determine the specific trouble present. The following is a list of the specific 'Service Required' trouble conditions:

- Light [1] - Low Battery  
The main panel backup battery is low. The trouble will be generated if the battery drops below 11.5 volts under load and will restore when the battery charges over 11.8 volts.
- Light [2] - Bell Circuit Trouble  
The panel will indicate this trouble if the Bell fuse is blown or the panel senses an open condition on the bell circuit (*See Section 5.12 "Siren Supervision"*).
- Light [3] - General System Trouble  
This trouble will be present if the PC5204 Power Supply module has an AUX failure, PC5204 Output #1 Trouble, or a printer connected to the PC5400 Printer module has a fault (off-line).
- Light [4] - General System Tamper  
This trouble will be indicated if a Tamper Zone violation on any module is detected.
- Light [5] - General System Supervisory  
This trouble will be indicated if the panel loses communication with any module connected to the KEYBUS (*See Section 2.7 "Enable Supervision"*). The event buffer will log a detailed description of the event.
- Light [6] - Not Used
- Light [7] - PC5204 Low Battery  
The PC5204 module has a low backup battery.
- Light [8] - PC5204 AC Failure  
The PC5204 module has lost AC power.

**Trouble [2] - AC Failure**

This trouble indicates that AC power is no longer being supplied to the control unit. If it is required to communicate this to a monitoring station, program reporting codes in sections [349] and [350]. To inhibit reporting of short duration power outages, a delay can be programmed in section [370].

**Trouble [3] - Telephone Line Trouble**

The telephone connection to the control unit is continuously monitored. If there is a problem with the telephone connection, a trouble will be indicated after the delay programmed in section [370]. If the system has a LINKS 1000, this trouble can be reported to a monitoring station by programming reporting codes in sections [349] and [350].

**Trouble [4] - Failure to Communicate (FTC)**

If the communicator fails in an attempt to communicate with any of the programmed telephone numbers, this trouble will be generated. If a later attempt is successful, the FTC reporting code(s) programmed in section [351] will be transmitted along with any other unreported events that occurred while the panel was not able to communicate.

**Trouble [5] - Zone Fault (including Fire Zone)**

This trouble will be indicated if any zone on the system is in a trouble condition, i.e. it could not provide an alarm to the panel if required to do so. When a trouble condition occurs, the keypad(s) on the affected partition will start to beep.

Press [5], while in Trouble mode, to view which zones have a trouble condition. If 2-wire smoke detectors are being used, a trouble on that zone will be indicated by the "Fire" LED.

**Trouble [6] - Zone Tamper**

This trouble is only generated by zones configured for Double End-of-Line Resistor Supervision. This trouble is generated when a tamper condition is present. When a tamper condition occurs, the keypad(s) on the affected partition will start to beep.

Press [6], while in Trouble mode, to view which zones have a tamper condition.

**Trouble [7] - Zone Low Battery**

This trouble is generated when an RF device reports a low battery condition to the control unit. Press [7] while in Trouble mode to view which RF zones have a low battery.

**Trouble [8] - Loss of System Time**

This trouble occurs when the control unit is powered up and the internal clock has not been set. Setting the time with User Function [\*][6][Master Code][1] will clear this trouble.

[\*]+[3]

**Alarm Memory**

The 'Memory' light will be on if any alarm occurred during the last armed period or if an alarm occurred while the panel was disarmed (24 hour zones).

**To view alarm memory:**

1. Press [\*] [3].
2. The keypad will flash the Memory light and light up zone lights to indicate alarm or tamper conditions that occurred during or since the last armed period. When the panel is armed the 'Memory' light will go out.

[\*]+[4]

**Door Chime On/Off**

If enabled the keypad will beep 5 times rapidly when a zone is tripped and restored. The panel will only do this for zones with the Door Chime attribute enabled and if the door chime feature is enabled (See Section 5.2 "Zone Attributes").

**To turn Door Chime on/off:**

1. Press [\*] [4].
2. The keypad will beep 3 times rapidly when the Door Chime feature is enabled and one long beep when the feature is disabled.

[\*]+[5]

**Programming Access Codes**

There are 37 Access Codes available. They are as follows:

- Access Code [01] to [32] . User Codes 1 to 32
- Access Code [33] ..... Partition 1 Duress Code
- Access Code [34] ..... Partition 2 Duress Code
- Access Code [40] ..... Master Code
- Access Code [41] ..... Partition 1 Master Code
- Access Code [42] ..... Partition 2 Master Code

All Access Codes have the ability to arm/disarm any Partition(s) it is enabled for and activate the PGM Outputs using the [\*][7][Access Code][1] and [\*][7][2] commands (See Section 3.4 "[\*] Commands, [\*][7]").

Additional Access Code Attributes are also programmable. Attributes determine what abilities the code will have. The programmable attributes are as follows:

- Partition 1 Operation enable
- Partition 2 Operation enable
- Zone Bypass enable

**User Codes - Access Codes [01] to [32]**

Each User Code can be programmed to work on Partition 1, Partition 2 or both Partitions. In addition each can be programmed to have the ability to bypass zones.



***"Master Code" attributes cannot change. By default, each code has the attributes of the code used to program it.***

**Duress Codes - Access Codes [33] and [34]**

When a Duress Code is used to perform any function the panel will report a Duress Reporting Code (See Section 5.7 "Communicator - Reporting Codes").

**Partition Master Codes - Access Codes [41] and [42]**

Partition Master Codes can program additional User Codes and the Duress Code for their Partition.

**System Master Code - Access Code [40]**

By default the System Master Code is enabled to operate on both Partitions and can perform any keypad function. This code can be used to program all User Codes as well as the Partition Master Codes and Duress Codes.

If the **Master Code Not Changeable** option is enabled the System Master Code can only be changed using Installer Programming.

**How to program Access Codes:**

Programming Access Codes is a two step process. First the Code must be programmed followed by the Code Attributes.

1. Enter [\*] [5] [Master Code]. The keypad will flash the 'Program' light and turn on the zone light for any code already programmed.
2. Enter the 2 digit number for the code you want to program. The corresponding zone light will flash.
3. Enter a 4 digit code. The zone light will turn on steady.
4. Continue with steps 2 and 3 until all codes are programmed.



**Do not press [\*] or [#] when programming the 4 digit code. When programming Duress Codes or Partition Master Codes no zone light will flash.**

After all the Codes have been programmed press the [#] key to return to the Ready mode.

**How to program Access Code Attributes:**



**"Master Code" attributes cannot change. By default, each code has the attributes of the code used to program it.**

1. Enter [\*][5][Master Code]. The keypad will flash the 'Program' light and turn on the zone light for any code already programmed.
2. Press [9] to enter the Attribute mode. The keypad will turn on the 'Ready' light and turn off the armed light.
3. Enter the 2 digit number for the code you want to program Attributes for. Zone lights [1] to [4] will be on or off. Refer to the following chart:
  - Zone Light 1 - ON - enable code for Partition 1
  - Zone Light 2 - ON - enable code for Partition 2
  - Zone Light 3 - ON - enable Zone Bypass
4. Enter [1] to [3] to turn the zone lights ON or OFF, then press [#] key.
5. Continue with steps 2 and 3 until all code attributes are programmed.

After all the codes and attributes have been programmed press the [#] key to exit Access Code Programming.

**How to erase Access Code:**

Select the code to be erased and press [\*].

**[\*]+[6] User Functions**

This keypad command can be used to program several different functions. The following are the items programmable:

- [1] - Time and Date
- [2] - Auto-Arm Enable \*
- [3] - Auto-Arm Time \*
- [4] - System Test
- [5] - Enable DLS (Downloading)
- [6] - Enable background music
- [7] - For future use

Auto-Arm items (noted with the "\*" symbol) are programmable by Partition. These must be programmed at a keypad assigned to the correct Partition (See Section 2.6 "Keypad Assignment").

**To program User Functions:**

1. Press [\*] [6] [Master Code]. The keypad will flash the 'Program' light.
2. Press the number [1] to [5] for the item to be programmed.

- [1] - Time and Date

The time and date must be accurate for the Auto-Arm or Test Transmission functions to work properly. In addition the event buffer time and date stamps all events.

- Enter the time: hour and minute, using military format [HH MM]. (00:00 to 23:59)
- Enter the date: month, day and year [MM DD YY].



**All entries must be 2 digits. January, for example, would be month [01].**

- [2] - Auto-Arm Enable/Disable (**Shall not be enabled on UL Listed systems**)

Auto-Arming will not work until it is enabled for the Partition.

Press [2]. If the keypad beeps 3 times rapidly Auto-Arm is enabled, one long beep means it is disabled.

- [3] - Auto-Arm Time

Each Partition can be programmed to Auto-Arm at a different time.

Enter the time, hour and minute, using military format [HH MM].



**All entries must be 2 digits. Eight o'clock in the morning would be [08] hours and [00] minutes.**

- [4] - System Test  
When [4] is pressed the panel will perform the following:
  - sound the alarm output for two seconds
  - light all lights on the keypad
  - sound the keypad buzzer for two seconds
  - test the main panel/PC5204 battery
  - send a System Test Reporting code, if programmed (See Section 5.7 “Communicator - Reporting Codes”).
- [5] - Enable DLS (Downloading)  
When [5] is pressed the panel will turn on the downloading option for 6 hours. During this time the panel will answer incoming downloading calls (See Section 5.8 “Downloading”).
- [6] - For future use
- [7] - Enable Background Music  
If the intercom is being used to provide background music, press the [6] key to toggle the background music feature on and off.

---

**!** **Additional Features are available using on the LCD keypad. These features do not have numbers assigned. Use the arrow keys (<>) to scroll through the [\*] [6] menu and press the [\*] key to select the following commands.**

---

**View Event Buffer**

The 128 Event Buffer can be viewed through any LCD keypad (See Section 5.16.1 “Viewing the Event Buffer Through the LCD Keypad”).

**Brightness Control**

When this option is selected the keypad will allow you to scroll through 10 different backlight level options. Use the arrow keys (<>) to scroll to the desired backlight level and press the [#] key to exit.

**Contrast Control**

When this option is selected the keypad will allow you to scroll through 10 different contrast level options. Use the arrow keys (<>) to scroll to the desired contrast level and press the [#] key to exit.

**Keypad Buzzer Control**

When this option is selected the keypad will allow you to scroll through 21 different keypad sounder tone options. Use the arrow keys (<>) to scroll to the desired keypad beeper level and press the [#] key to exit. This function can be achieved on LED keypads by holding the [\*] key.

**[\*]+[7] Output Functions**

Two Output Functions can be performed at a keypad. They are Utility Output and Smoke Detector Reset.

**To activate Utility Output:**

Press [\*] [7] [1][Access Code].

The panel will activate all PGM Outputs for 5 seconds programmed as Utility Output for that Partition (See Section 5.10 “PGM Outputs”).

**To activate Smoke Detector Reset:**

Press [\*] [7] [2].

The panel will activate all PGM Outputs for 5 seconds programmed as Sensor Reset. This command will also reset two wire smoke detectors connected to PGM2 programmed as Two Wire Smoke Support (See Section 5.10 “PGM Outputs”).

**[\*]+[8] Installer Programming**

Enter [\*][8] followed by the Installer Code to enter Installer Programming (See Section 4.0 “How to Program”).

**[\*]+[9] Arming Without Entry Delay**

When a Partition is armed with the [\*][9] command the panel will remove the entry delay from the partition. After the exit delay, Delay 1 and Delay 2 type zones will be instant and Stay/Away zones will remain bypassed. (See Section 5.1 “Zone Definitions”).

A valid access code must be entered after pressing [\*] [9].

**[\*]+[0] Quick Arm/Quick Exit**

**Quick Arm**

If the Quick Arm Enable option is enabled the panel can be armed by entering [\*][0]. This is a useful method of arming a Partition when someone without a User Code will be required to arm a Partition.

**Quick Exit**

Quick Exit will allow someone to leave an armed premise through a Delay type zone without having to disarm and rearm the system.

When [\*][0] is entered, if the Quick Exit Enabled option is enabled, the panel will provide a two minute window to exit. During this time the panel will ignore the first activation of a Delay type zone. When the Delay zone is secured the panel will end the two minute time period.

If a second Delay zone is tripped, or if the zone is not restored after two minutes, the panel will start entry delay.

**!** *If Quick Exit is used on a partitioned system, Keypad Blanking and Access Code Required to Remove Blanking should be enabled.*

---

Code Required for Bypass ..... Section [015], Option [5]  
 Master Code Not Changeable option ..... Section [015], Option [6]  
 Quick Arm Enable ..... Section [015], Option [4]  
 Quick Exit Enable ..... Section [015], Option [3]

### 3.5 Function Keys

There are 5 function keys on the PC5010 keypads labelled Stay, Away, Chime, Reset and Exit. The operation of these keys is described below. The function is activated by pressing and holding the key for 2 seconds.

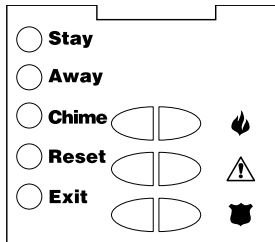

**“Stay” - Stay Arm**

Arms the partition to which the keypad is assigned. All Stay/Away type zones will be automatically bypassed. Delay type zones will provide entry and exit delay. The Quick Arm feature must be enabled for this key to function.

**“Away” - Away Arm**

Arms the partition to which the keypad is assigned. All Stay/Away type zones will be active at the end of the exit delay. Delay type zones will provide entry and exit delay. The Quick Arm feature must be enabled for this key to function.

**“Chime” - Door Chime On/Off**

Pressing the key will toggle the Door Chime feature ON or OFF. One solid beep means the feature has been disabled, three short beeps means it has been enabled.

**“Reset” - Reset Smoke Detectors**

Pressing this key will cause the panel to activate for 5 seconds any output programmed as Sensor Reset. In addition two wire smoke detectors connected to PGM2 will also be reset (See Section 3.4 “[\*] Commands, [\*][7][2]”).

**“Exit” - Activate Quick Exit**

Pressing this key will cause the panel to activate the Quick Exit feature (See Section 3.4 “[\*] Commands, [\*][0]”).

#### 3.5.1 Function Key Options

The following is a list of Function Key options available:

**[00] - Null Key**

The key is not used and will perform no function when pressed.

**[01] - Select Partition 1**

Provides an easy way to select Partition 1 operation from a Partition 2 keypad. This is the same as pressing and holding the [#] key then pressing and holding the [1] key to select Partition 1 from a Partition 2 keypad (See Section 3.6 “Global and Partition Keypad Operation”).

**[02] - Select Partition 2**

Provides an easy way to select Partition 2 operation from a Partition 1 keypad. This is the same as pressing and holding the [#] key then pressing and holding the [2] key to select Partition 2 from a Partition 1 keypad (See Section 3.6 “Global and Partition Keypad Operation”).

**[03] - Stay Arm**

Same as described in Function Keys - Section 3.5.

**[04] - Away Arm**

Same as described in Function Keys - Section 3.5.

**[05] - [\*]+[9] No-Entry Delay Arm**

After this function key is pressed the user must enter a valid user code. The Partition will arm and remove entry delay from the partition when the exit delay expires (See Section 3.4 "[\*] Commands, [\*] [9] Arming without entry delay").

**[06] - [\*]+[4] Door Chime On/Off**

This function key provides the user a simple method for turning the Door Chime feature on and off (See Section 3.4 "[\*] Commands, [\*] [4] Door chime on/off").

**[07] - [\*]+[6]...[4] System Test**

This function key provides the user with a simple method for testing the system (See Section 3.4 "[\*] Commands, [\*] [6] User functions").

**[08] - [\*]+[1] Bypass Mode**

This function key provides the user with a simple method for entering the Bypass Mode. If a user code is required it must be entered before bypassing can be performed (See Section 3.4 "[\*] Commands, [\*] [1] Zone Bypass").

**[09] - [\*]+[2] Trouble Display**

This function key provides the user with a simple method for entering the Trouble Display Mode (See Section 3.4 "[\*] Commands, [\*]+[2] Trouble display").

**[10] - [\*]+[3] Alarm Memory**

This function key provides the user with a simple method for entering the Alarm Memory Display Mode (See Section 3.4 "[\*] Commands, [\*] [3] Alarm memory").

**[11] - [\*]+[5] Programming Access Codes**

This function key provides the user with a simple method for programming user codes. After this key is pressed a valid System Master or Partition Master will have to be entered before the panel will allow programming to be performed (See Section 3.4 "[\*] Commands, [\*] [5] Programming Access Codes").

**[12] - [\*]+[6] User Functions**

This function key provides the user with a simple method for programming User Functions. After this key is pressed a valid System Master or Partition Master must be entered before the panel will allow User Functions to be performed (See Section 3.4 "[\*] Commands, [\*] [6] User functions").

**[13] - [\*]+[7]+[1] Utility Output**

This function keys provides the user with a simple method for activating a PGM Output programmed as Utility Output (See Section 5.10 "PGM outputs"). After this key is pressed a valid user code must be entered (See Section 3.4 "[\*] Commands, [\*] [7] Utility output functions").

**[14] - [\*]+[7]+[2] Smoke Detector Reset**

Same as described in Function Keys - Section 3.5.

**[15] - General Voice Prompt Help**

For use with a LED keypad, if both the ESCORT5580 and the PC5908 intercom module are being used, audio help can be provided by programming one of the function keys as option [15]. When the function key is pressed, the intercom will perform a Help page. The user must then press the Page/Answer button on the intercom station to terminate the help session. For more information, please refer to the PC5908 Installation Manual.

**[16] - [\*]+[0] Quick Exit**

Same as described in Function Keys - Section 3.5.

**[17] - [\*]+[1] Reactivate Stay/Away Zones**

This function key provides the user with a simple method for adding Stay/Away zones back into the system at night-time (See Section 3.4 "[\*] Commands, [\*] [1] Reactivate Stay/Away zones").

**[18] Identified Voice Prompt Help**

For use with a LCD keypad, this feature operates similar to option [15] except that the ESCORT will begin to announce status of the system through the intercom station closest to the keypad. In order for this option to operate correctly, you must program which intercom station is closest to each keypad in the PC5908 programming sections. For more information, please refer to the PC5908 Installation Manual.

**3.6 Global and Partition Keypad Operation**

A global keypad will not display any information (the trouble LED will light if a trouble condition is present) until a partition is selected. To select a partition the user must press and hold the [1] key for Partition 1 or the [2] key for Partition 2 for two seconds. The keypad will then display the status of the selected partition and allow normal operation.

A Partition keypad will display the status of the Partition for which it has been programmed. A user with access to both partitions may temporarily assign the keypad to the other partition to gain access. To do this the user must first press and hold the [#] key for two seconds. The keypad will go blank. The user must then press and hold the [1] key for Partition 1 or the [2] key for Partition 2 for two seconds. The keypad will then display the status of the selected partition and allow normal access.

# How to Program

## S E C T I O N 4

The following section of the manual describes how to enter Installer Programming and how to program the various sections.

**!** *It is extremely important that you read the following section of the manual to completely understand how to program the panel.*

### 4.1 How to Enter Installer Programming

Installer Programming is used to program all communicator and panel options. The **Installer Code** is [5010] at default but may be changed to prevent unauthorized access to programming.

#### LED Keypad

**Step 1** From any keypad enter [\*][8][Installer Code].

- The 'Program' light will flash to indicate you are in programming
- The 'Armed' light will turn on to indicate the panel is waiting for the 3 digit Section number to program

**Step 2** Enter the 3 digit Section number you want to program.

- The Armed light will turn off
- The Ready light will turn on to indicate the panel is ready for the information for the selected Section

**!** *If the 3 digit section number entered is not valid or the module that pertains to the Section is not present the keypad will sound a 2 second beep or error tone.*

#### LCD Keypad

**Step 1** From any keypad enter [\*][8][Installer Code].

The Keypad will display 'Enter Section' followed by three dashes.

**Step 2** Enter the 3 digit Section number you want to program.

The keypad will now display information for the section entered.

.....  
Installer Code ..... Section [006]  
.....

### 4.2 Programming Decimal Data

When the Ready light is ON the panel is waiting for the information to be programmed for the selected Section. Enter the information written in the boxes for the Section found in the Programming Worksheets. If a digit is entered for each program box in a Section the panel will automatically exit from the Section. It will turn OFF the Ready light and turn the Armed light back ON.

You can also press the [#] key to exit a Section before entering data for every box. This is handy if you only need to change the first few program boxes. All other locations in the Section will remain unchanged. If the [#] key is pressed the panel will turn OFF the Ready light, turn ON the Armed light and exit you from the Section.

### 4.3 Programming HEX Data

On occasion, hexadecimal (HEX) digits may be required. To program a HEX digit press the [\*] key. The panel will enter HEX programming and Ready light will begin to flash.

The following table indicates which number should be pressed to enter the corresponding HEX digit:

1 = A    2 = B    3 = C    4 = D    5 = E    6 = F

After the correct HEX digit is entered the Ready light will continue to flash. If another HEX digit is required press the corresponding number. If a decimal digit is required press the [\*] key again. The Ready light will turn on solid and the panel will return to regular decimal programming.

**!** *It is important to watch the Ready light. If the light is flashing any number you enter will be programmed as the HEX equivalent.*

Example: To enter 'C1' for a closing by user 1, you would enter [\*] [3] [\*], [1]

[\*] to enter Hexadecimal mode (Ready light flashes)

[3] to enter C

[\*] to return to decimal mode (Ready light is solid)

[1] to enter digit 1

If you enter information into a section and make a mistake, press the [#] key to exit the section. Select that section again and re-enter the information correctly.

If you are using a pulse format, a decimal zero [0] does not transmit. Programming a zero [0] tells the panel not to send any pulses for that digit. Decimal zero [0] is a filler digit. To make a zero [0] transmit, it must be programmed as a Hexadecimal 'A'.

Example: for the three digit account number '403', you would enter [4], [\*] [1] [\*] [3], [0].

[4] to enter the digit 4

[\*] to enter Hexadecimal mode (Ready light flashes)

[1] to enter A

[\*] to return to decimal mode (Ready light is solid)

[3] to enter the digit 3

[0] to enter the digit 0 as a filler digit.

#### **4.4 Programming Toggle Option Sections**

Some Sections contain several toggle options. The panel will use zone lights 1 through 8 to indicate if the different options are enabled or disabled. Refer to the Programming Worksheets to determine what each option represents and whether the light should be ON or OFF for your application.

Press the number corresponding to the option to toggle the light ON or OFF.

Once all the toggle options have been selected correctly press the [#] key to exit the Section and save the changes. The panel will turn off the Ready light and turn on the Armed light.

#### **4.5 Viewing Programming**

##### **4.5.1 LED Keypads**

Any program Section can be viewed through the keypad. When a Section is entered the keypad will immediately display the first digit of information programmed in that Section.

The keypad displays the information using a binary format where:

Zone Light 1 = 1

Zone Light 2 = 2

Zone Light 3 = 4

Zone Light 4 = 8

Add up the values for the zone lights to determine the number displayed (for example, no zone lights = 0, all 4 zone lights = 15 HEX 'F').

Press any of the Emergency Keys (Fire, Auxiliary or Panic) to advance to the next digit. When all the digits in a Section have been viewed the panel will exit the Section, turn off the Ready Light, turn on the Armed light and wait for the next three digit Section number to be entered. If the [#] key is pressed the panel will also exit the Section.

##### **4.5.2 LCD Keypad**

Any program section can be viewed through the keypad. Depending on the section entered, the LCD will display the information differently as below:

Sections Entered	LCD Display
Phone number .....	Entire phone number
Partition identifier code .....	Entire partition identifier code
Toggle option .....	Entire section (all options)
Reporting code .....	Each 2-digit reporting code at a time

Use the arrow keys (<>) to scroll through the data being displayed.

Scroll past the end of the data displayed or press the [#] key to exit the Section.



# Program Descriptions

## S E C T I O N 5

The following section explains all the programmable features including how the feature operates, options that pertain to the feature and a summary of program locations that require programming.

### 5.1 Zone Definitions

These sections will allow you to select how each of the 32 zones will operate. Each zone requires a 2 digit entry.



***In addition to selecting how each zone will operate, attributes may be programmed by zone (See Section 5.2 "Zone Attributes").***

#### [00] Null Zone

The zone will not operate in any way. Zones that are not used should be programmed as Null zones.

#### [01] Delay 1 Zone

If this zone is violated when the panel is armed it will provide entry delay. The keypad buzzer will sound to warn the user that the system must be disarmed. If the panel is not disarmed before the entry delay expires an alarm will be generated. Typically this type of zone will be used for the front door, back door or any other entry/exit point. Refer to Section [005], "System Times", to program the Delay 1 zone entry delay time.

#### [02] Delay 2 Zone

This zone type operates the same as the Delay 1 zone option but can provide a different entry delay. Typically this zone will be used for a garage door. Refer to Section [005], "System Times", to program the Delay 2 zone entry delay.

#### [03] Instant Zone

If this zone type is violated when the panel is armed it will cause an instant alarm. Typically this zone is used for windows, patio doors or other perimeter type zones.

#### [04] Interior Zone

If this type of zone is violated when the panel is armed it will provide entry if a delay type zone was violated first. Otherwise it will cause an instant alarm. Typically this zone is used for interior protection devices, such as motion detectors.

#### [05] Interior Stay/Away Zone

This zone type works the same as the Interior zone type with one exception. The zone will be automatically bypassed under the following conditions:

- the panel is armed in the Stay Mode (See Section 3.5 "Function Keys")
- the panel is armed without entry delay (See Section 3.4 "[\*] Commands, [\*] [9]")
- the panel is armed and during the exit delay a Delay type zone is NOT tripped

The automatic bypass avoids having the user manually bypass interior type zones when arming at home. If automatically bypassed, the user can reactivate the zones by entering the [\*][1] command (See Section 3.4 "[\*] Commands, [\*][1] Zone Bypass"). Typically this zone is used for interior protection devices, such as motion detectors. Stay/Away zones should not be programmed as global zones.

#### [06] Delay Stay/Away Zone

This zone type will operate the same as the Interior Stay/Away zone type except that it will always provide entry delay. Typically this zone is used for interior protection devices, such as motion detectors and will help prevent false alarms since it will always provide the user the entry delay time to turn off the panel. Stay/Away zones should not be programmed as global zones.

#### [07] Delayed 24 Hour Fire Zone

If this zone is violated the alarm output will immediately activate but the communicator will be delayed for 30 seconds. If during the 30 second delay the user presses any key on any keypad the alarm output and communicator will be delayed an additional 90 seconds, providing the user time to correct the problem. If after the 90 second delay the zone is still violated the process will begin again; the alarm output will be activated but the communication will be delayed 30 seconds...

If the user does not press a key, after 30 seconds the alarm output will latch and the panel will communicate. The alarm will sound for the Bell Cutoff time programmed in Section [005], "System Times" or can be programmed to sound until a valid code is entered, Section [014], "Second System Option Code, option [8]".



***If a second Fire type zone is violated or the Fire keys are pressed during the delay time the panel will latch the alarm output and communicate immediately.***

If a delayed Fire zone is violated it will be displayed on all keypads and can be delayed at any keypad. Typically this zone is used for latching smoke detectors.

- [08] Standard 24 Hour Fire Zone**  
When violated the panel will immediately latch the alarm output and communicate to central station. The alarm will sound for the Bell Cutoff time programmed in *Section [005], "System Times"* or can be programmed to sound until a valid code is entered, *Section [014], "Second System Option Code, option [8]"*.  
If a Fire zone is violated it will be displayed on all keypads. Typically this zone is used for pull stations.
- [09] 24 Hour Supervisory Zone (with LINKS)**  
If this zone is violated, whether armed or disarmed, the panel will report to the central station, and log the zone fault.
- [10] 24 Hour Supervisory Buzzer Zone**  
Whether armed or disarmed, when this zone type is violated the panel will immediately latch the keypad buzzer until a valid user code is entered and will communicate immediately to the central station.
- [11] 24 Hour Burglary Zone**  
If this zone is violated, whether armed or disarmed, the panel will immediately latch the alarm output and communicate to the central station. The alarm will sound for the Bell Cutoff time programmed in *Section [005] "System Times"* or until a valid user code is entered.
- [12]-[20]** The following zone definitions operate similar to the 24 Hour Burglary except for System Event output type and SIA identifier:
 

<b>[12] 24 Hour Holdup Zone</b>	<b>[15] 24 Hour Medical Zone</b>	<b>[18] 24 Hour Sprinkler Zone</b>
<b>[13] 24 Hour Gas Zone</b>	<b>[16] 24 Hour Panic Zone</b>	<b>[19] 24 Hour Water Flow Zone</b>
<b>[14] 24 Hour Heat Zone</b>	<b>[17] 24 Hour Emergency Zone</b>	<b>[20] 24 Hour Freezer Zone</b>

*(Non-medical emergency only)*
- [21] 24 Hour Latching Tamper**  
If this zone is violated the installer must enter Installer Programming before the panel will allow either Partition to be armed.
- [22] Momentary Keyswitch Arm Zone**  
Momentary violation of this zone will alternately arm/disarm the Partition the zone is assigned to. This zone type should not be programmed as global.
- [23] Maintained Keyswitch Arm Zone**  
When this zone is violated the Partition it is assigned to will disarm. When this zone is secured the Partition it is assigned to will arm. This zone type should not be programmed as global.  
**NOTE: Wireless zones should not be programmed as keyswitch zones.**
- [24] LINKS Answer Zone**  
If the LINKS 1000 cellular communicator is being used it is possible to perform downloading through the unit if the phone line is disconnected. If this is required connect the RING terminal of the LINKS 1000 to this zone. Refer to the LINKS 1000 Installation sheet for more information.

**5.2 Zone Attributes**

Each zone will operate according to the Zone Definition selected for it (*See Section 5.1 "Zone Definitions"*).

Additional zone attributes can be programmed to customize the operation of a zone for a specific application. The following attributes are programmable by zone:

---

**Attributes for Fire Zones should not be changed from default.**

---

- Audible/Silent**  
Determines whether the zone will activate the alarm output or will be silent.
- Pulsed/Steady**  
Determines if the alarm output will be steady or pulse on for 1 second and off for one second.
- Activate Chime**  
Determines if the zone will activate the chime feature (*See Section 3.4 "[\*] Commands, [\*] [4] Door Chime ON/OFF"*).
- Bypass Enable**  
Determines if the zone can be manually bypassed (*See Section 3.4 "[\*] Commands, [\*] [1] - Zone Bypass"*).

**Force Arm Enable (Shall not be enabled on UL Listed systems)**

Determines if the system can be armed with the zone violated. At the end of exit delay, if this type of zone is violated, it will be ignored by the panel. Once the zone is secured it will be added back into the system. This zone attribute is useful for a garage door. The customer can arm the system with the garage door open. Later when the customer closes the door it becomes part of the system.

**NOTE: 24-hour zones must not have Force Arm enabled.**

**Swinger Shutdown Enable (Shall not be enabled on UL Listed systems)**

Determines if the panel will shut down the communicator for the zone after the swinger limit is reached (See Section 5.17 "Swinger Shutdown").

**Transmission (TX) Delay Enable**

Determines if the panel will delay communicating the alarm reporting code to the central station (See Section 5.18 "Transmission Delay").

**Wireless Zone**

Determines if the zone is a wireless zone or a hardwired zone. Allows the panel to generate low battery trouble and zone supervisories.

.....

Zones 1 to 32 Attributes .....	Section [101] - [132]
Audible/Silent Alarm .....	Section [101] - [132], Option [1]
Pulsed/Steady Alarm .....	Section [101] - [132], Option [2]
Activate Chime .....	Section [101] - [132], Option [3]
Bypass Enable .....	Section [101] - [132], Option [4]
Force Arm Enable .....	Section [101] - [132], Option [5]
Swinger Shutdown Enable .....	Section [101] - [132], Option [6]
Transmission Delay Enable .....	Section [101] - [132], Option [7]

.....

**5.3 Communicator - Dialing**

If the **Communicator Disable** option is selected the panel will not attempt to call central station. If enabled the panel will attempt to call central station when an event occurs that has a valid reporting code programmed (See Section 5.7 "Communicator - Reporting Code").

**Communicator Call Direction** Options are used to select which phone number the panel will dial when an event occurs.

If **DTMF Dialing** is enabled the panel will dial using DTMF (touch tone). If **Switch to Pulse Dial** is enabled the panel will switch to pulse dialing on the 5th attempt to call the central station. If disabled the panel will always dial DTMF.

If **DTMF Dialing** is disabled the panel will always pulse dial.

The **Post Dial Wait for Handshake** determines the amount of time the panel will wait for a valid handshake from the receiver. If the panel does not hear the handshake it will consider the call a failed attempt, hang up and try again.

The **Maximum Dialing Attempts** determines the maximum number of attempts the panel will make to send a signal to the central station before indicating a Failure to Communicate (FTC) trouble condition. The 3rd Phone Number can be used to back up the 1st in this situation (See Section 5.4 "Communicator - Phone Numbers").

.....

Pulse Dialing .....	Section [380], Option [3]
Switch to Pulse Dial .....	Section [380], Option [4]
Post Dial Wait for Handshake .....	Section [161]
Maximum Dialing Attempts .....	Section [160]
Communicator Disable .....	Section [380], Option [1]
Communicator Call Direction Options .....	Section [361] to [368]

.....

**5.4 Communicator - Phone Numbers**

The panel can call 3 different phone numbers for communication to central station. The **1st Phone Number** is the primary number, the **2nd Phone Number** is the secondary number and the **3rd Phone Number** will back up the 1st phone number if enabled.

---

**!** *The 3rd Phone Number will NOT back up the 2nd Phone Number.*

---

If **Alternate Dial** is enabled the panel will alternate between the 1st and 3rd phone numbers when attempting to call the central station. If disabled the panel will only attempt to call the 3rd phone number after failing to communicate on the 1st phone number.

---

**!** *For Alternate Dial to work properly the 3rd Phone Number must be enabled.*

---

Phone numbers can be up to 32 digits which will allow you to add special digits if required. To program the phone number enter numbers 0 through 9 as required. The following is a list of HEX digits which can also be programmed and the function they perform:

- HEX (B) - simulates the [\*] key on a touch tone phone
- HEX (C) - simulates the [#] key on a touch tone phone
- HEX (D) - forces the panel to search for dial tone
- HEX (E) - forces the panel to pause for 2 seconds
- HEX (F) - end of phone number marker

.....

- 1st Phone Number ..... Section [301]
- 2nd Phone Number ..... Section [302]
- 3rd Phone Number ..... Section [303]
- 3rd Phone Number Enable ..... Section [380], Option [5]
- Alternate Dial ..... Section [380], Option [6]

.....

**5.5 Communicator - Account Numbers**

There are two **Partition Identifier Codes** (or Account Numbers) programmable, one for each Partition. The Account Number is used by central station to determine which panel is calling.

If the panel is programmed as two Partitions both Account Numbers must be programmed. The panel will report to the central station by Partition. For example, if an alarm occurs on a zone assigned to Partition 1 the panel will report using Partition 1 Account Number.

.....

- Partition 1 Identifier Code ..... Section [310]
- Partition 2 Identifier Code ..... Section [311]

.....

---

**!** *UL has only verified compatibility with the Sur-Gard SG-MLR2-DG.*

---

**5.6 Communicator - Reporting Formats**

Each central station phone number of the panel can be programmed to report using any one of the 4 formats available. A 20 BPS pulse format is supported in addition to Contact ID, SIA and a Pager format. The following is a description of each:

**5.6.1 Pulse Formats**

Depending on the pulse format selected the panel will communicate using the following:

- 3/1, 3/2, 4/1 or 4/2
- 1400 or 2300 Hz handshake
- 20 bits per second
- non-extended

**Additional Notes on Pulse Formats**

1. The digit '0' will send no pulses and is used as a filler.
2. When programming account numbers enter four digits.
3. When programming a three digit account number the fourth digit must be programmed as a plain '0' which will act as a filler digit.
4. If an account number has a '0' in it, substitute a HEX digit 'A' for the '0'.

Examples:

- 3 digit account number [123] - program [1230]
- 4 digit account number [4079] - program [4A79]
- 3 digit account number [502] - program [5A20]

5. When programming reporting codes two digits must be entered. If one digit reporting codes are to be used the second digit must be programmed as a '0'. If a '0' is to be transmitted substitute a HEX digit 'A' for the '0'.

Examples:

- 1 digit reporting code [3] - program [30]
- 2 digit reporting code [30] - program [3A]

6. To prevent the panel from reporting an event program the reporting code for the event as [00] or [FF].

.....

- Communicator Format Options ..... Section [360]

.....

5.6.2 Contact ID

Contact ID is a specialized format that will communicate information quickly using tones rather than pulses. In addition to sending information more quickly the format also allows more information to be sent. For example, rather than reporting an alarm zone 1 the Contact ID format can also report the type of alarm, such as Entry/Exit alarm zone 1.

To program Contact ID a two digit number from Appendix A must be entered for every event to be transmitted. The two digit number determines the type of alarm. The panel will automatically generate all other information, including the zone number.

**!** This communication format cannot be selected if Central Station Two-Way Voice is required.

Additional Notes on Contact ID

- 1.Account numbers must be four digits in length.
2.If the digit '0' is in the account number substitute the HEX digit 'A' for the '0'.
3.All reporting codes must be two digits in length.
4.If the digit '0' is in the reporting code substitute the HEX digit 'A' for the '0'.
5.To prevent the panel from reporting an event program the reporting code for the event as [00] or [FF]. Refer to Appendix A for a list of Contact ID Identifiers.

Communicator Format Options ..... Section [360]

5.6.3 SIA (Level 2)

SIA is a specialized format that will communicate information quickly using frequency shift keying (FSK) rather than pulses. The SIA format will automatically generate the type of signal being transmitted, such as Burglary, Fire, Panic etc. The two digit reporting code is used to identify the zone or user code number.

**!** If the SIA format is selected the panel can be programmed to automatically generate all zone and user codes numbers eliminating the need to program these items.

If the SIA Sends Automatic Reporting Codes option is enabled the panel will operate as follows:

- 1.If the reporting code for an event is programmed as [00] the panel will not attempt to call the central station.
2.If the reporting code for an event is programmed as anything from [01] to [FF] the panel will AUTOMATICALLY generate the zone or user code number.
3.Bypassed zones will always be identified when partial closing the system.
The Communicator Call Direction Options can be used to disable reporting of events such as Openings/Closings. Also, if all the Opening/Closing reporting codes were programmed as [00] the panel would not report.
If the SIA Sends Automatic Reporting Codes option is disabled the panel will operate as follows:
1.If the reporting code for an event is programmed as [00] or [FF] the panel will not attempt to call central station.
2.If the reporting code for an event is programmed as anything from [01] to [FE] the panel will send the programmed reporting code.
3.Bypassed zones will never be identified, regardless of reporting code for "partial closing". Refer to Appendix B for a list of SIA identifiers.

Communicator Format ..... Section [360]
SIA Sends Automatic Reporting Codes ..... Section [381], Option [3]
Communicator Call Direction Options ..... Section [361] to [368]
SIA Identifiers ..... Appendix B

5.6.4 Pager Format

The Communicator Format option for either phone number can be programmed for Pager Format. If an event occurs and the Communicator Call Direction options direct the call to a phone number with the Pager Format selected the panel will attempt to page.

When calling a pager extra digits will be required to make it work properly.

The following is a list of Hex digits and what function they perform:

- Hex [B] - simulates the [\*] key on a touch tone phone
Hex [C] - simulates the [#] key on a touch tone phone
Hex [D] - forces the panel to search for dial tone
Hex [E] - two second pause
Hex [F] - end of phone number marker

The panel will attempt to call the pager one time. After dialing the digits in the phone number the panel will send the account number and reporting code followed by the [#] key (Hex [C]).

The panel has no way of confirming if the pager was called successfully which means a failure to communicate trouble will never be generated.

NOTE: In order for proper operation it may be necessary to insert 3 or 4 pauses (Hex digits [E]) at the end of the phone number.

**!** *The Pager Format cannot be used with the LINKS 1000 cellular communicator.*

- Communicator Format Options ..... Section [360]
- Communicator Call Direction Options ..... Section [361] to [368]

**5.7 Communicator - Reporting Codes**

The panel can be programmed to report events to a central station. The panel will send the reporting code programmed for the event.

Reporting codes can be one or two digits and can use HEX digits (A through F). The following is a description of the different reporting codes that can be programmed and when the events will be reported to central station.

**5.7.1 Zone Alarm**

The panel will transmit the **Zone Alarm** Reporting Code for a zone when the zone goes into alarm. 24 hour type zones will go into alarm whether the panel is armed or disarmed and report to the central station. All other zone types will only go into alarm if the panel is armed.

**5.7.2 Zone Restoral**

If the **Restoral on Bell Timeout** option is selected the panel will send the **Zone Restoral** Reporting Code for the zone when the alarm output times out AND the zone is secure. If the zone is not secured when the alarm output times out the panel will send the restoral immediately after the zone is secured.

If the **Restoral on Bell Timeout** option is not selected the panel will immediately send the **Zone Restoral** Reporting Code when the zone is secured or when the panel is disarmed, regardless if the alarm output is active or not.

**!** *24 Hour type zones will report the restoral immediately after the zone is secured.*

**5.7.3 Closings**

The panel will transmit a **Closing** Reporting Code to indicate a Partition(s) is armed. A different reporting code can be transmitted for each User Code, Partition Master Code and System Master Code to identify who armed the Partition(s).

A **Partial Closing** Reporting Code will be transmitted if a Partition is armed with zones manually bypassed. The code will also be transmitted if a Partition Auto Arms with zone(s) in violation.

A **Special Closing** Reporting Code will be transmitted if the Partition(s) is armed using any of the following methods:

- Quick Arm
- Auto Arm
- Arming with the Maintenance Code
- Arming via the DLS Software
- Arming via keyswitch
- 'Away' Function Key arming
- 'Stay' Function Key arming

A **Closing by Duress Code** Reporting Code will be transmitted in addition to the Duress reporting code if a Partition(s) is armed using a Duress Code.

A **Recent Closing** Reporting Code will be transmitted if an alarm occurs within 2 minutes of the exit delay expiring.

**5.7.4 Openings**

The panel will transmit an **Opening** Reporting Code to indicate a Partition(s) has been disarmed. A different reporting code can be transmitted for each User Code, Partition Master Code and System Master Code to identify who disarmed the Partition(s).

A **Special Opening** Reporting Code will be transmitted if the Partition(s) is disarmed using any of the following methods:

- Disarming using the Maintenance Code
- Disarming via the DLS Software
- Disarming via keyswitch

An **Opening After Alarm** Reporting Code will be transmitted in addition to the opening when the Partition(s) is disarmed after an alarm has occurred.

An **Opening by Duress** Reporting Code will be transmitted in addition to the Duress reporting code if a Partition(s) is disarmed using a Duress Code.

**5.7.5 Tamper**

If the panel is programmed for Double EOL zones (See Section 2.9 "Zone Wiring") the panel will report a **Zone Tamper Alarm** Reporting Code if an open condition is present on a zone. A different reporting code can be programmed for each zone for identification. The **Zone Tamper Restoral** Reporting Code will be transmitted immediately when the tamper condition is restored.

A **General System Tamper** Reporting Code will be transmitted when the tamper zone on any module is violated. The **General System Tamper Restoral** Reporting Code will be transmitted when the tamper zone on the module is restored.

**5.7.6 Priority/Emergency**

The panel will transmit a **Keypad Fire Alarm** Reporting Code AND the **Keypad Fire Restoral** Reporting Code when the Fire Keys on any keypad is pressed for two seconds.

The panel will transmit a **Keypad Auxiliary Alarm** Reporting Code AND the **Keypad Auxiliary Restoral** Reporting Code when the Auxiliary Keys on any keypad is pressed for two seconds.

The panel will transmit a **Keypad Panic Alarm** Reporting Code AND the **Keypad Panic Restoral** Reporting Code when the Panic Keys on any keypad is pressed for two seconds.

The panel will transmit a **Duress** Reporting Code any time either Duress Code is entered at any keypad. If the panel is armed using the Duress Code the panel will also transmit a **Closing by Duress** Reporting Code or if the panel is disarmed it will also transmit an **Opening by Duress** Reporting Code.

If PGM2 is being used for two wire smoke detectors (*See Section 5.10 "PGM Outputs"*) the panel will send a **Two Wire Smoke Alarm** Reporting Code if a smoke detector goes into alarm. The panel will transmit the **Two Wire Smoke Alarm Restoral** Reporting Code when the zone is restored.

**5.7.7 Maintenance**

The panel will transmit a **Battery Trouble Alarm** Reporting Code when the backup battery drops below 11.5 Vdc. The **Battery Trouble Restoral** Reporting Code will not be transmitted until the battery has been charged over 12.5 Vdc.

To prevent the panel from transmitting an **AC Failure Trouble Alarm** Reporting Code during short power outages the panel will not send the signal unless AC power is lost for the amount of minutes programmed for the AC Failure Communication Delay. The **AC Failure Trouble Restoral** Reporting Code will be transmitted as soon as AC power is restored.

**NOTE: If AC failure communications delay is programmed as 000, AC failure transmission will be disabled.**

A **Bell Circuit Trouble Alarm** Reporting Code will be transmitted immediately if an open condition is measured on the Bell Output of the main panel. The **Bell Circuit Trouble Restoral** Reporting Code will be transmitted as soon as the problem is corrected.

A **Fire Trouble Alarm** Reporting Code will be transmitted immediately when an open condition is measured on any Fire type zone (*See Section 5.1 "Zone Definitions"*). The **Fire Trouble Restoral** Reporting Code will be transmitted as soon as the problem is corrected.

The **Auxiliary Power Supply Trouble Alarm** Reporting Code will be transmitted if the AUX output is shorted. The AUX output control incorporates a fuseless design. When excessive current is drawn the panel will automatically shut off the output. The panel will constantly check the AUX output and when the excessive current draw is removed the panel will reset the output and transmit an **Auxiliary Power Supply Trouble Restoral** Reporting Code.

A **TLM Trouble** Reporting Code can only be transmitted if a LINKS 1000 Cellular Communicator is being used (*See Section 5.26 "LINKS 1000 Cellular Communicator"*). The panel will only transmit the signal after the time programmed for the TLM Trouble Delay. The **TLM Restoral** Reporting Code will be transmitted within 10 seconds of the problem being corrected.

A **General System Trouble** Reporting Code will be transmitted if the panel detects any of the following on the PC5204 Power Supply/Output Module: AC Power Failure, Low Battery, AUX Output Trouble, Output #1 Supervisory trouble or the PC5400 is off-line. The **General System Trouble Restoral** Reporting Code will be transmitted when all of the listed problems are corrected.

A **General System Supervisory Trouble** Reporting Code will be transmitted if any module goes missing from the KEYBUS. If the module is a zone expander the panel will also transmit the **Zone Expander Supervisory Alarm Trouble** Reporting Code. The panel will send a **General System Supervisory Restoral** Reporting Code when the problem is corrected as well as a **Zone Expander Supervisory Restoral** Reporting Code if the module is a zone expander.

**5.7.8 Test Transmissions**

The panel can be programmed to transmit a **Periodic Test Transmission** Reporting Code (*See Section 5.13 "Test Transmissions"*), a **System Test** Reporting Code (*See Section 3.4 "[\*] Commands, [\*] [6]"*) or a **LINKS 1000 Test Transmission** Reporting Code (*See Section 5.26 "LINKS 1000 Cellular Communicator"*).

**5.7.9 Wireless Maintenance**

The panel will transmit a **General Zone Low Battery Alarm** Reporting Code if a low battery condition is indicated by a detector. The transmission of the trouble will be delayed by the number of days programmed for **Zone Low Battery Transmission Delay**. The **General Zone Low Battery Restoral** Reporting Code will be transmitted when the problem is corrected. The specific zone that caused the trouble will be stored to the Event Buffer.



**The restoral will not be transmitted until all detectors indicate a good battery condition.**

**5.7.10 Miscellaneous**

The panel will transmit the **Keypad Lockout** Reporting Code if the lockout is activated (See Section 5.22 "Keypad Lockout").

The **DLS Lead In** Reporting Code will only be transmitted if the **DLS Call Back** feature is being used (See Section 5.8 "Downloading"). Before the panel calls the computer back it will call central station and transmit the reporting code to indicate a download session is about to begin. After downloading is complete the panel will transmit a **DLS Lead Out** Reporting Code to indicate the download session is complete.

If the panel fails to transmit information to the central station it will display a failure to communicate trouble condition. The panel will transmit a **Phone Number 1 Failure to Communicate** Reporting Code or a **Phone Number 2 Failure to Communicate** Reporting Code the next time it calls the central station. The panel will transmit the old events, followed by the failure to communicate, followed by the new events. This will allow central station to determine which events are old or new.

If the Event Buffer is uploaded on a regular basis an **Event Buffer 75% Full** Reporting Code can be transmitted to warn the Buffer is almost full. This is also useful if the PC5400 Printer Module is being used.

..... Section [320] to [353]

**5.8 Downloading**

Downloading allows programming of the entire control panel via a computer, modem and telephone line. All functions and features, changes and status, such as trouble conditions and open zones can be viewed or programmed by downloading.

**!** *When power is applied to the panel downloading will be enabled for 6 hours. This will allow you to perform downloading without having to do any keypad programming.*

If the **Downloading Answer** option is enabled (or during the first 6 hours after power up) the panel will answer incoming calls for downloading provided the following conditions occur:

1. The panel hears one or two rings then misses a ring.
2. At this point the panel will start a timer.
3. If the panel hears another ring before the **Answering Machine Double Call Timer** expires it will answer on the first ring of the second call.

The panel will immediately go on line and begin the download process unless the **Call Back** option is enabled. If enabled, the panel and computer will both hang up. The panel will then call the **Download Computer Telephone Number** and wait for the computer to answer. Once the computer answers downloading will begin.

If **User Enable DLS Window** is enabled the user can turn the downloading feature on for 6 hours through the **[\*][6]** keypad command. After 6 hours the panel will not answer incoming calls unless Downloading Answer is enabled (See Section 3.4 "[\*] Commands, [\*][6] User Functions").

The **Download Access Code** and **Panel Identifier Code** are for security and proper identification. Both the panel and the computer file should have the same information programmed before attempting to download.

If the LINKS 1000 cellular communicator is being used it is possible to download through the LINKS if the phone line is disconnected. If Call Back is being used you may have to program the **LINKS 1000 Preamble** to have the panel call back the computer correctly.

**!** *For more information refer to the Download Manual included with the computer software.*

.....

Downloading Answer .....	Section [401], Option [1]
User Enable DLS Window .....	Section [401], Option [2]
Call Back .....	Section [401], Option [3]
Answering Machine Double Call Timer .....	Section [405]
Download Computer Telephone Number .....	Section [402]
Download Access Code .....	Section [403]
Panel Identifier .....	Section [404]
LINKS 1000 Preamble (Downloading) .....	Section [490]

.....



## 5.9 Partitions/Zone Assignment

A partition is a defined area which will operate independent of another area of the system. The panel can be divided into two partitions. For example, in an office/warehouse installation it may be necessary to limit warehouse employees from accessing the office and office employees from accessing the warehouse. Any zone can be assigned to either, or both partitions. Any Access Code can be assigned to work on either, or both partitions (See Section 3.4 “[\*] Commands, [\*][5] Programming Access Codes”).

**Common Zones** are zones assigned to both partitions. A common zone will only be armed when both partitions are armed and will be disarmed when either partition is disarmed.

Keypads can be assigned to work on either partition or can be assigned for Global operation (See Section 2.6 “Keypad Assignment”).

Each partition can be programmed to report using a different Account Number (See Section 5.5 “Communicator - Account Numbers”).

Some of the Programmable Output options are also selectable by Partition (See Section 5.10 “PGM Outputs”).

The **Partition 2 Enable** option must be programmed before Partition 2 will operate.

At default zones 1 through 8 are assigned to Partition 1. If additional zones are being used or the application requires two Partitions zones must be enabled to operate on the correct Partition.



**Zones programmed as Null must be removed from both Partitions (See Section 5.1 “Zone Definition).**

---

Partition 2 is Enabled .....	Section [201], Option [1]
Partition 1 Zone Assignments .....	Section [202] to [205]
Partition 2 Zone Assignments .....	Section [206] to [209]

## 5.10 PGM Outputs

There are 3 different types of Programmable Outputs available. They are listed as follows:

- PGM1 and PGM2 on the main board
- 8 low current outputs available with the PC5208 Output Module
- 4 high current outputs available with the PC5204 Power Supply/Output Module

Programming any of the PGM Outputs is a two step process. First an option from the below list must be selected for the PGM Output. Second the PGM Attributes must be selected. The following is a list of the PGM Output Options and PGM Attributes.

### 5.10.1 PGM Output Options

#### [01] Burglary and Fire Bell Output

The PGM output will activate when the alarm output is active and will turn off when the alarm output is silenced. If the alarm output is pulsing the PGM output will pulse as well. This output does not follow the pre-alert for delayed fire zones.

#### [02] Utility Output

The PGM output will activate for 5 seconds when the [\*][7][1][Access Code] command is entered (See Section 3.0 “Keypad Commands”).

#### [03] Sensor Reset

This option is used to reset power for latching smoke detectors.



**The output will normally be active, switched to ground.**

The output will deactivate for 5 seconds when the [\*][7][2] command is entered (See Section 3.0 “Keypad Commands”). The keypad buzzer will not sound for the 5 second period.

Refer to the hookup diagram in this manual for wiring instructions.

#### [04] Two-Wire Smoke Support (PGM2 Only!)

PGM2 may be used in conjunction with two-wire smoke detectors.



**PGM Output Attributes for PGM2 when used for two wire smoke detector support must remain at default, Attribute 1, 2 and 3 ON.  
Do not program any PGM output other than PGM2 for two-wire smoke detector support.**

Refer to the Hook-Up diagram in this manual for wiring instructions (See Section 2.9.5 “Fire Zone Wiring - 2-Wire Smoke Detectors”).

**[05] Partition/System Armed Status**

The PGM output will activate when the Partition or System is armed and deactivate when disarmed.

**[06] Ready Output**

The PGM output will activate when the Partition or System is ready to arm. The output will deactivate when the system is not secure or upon arming.

**[07] Keypad Buzzer Follow**

The PGM will activate when any of the following events occur and will remain active for as long as the keypad buzzer is active:

- Door Chime
- Entry Delay
- Audible Exit Delay
- Auto-Arm Prealert
- 24 Hour Supervisory Buzzer Zone

**[08] Courtesy Pulse**

Upon arming the PGM output will activate for the duration of the exit delay plus two minutes. Upon entry the PGM output will activate for the duration of the entry delay plus two minutes. Only one courtesy pulse output may be programmed on a system.

**[09] System Trouble**

The PGM output will activate when any of the selected trouble conditions are present. It will deactivate when all the selected trouble conditions are cleared.

The normal PGM attributes, programmed in Sections [141] to [154] is replaced with the following list for any output selected as System Trouble:

- Light [1] Service Required (battery, bell, general trouble, general tamper, general supervisory)
- Light [2] AC Failure
- Light [3] Telephone Line Trouble
- Light [4] Failure to Communicate
- Light [5] Fire Trouble / Zone Fault
- Light [6] Zone Tamper
- Light [7] Zone Low Battery
- Light [8] Loss of Clock

**[10] Latched System Event**

The PGM output will activate when any of the selected events occur. It will deactivate when an access code is entered.

The normal PGM attributes, programmed in Sections [141] to [154] is replaced with the following list for any output selected as Latched System Event:

- Light [1] Burglary ..... Delay, Instant, Interior, Stay/Away and 24 Hour Burglary Zones
- Light [2] Fire ..... Fire Keys, Fire Zone and Two Wire Smoke Zone (PGM Output)
- Light [3] Panic ..... Panic Keys and Panic Zone
- Light [4] Medical ..... Auxiliary Keys, Medical and Emergency Zones
- Light [5] Supervisory ... Supervisory, Freezer and Water Zones
- Light [6] Priority ..... Gas, Heat, Sprinkler and 24 Hour Latching Zones
- Light [7] Holdup ..... Holdup Zones and Duress Alarms
- Light [8] Not Used

**[11] System Tamper**

The PGM Output will activate when any Tamper condition is present and will deactivate when all Tamper conditions are cleared.

**[12] TLM and Alarm**

The PGM Output will activate when a telephone line fault condition is present AND an alarm occurs. The PGM Output will remain active until an access code is entered. The output will activate for both audible and silent alarms if a TLM trouble is present.



***This output will activate for all audible and silent alarms except Duress.***

**[13] Kissoff**

The PGM Output will activate for two seconds after the panel receives the kissoff from the central station.

**[14] Ground Start (Shall not be used on UL Listed systems)**

The PGM Output will activate for two seconds before the panel attempts to dial to obtain dial tone on Ground Start telephone equipment. Two 2-second pauses should be inserted at the beginning of the phone number when using this option.

**[15] For future use**

**[16] LINKS 1000 Support (PGM1 Only)**

The PGM output will be used as a data wire to communicate phone number information for the LINKS 1000 cellular unit.

**[17] Away Armed**

The PGM will activate when the system is armed with the Home Away zones activated.

**[18] Home Armed**

The PGM will activate when the system is armed with the Home Away zones bypassed.

- .....
- Main Board PGM Outputs ..... Section [009]
- PC5208 PGM Output Options ..... Section [010]
- PC5204 PGM Output Options ..... Section [011]
- .....

**5.10.2 PGM Output Attributes**

Each Programmable Output also requires the PGM Attributes to be programmed before they will operate correctly. Attributes available are as follows:

- Option [1] - ON Partition 1 Controls Event  
OFF Partition 1 Does Not
- Option [2] - ON Partition 2 Controls Event  
OFF Partition 2 Does Not
- Option [3] - ON Output Activates on Event  
OFF Output Deactivates on Event

---

**!** *The Attribute Options for Option [09] System Trouble and [10] Latched System Event are different. Refer to these options for more information.*

---

- .....
- PGM1 (Main Board) Output Attributes ..... Section [141]
- PGM2 (Main Board) Output Attributes ..... Section [142]
- PC5208 PGM Output Attributes ..... Section [143] to [150]
- PC5204 PGM Output Attributes ..... Section [151] to [154]
- .....

**5.11 Telephone Line Monitor (TLM)**

The panel will supervise the presence of the phone line and indicate a trouble condition if disconnected. If **TLM Enabled** is selected the panel will wait the **TLM Trouble Delay** time before indicating the trouble so that a momentary interruption of the phone line will not cause a trouble condition.

The **TLM Trouble Only** or **Audible When Armed** option will allow you to select if the panel will indicate a trouble condition at the keypad or indicate a trouble at the keypad when disarmed and activate the alarm output when armed.

When the trouble condition is restored the panel can send a **TLM Restoral Reporting Code**. Any events that occurred while the phone line was down will also be communicated.

If the LINKS 1000 cellular communicator is being used the panel can be programmed to report a **TLM Trouble Reporting Code**.

- .....
- TLM Enable/Disable ..... Section [015], Option [7]
- TLM Trouble Only or Audible When Armed ... Section [015], Option [8]
- TLM Trouble Delay ..... Section [370]
- TLM Trouble Reporting Code ..... Section [349]
- TLM Restoral Reporting Code ..... Section [350]
- .....

**5.12 Siren Supervision**

The panel supervises the Bell output. If an open condition is detected or the fuse is blown the panel will immediately indicate a trouble condition and beep the keypad twice every ten seconds to alert the owner of the problem. The panel can send a **Bell Circuit Trouble** Reporting Code immediately. Once the problem is corrected the panel can send a **Bell Circuit Trouble Restoral** Reporting Code.

- .....
- Bell Circuit Trouble Reporting Code ..... Section [349]
- Bell Circuit Trouble Restoral Reporting Code Section [350]
- .....

**5.13 Test Transmission**

To ensure the communication link with the central station is functioning properly the panel can be programmed to send a test transmission signal.

The panel can send a **Periodic Test Transmission Reporting Code** at the programmed **Test Transmission Time of Day**. The **Test Transmission Cycle** determines the number of days (001 to 255) between tests. If the test transmission is being programmed with a lesser value than the previous value, the system will wait the original period before the next test transmission is sent, and then begin reporting with the new interval.

If the LINKS 1000 cellular communicator is being used the panel can also send a cellular test. If the **LINKS 1000 Test Transmission Code** is programmed the panel will send a cellular test at the same time as the land line test transmission.

The end user can generate a communicator test. If the **System Test Reporting Code** is programmed the panel will send the signal when the System Test keypad command is entered (See Section 3.4 “[\*] Commands, [\*][6] User Functions”).

.....

Periodic Test Transmission Reporting Code ..... Section [352]  
 Test Transmission Time of Day ..... Section [371]  
 Test Transmission Cycle ..... Section [370]  
 LINKS 1000 Test Transmission Reporting Code .... Section [352]  
 System Test Reporting Code ..... Section [352]

.....

**5.14 Fire, Auxiliary, Panic Keys**

The emergency keys are available on all keypads. These keys must be pressed and held for 2 seconds before they will activate. This 2 second delay is designed to help prevent accidental activation.

If the **Fire Keys** option is enabled, when the Fire keys are pressed and held for 2 seconds, the panel will activate the alarm output, pulsing one second on, one second off. If **Fire Bell Continuous** is selected the alarm output will sound until a code is entered, otherwise it will sound until a code is entered or the alarm output times out. Communication of the signal to central station is immediate.

If the **Auxiliary Keys** are pressed and held for 2 seconds the panel will sound the keypad beeper three times to verify activation. The panel will beep the keypad ten times rapidly to verify communication to the central station.

If the **Panic Keys** are pressed and held for 2 seconds, the panel will immediately communicate the signal to central station. If **Panic Keys Audible** is enabled, the panel will beep the keypad three times upon activation and activate the alarm output until a code is entered or the alarm output times out. Otherwise the alarm will be completely silent.

---

**!** *The Fire, Auxiliary, Panic keys will operate even if Keypad Blanking is active (See Section 5.23 “Keypad Blanking”).*

---

.....

Fire Keys Enable ..... Section [015], Option [1]  
 Panic Keys Audible ..... Section [015], Option [2]  
 Fire Bell Continuous ..... Section [014], Option [8]

.....

**5.15 Entry/Exit Delay Options**

Upon arming, the panel will begin the exit delay. If **Audible Exit Delay** is enabled the keypad will beep every second until the exit delay expires. The keypad will beep rapidly for the last 10 seconds of exit delay to warn the user the system is about to arm.

For commercial applications **Bell Squawk on Exit Delay** may be enabled. The panel will squawk the alarm output once every second when the exit delay is initiated and 3 times a second for the last 10 seconds until the exit delay expires.

Upon entry, if a Delay type zone is violated, the panel will begin entry delay. The keypad will emit a steady tone. The keypad will pulse the keypad sounder during the last 10 seconds to warn the user the system is about to go into alarm. If there was an alarm during the armed period, the keypad sounder will pulse for the entire entry delay to warn the user of the previous alarm.

For commercial applications **Bell Squawk on Entry Delay** may be enabled. The panel will squawk the alarm output once every second until the entry delay expires or the system is disarmed. This feature must not be used with 2 partitions.

---

**!** *Since two Delay zones are programmable, and therefore two different Entry Delays, when the panel is armed it will use the Entry Delay for the first Delay zone violated.*

---

If **Exit Delay Termination** is enabled the panel will monitor the Delay zones during exit delay. If a Delay type zone is violated then secured during the exit delay, the exit delay will be terminated and the panel will be armed immediately.

To prevent false alarms on exit the PC5010, use the built-in feature **Audible Exit Fault**. If a delay type zone is violated within 4 seconds after the exit delay has expired, the panel will sound the entry delay warning through the keypad and siren alerting the customer that an improper exit was made. If the panel is disarmed within the entry delay no signal is sent. If not, the panel will continue to sound the alarm and send a signal to central station.

.....

Audible Exit Delay .....	Section [014], Option [6]
Bell Squawk on Exit Delay .....	Section [014], Option [3]
Exit Delay Termination .....	Section [014], Option [7]
Bell Squawk on Entry Delay .....	Section [014], Option [4]

.....

### 5.16 Event Buffer

The panel will store the last 128 events that have occurred on the system. Each event will contain the time, date, partition and the event itself along with the zone number, user code number or any other information pertaining to the event.

If the **Event Buffer Follows Swinger Shutdown** feature is enabled the event buffer will not store events after the swinger shutdown level has been reached. This will prevent the panel from overwriting the entire buffer if a problem exists. (See Section 5.17 "Swinger Shutdown".)

The event buffer can be viewed three different ways. It can be viewed through an LCD keypad, printed on-site using the PC5400 printer module (See Section 5.29 "On-Site Printer") or it can be uploaded through the DLS software.

#### 5.16.1 Viewing the Event Buffer through the LCD Keypad

The following is the procedure for viewing the event buffer through the LCD keypad:

Step 1 - Enter [\*] [6] [Master Code]

Step 2 - Select 'View Event Buffer'

The keypad will display the Event Number, Partition, Time and Date of the event in question. Use the [\*] key to toggle between this information and the event itself. Use the arrow keys (<>) to scroll through the events in the buffer.

When you have finished viewing the event buffer press the [#] key to exit.

.....

Event Buffer Follows Swinger Shutdown .....	Section [013], Option [7]
---	---------------------------

.....

### 5.17 Swinger Shutdown

The swinger shutdown feature is designed to prevent a runaway communicator from tying up the central station. Different limits can be programmed for **Zone Alarms**, **Zone Tamper**s and **Maintenance** signals. After the panel has communicated the programmed number of transmissions for an event it will no longer report that event until the swinger shutdown is reset.

For example, the swinger shutdown limit for Zone Alarms is set to [003]. The panel will not send more than 3 alarm signals for each zone with a swinger attribute until the swinger shutdown is reset.

**Swinger Shutdown** will be reset when the panel is armed or every day at midnight. Once reset, the panel will again communicate normally.

.....

Swinger Shutdown Limit (Alarms) .....	Section [370]
Swinger Shutdown Limit (Tamper)s .....	Section [370]
Swinger Shutdown Limit (Maintenance) .....	Section [370]

.....

### 5.18 Transmission Delay

If **Transmission Delay** is selected for a zone the panel will delay reporting the alarm for the number of seconds programmed for **Transmission Delay Time**. If the panel is disarmed before the delay time expires the panel will not report the alarm to central station. If the panel is not disarmed in time the panel will communicate normally.

 **This is a global feature.**

.....  
 Transmission Delay Enable ..... Sections [101] to [132], Option [7]  
 Transmission Delay Time ..... Section [370]  
 .....

**5.19 Keypad Backlighting**

The keys of all the keypads can be backlit to provide easy viewing in dim lighting conditions. If the **Keypad Backlighting Option** is enabled the keys will be illuminated.

.....  
 Keypad Backlighting Option ..... Section [016], Option [5]  
 .....

**5.20 Arming/Disarming Options**

If the **Arm/Disarm Bell Squawk** option is enabled the panel will squawk the alarm output once upon arming and twice upon disarming. The **Opening After Alarm Keypad Ringback** option will give you the ability to beep the keypad 10 times rapidly if the panel is disarmed after an alarm occurred. The **Opening After Alarm Bell Squawk** option will give you the ability to squawk the bell output 10 times rapidly if the panel is disarmed after an alarm occurred.

**Closing Confirmation**, if enabled, will cause the keypad to beep 10 times rapidly after the closing reporting code has been transmitted to central station.

.....  
 Arm/Disarm Bell Squawk ..... Section [014], Option [1]  
 Opening After Alarm Keypad Ringback ..... Section [381], Option [1]  
 Opening After Alarm Bell Ringback ..... Section [381], Option [2]  
 Closing Confirmation ..... Section [381], Option [4]  
 .....

**5.21 Automatic Arming**

There are two different Auto-Arming methods available. Each Partition can be programmed to Auto-Arm at a specific time every day if it is in the disarmed condition. Also a Partition can also be programmed to Auto-Arm if no activity is registered for a programmed number of minutes.

Before the Auto-Arm at a specific time function will work correctly the present **Time of Day** must be programmed.

When the internal panel clock matches the **Auto-Arm Time** the panel will check the status of the Partition. If armed, the panel will do nothing until the next day at the **Auto-Arm Time**, when it will check again.

If disarmed the panel will sound the buzzer of all keypads assigned to the partition for one minute. If a valid User Code is entered the Auto-Arm will be aborted. The panel will also transmit an **Auto-Arm Abort Reporting Code** if programmed.

If no code is entered the panel will Auto-Arm. If a zone is violated the panel will transmit a **Partial Closing Reporting Code** if programmed to indicate the system was not secure. If the zone is restored the panel will add the zone back into the system.

If the **No Activity Arm** option for a partition is programmed with a number other than 000, the partition will Auto-Arm if no activity is detected for the programmed number of minutes.

The timer will begin when a delay type zone assigned to the partition is secured. The timer is stopped if any zone assigned to the partition is tripped. The timer will restart when a delay type zone is again restored.

When the timer expires the panel will sound the buzzer of all keypads assigned to the Partition for one minute. If any key is pressed, the Auto-Arm will be aborted.

---

**!** *Zones assigned to both Partitions (Global Zones) will not stop the timer.*

---

.....  
 Time Date ..... 3.4 [\*] Commands, [\*][6][1] Time and Date  
 Auto-Arm Time ..... 3.4 [\*] Commands, [\*][6][3] Auto-Arm Time  
 Auto-Arm Cancel Reporting Code ..... Section [348]  
 Partial Closing Reporting Code ..... Section [343]  
 No Activity Arm (Partition 1) ..... Section [162]  
 No Activity Arm (Partition 2) ..... Section [163]  
 .....

### 5.22 Keypad Lockout

The panel can be programmed to 'lockout' keypads if a number of incorrect user code entries are made. After the **Number of Invalid Codes Before Lockout** has been reached the panel will lock out the keypad for the **Lockout Duration** and log the event to the event buffer. For the duration of the lockout the panel will sound an error tone when any key is pressed.

**!** *Keypad Lockout will reset every hour.*

To disable Keypad Lockout program the **Number of Invalid Codes Before Lockout** as [000].

- .....
- Number of Invalid Codes Before Lockout ..... Section [012]
- Lockout Duration ..... Section [012]
- Keypad Lockout Reporting Code ..... Section [338]
- .....

### 5.23 Keypad Blanking

If the **Keypad Blanking Option** is enabled the panel will turn off all lights on the keypads except the backlighting of the keys if no key is pressed for 30 seconds.

The panel will turn the lights back on if entry delay begins or an audible alarm occurs. The lights will also come on if a key is pressed or, if the **Code Required to Restore Blanking Option** is enabled, a valid User Code is entered.

If the **Power Save Option** is enabled the panel will blank all keypad lights including backlighting when AC power fails, in order to conserve the back up battery.

- .....
- Keypad Blanking Option ..... Section [016], Option [3]
- Code Required to Restore Blanking ..... Section [016], Option [4]
- Power Save Option ..... Section [016], Option [6]
- .....

### 5.24 Loop Response

The normal loop response time for all zones is 500 milliseconds. The panel will not consider a zone violated unless it is violated for at least 500 milliseconds.

If **Zone 8 is Fast Loop Response** is enabled the loop response for zone 8 will be 40 milliseconds. Typically this can be used for vibration type sensors.

- .....
- Zone 8 is Fast Loop Response ..... Section [013], Option [5]
- .....

### 5.25 Keypad Tamper

If the **Keypad Tamper Enable** option is selected the panel will display and transmit a **General System Tamper** reporting code if any keypad is removed from the wall. When the keypad tamper is restored the panel will transmit the **General System Tamper Restoral** reporting code. All keypads should be properly installed and secured before enabling this option.

- .....
- Keypad Tamper Enable ..... Section [016], Option [8]
- General System Tamper Reporting Code ..... Section [338]
- General System Tamper Restoral Reporting Code .. Section [338]
- .....

### 5.26 LINKS 1000 Cellular Communicator

The LINKS 1000 cellular communicator can be used three different ways; as the sole communicator for the panel, as a back up for either or both phone numbers or as a redundant back up to the land line communicator (the panel will call both the land line and via the LINKS). A **LINKS Preamble** is programmable for each phone number in the event that the land line number is local but the LINKS is required to dial an exchange. When programming a LINKS Preamble, all unused digits must be programmed with a hexa decimal "F".

#### 5.26.1 Using LINKS 1000 as the Sole Communicator

The panel can be programmed to report only using the LINKS 1000 cellular communicator when an event occurs. To program this select only the LINKS 1000 for the **Communicator Call Direction** Options for the event. In addition the **Call LINKS** as well as **Land Line** option must also be enabled.

When the selected event occurs the panel will only attempt to call central station using the LINKS.

**5.26.2 Using the LINKS as a Backup Communicator**

The panel can be programmed to call using the LINKS 1000 cellular communicator if the panel is having difficulty communicating an event using the land line. To program this select both the phone number and LINKS options for the Communicator Call Direction Options for the event. In addition the LINKS is Backup of Land Lines option must be selected.

When used as a backup communicator the panel will attempt to call the central station in the following manner:

- the panel will try to call using land lines - if unsuccessful the panel will try to call using the LINKS
- if unsuccessful the panel will try to call using the land lines
- if unsuccessful the panel will try to call using the LINKS

This process will continue until the panel has successfully communicated with the central station or the **Maximum Dialing Attempts** has been reached.

**5.26.3 Using the LINKS as a Redundant Communicator**

The panel can be programmed to call using both the land line and the LINKS 1000 cellular communicator when an event occurs. To program this select both the phone number and the LINKS options for the **Communicator Call Direction** Options for the event. In addition the **Call LINKS** as well as **Land Line** option must be selected.

The panel will call the land line and then call using the LINKS when reporting the selected event.

.....

LINKS Preamble (First Telephone Number) ..... Section [390]  
 LINKS Preamble (Second Telephone Number) ..... Section [391]  
 LINKS Preamble (Third Telephone Number) ..... Section [392]  
 LINKS Preamble (Downloading Telephone Number) ... Section [490]  
 Communicator Call Direction Options ..... Section [361] to [368]  
 Call LINKS as well as Land Line ..... Section [380], Option [7]  
 Maximum Dialing Attempts ..... Section [160]

.....

**5.27 Wireless Expansion**

Any number of zones, up to 32, can be programmed as wireless. Adding wireless devices to the panel is done by simply selecting the zone number and entering the 5 digit ESN number written on the unit.

If the **Zones 1-4 Enable** Option is disabled zones 1 to 4 will be disabled for hardwire operation and wireless devices can be substituted. Also if **Zones 5-8 Enable** Option is disabled zones 5 to 8 will be disabled for hardwire operation and wireless devices can be substituted.

---

**!** *After disabling or enabling main board zones, the panel should be powered down. Do not add wireless devices to the same zone as a hardwire zone. Hardwire and wireless zones cannot share the same zone.*

---

Each wireless zone, WLS904, WLS905, WLS906, or WLS907 will send a supervisory round every 12 minutes. If the receiver hears from the wireless device at least once during the **Wireless Supervisory Window** it will not report a trouble. If the receiver does not it will generate a **General Zone Supervisory** trouble and reporting code. The panel will report Supervisory trouble by zone using the SIA format (See Section 5.6.1 "SIA").

Within the supervisory transmission the device will also indicate the status of the battery. If a low battery condition exists the panel will indicate a **General Transmitter Low Battery** trouble. The panel will delay reporting the event for the number of days programmed for **Wireless Low Battery Transmission Delay**. If the customer has been instructed on how to replace batteries this will prevent unnecessary reporting of the event provided the batteries are changed.

A PC5132 tamper will be logged to the event buffer or transmitted as a general system tamper under two conditions. It will first occur if the tamper terminals on the PC5132 are open; the tamper will be restored by shorting out these terminals. Second, a tamper will be logged when the PC5132 detects an attempt to impede RF signals. This advises the monitoring station that the wireless zone transmissions are not being received by the modules.

**5.27.1 Supervision of Wireless Zones**

- Step 1 - Enter Installer Programming
- Step 2 - Enter Program Section [804]
- Step 3 - Enter Sections [82], [83], [84] and [85] to enable or disable supervision by turning the bits on or off

---

**!** *The wireless zone attribute must be set for all enrolled wireless zones. The supervisory bit for any WLS908s enrolled on the system must be OFF.*

---

.....

PC5132 Programming ..... Section [804]

.....



**5.28 ESCORT5580 Module**

Many consumers will often purchase wants before needs. The alarm system is an identifiable need however rarely is it an item someone wants. The ESCORT5580 module will help you change the way in which they feel about security.

There are many benefits when adding the ESCORT5580 module to a security system. The ESCORT5580 module will turn any touch tone phone in the world into a fully functional keypad. Imagine the security a customer would feel if they had the ability to arm, disarm and check status of the alarm while at the office or on vacation.

In addition, all touch tone phones in the home also become fully functional keypads. This may help reduce the cost of the overall installation because additional keypads (and labour in running wires) can be eliminated.

The ESCORT5580 will also act as a tutor for the system. By speaking in clear, easy to understand sentences it helps guide a user through functions they may otherwise have difficulty with. Programmable zone labels (up to 6 words each from our library of over 240 words) makes the system even easier to use.

The module also has a built-in power line control interface and can control up to 32 power line control devices for lighting and temperature control, giving you the power to add home automation in a very cost effective manner. Devices can be activated individually, as a group, by schedule or can be activated when an event occurs on the system, such as an alarm.

Additional information can be found in the ESCORT5580 Installation Manual.

**5.29 On-Site Printer**

The panel, with the addition of the PC5400 printer module, will print all events as they occur to a local, on-site serial printer. All events printed will include the time, date, partition and the event.

If a problem develops with the printer, such as power loss or paper outage the panel will store events until the problem is corrected, at which point it will print the events from the buffer. The panel can store up to 128 events if such a condition occurs.

.....  
PC5400 Programming ..... Section [801]

**5.30 Audio Interface Module**

The PC5908 Audio Interface will allow you to connect up to 7 Interior (PC5901) or exterior (PC5901EXT) Intercom Stations. These attractive, surface mount stations contain both speaker and microphone and will allow you to add intercom features to your alarm system such as:

- Page/Answer
- Do Not Disturb
- Baby Listener Broadcast
- Answer Incoming Calls
- Doorbell Function
- Background Music

In addition to these features the module also has built-in two-way voice for central station monitoring. The central station can select the audio station, listen/talk, extend on-line time and hang up.

For more information regarding the PC5908 Audio Interface Module refer to the Installation Manual for the product.

.....  
PC5908 Programming ..... Section [802]

**5.31 Default (Factory)**

On occasion it may be necessary to default the main control panel or one of the modules that can be connected. There are several different defaults available including defaulting the main control panel, ESCORT5580 module, PC5132-900 Wireless Expander Module and PC5400 Printer module.

**Note: Defaulting the main panel does not default the keypads. Please refer to "Programming LCD5500 Keypads" in the Programming Worksheets for defaulting the LCD5500. LED55XX keypads must be manually reprogrammed in installers section [000].**

**5.31.1 Factory Default Main Panel (Hardware)**

- Step 1 - Remove AC and battery from the panel.
- Step 2 - Remove all wires from the Zone 1 and PGM1 terminals.
- Step 3 - With a piece of wire short the Zone 1 terminal to the PGM1 terminal.
- Step 4 - Apply AC power to the main panel.
- Step 5 - When Zone Light 1 is lit on the keypad the default is complete.
- Step 6 - Remove AC power from the control
- Step 7 - Reconnect all original wiring and power up the control.

---

**!** *AC power must be used to power the panel. The panel will not default if the battery is used.*

---

**5.31.2 Factory Default Main Panel (Software) and other Modules**

- Step 1 - Enter the Installer Programming mode.
  - Step 2 - Enter Program Section [XXX].
  - Step 3 - Enter the Installer Code.
  - Step 4 - Enter Program Section [XXX] again.
- The panel will take a few seconds to perform the default. When the keypad is again operational the default is complete.

.....

Restore Main Panel (Software) to Factory Default Programming .....	Section [999]
Restore ESCORT5580 to Factory Default Programming .....	Section [995]
Restore PC5132-900 to Factory Default Programming .....	Section [996]
Restore PC5400 to Factory Default Programming .....	Section [997]
Restore PC5908 to Factory Default Programming .....	Section [998]

.....

**5.32 Installer Lockout**

If **Installer Lockout** is selected a hardware default cannot be performed. If a software default is performed all programming will restore to factory default.

When **Installer Lockout Disable** is selected the panel will restore all programming to factory defaults if a hardware or software default is performed on the main control panel.

To enable or disable Installer Lockout perform the following:

- Step 1 - Enter Installer Programming
- Step 2 - Enter Program Section [XXX]
- Step 3 - Enter the Installer Code.
- Step 4 - Enter Program Section [XXX] again.

.....

Installer Lockout Enable .....	Section [990]
Installer Lockout Disable .....	Section [991]

.....

**5.33 Walk Test (Installer)**

The Installer Walk Test can be used to verify that each zone of the panel is working. To perform a Walk Test, enter the following:

- Step 1 - Enter Installer Programming
- Step 2 - Enter Section [901]

When any zone is violated the panel will activate the Bell Output for two seconds, log the event to the Event Buffer and communicate the alarm to central station.

To stop the test, you must do the following:

- Step 1 - Enter Installer Programming
- Step 2 - Enter Section [901]

# Hookup Diagram

## PC5010 CONTROL PANEL

**Incorrect connections may result in fuse failure or improper operation. Inspect wiring and ensure connections are correct before applying power. Do not route any wiring over circuit boards. Maintain at least 1" (25.4mm) distance.**

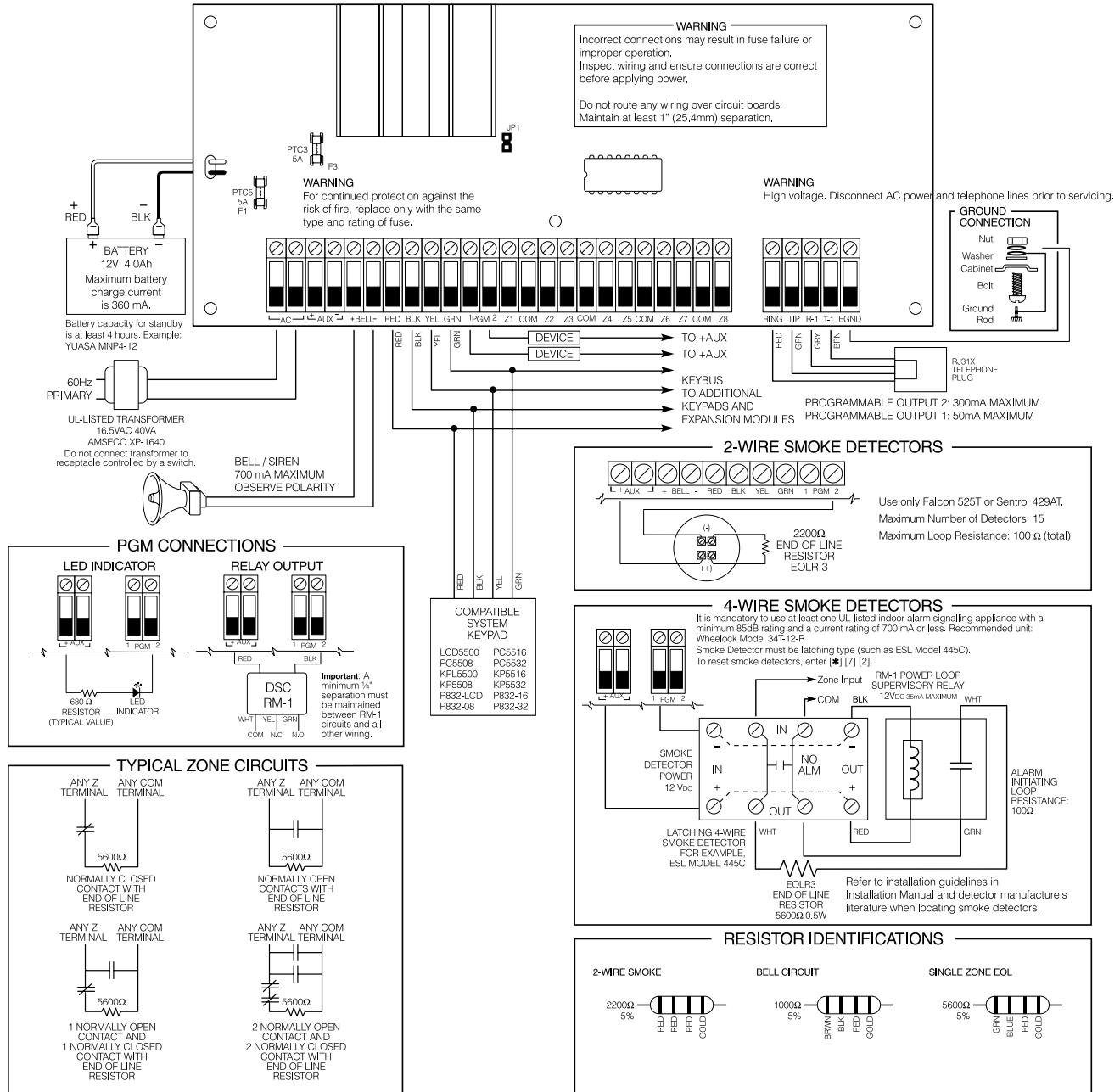

CONTROL UNIT (NON HIGH-RISE)



Temperature Range: 0°C-49°C (32°F-120°F)  
Maximum Humidity: 85% R.H.  
Refer to the Installation and Instruction Manuals for complete operating instructions.  
The PC5010 is UL-listed for limited energy installations per NEC Article 760. Recognized limited energy cable should be used. Observe NEC wiring requirements and local codes defined by the authority having jurisdiction.  
This equipment should be installed in accordance with ANSI/NFPA 72-1993 (National Fire Protection Association, Batterymarch Park, Quincy MA, 02269). Printed information describing proper installation, operation, testing, maintenance, evacuation planning, and repair service is to be provided with this equipment.  
Security detection devices that require power from the control panel must be UL-listed for the intended application and operate over the range of 11.6 - 12.6 Vdc (residential), 12.0 Vdc (commercial). The DSC Bravo Series is a recommended UL-listed motion detector.  
Compatible System Keypads: PC5508/KP5508/P832-08, PC5516/KP5516/P832-16, PC5532/KP5532/P832-32, LCD5500/KPL5500/P832-LCD

**WARNING: Not to be removed by anyone except occupant.**

Control Panel is suitable for the following UL installations:

- Household Fire and Grade A Household Burglary
- Grade A Local I Grade B Central Station and Police Connect with basic line security
- Grade C Central Station
- Refer to Installation manuals

This device complies with Parts 15 and 68 of the FCC rules. Operation is subject to the following two conditions: (1) this device may not cause harmful interference, and (2) this device must accept any interference received, including interference that may cause undesired operation.

FCC Reg. No.: F53CAN-22839-AL-E REN = 0.1B Plug Type: RJ31X  
Made in Canada

# Appendix A

## C O N T A C T I D

### Contact ID

The Partition ID Codes must be 4 digits. All reporting codes must be 2 digits.

The following is a list of Contact ID reporting codes. The first digit (in parentheses) will automatically be sent by the control. The last two digits are programmed to indicate specific information about the signal.

For example, if zone 1 is an entry/exit point, the alarm reporting code could be programmed as [34]. The central station would receive the following:

#### \*BURG - ENTRY/EXIT - 1

In the above example, the "1" indicates which zone went into alarm.



**Do not program the following reporting codes: Recent Closing and Event Buffer 75% Full.  
This communication format cannot be selected if Central Station Two-Way Voice is required.**

### Event Codes (as per ADEMCO):

#### Medical Alarms

- (1)AA Medical
- (1)A1 Pendant Transmitter
- (1)A2 Fail to Report In

#### Fire Alarms

- (1)1A Fire Alarm
- (1)11 Smoke
- (1)12 Combustion
- (1)13 Water Flow
- (1)14 Heat
- (1)15 Pull Station
- (1)16 Duct
- (1)17 Flame
- (1)18 Near Alarm

#### Panic Alarms

- (1)2A Panic
- (1)21 Duress
- (1)22 Silent
- (1)23 Audible

#### Burglar Alarms

- (1)3A Burglary
- (1)31 Perimeter
- (1)32 Interior
- (1)33 24 Hour
- (1)34 Entry / Exit
- (1)35 Day / Night
- (1)36 Outdoor
- (1)37 Tamper
- (1)38 Near Alarm

#### General Alarms

- (1)4A General Alarm
- (1)43 Exp. module failure
- (1)44 Sensor tamper
- (1)45 Module Tamper

#### 24 Hour Non-Burglary

- (1)5A 24 Hour non-Burg
- (1)51 Gas detected
- (1)52 Refrigeration
- (1)53 Loss of Heat
- (1)54 Water Leakage
- (1)55 Foil Break
- (1)56 Day Trouble
- (1)57 Low bottled Gas level
- (1)58 High Temp
- (1)59 Low Temp
- (1)61 Loss of Air Flow

#### Fire Supervisory

- (2)AA 24 Hour non-Burg
- (2)A1 Low Water Pressure
- (2)A2 Low CO2
- (2)A3 Gate Valve Sensor
- (2)A4 Low water level
- (2)A5 Pump activated
- (2)A6 Pump failure

#### System Troubles

- (3)AA System Trouble
- (3)A1 AC Loss
- (3)A2 Low System Battery
- (3)A3 RAM checksum bad\*
- (3)A4 ROM checksum bad\*
- (3)A5 System Reset\*
- (3)A6 Panel prog. changed\*
- (3)A7 Self-test failure
- (3)A8 System Shutdown
- (3)A9 Battery Test Failure
- (3)1A Ground Fault

#### Sounder / Relay Troubles

- (3)2A Sounder / Relay
- (3)21 Bell 1
- (3)22 Bell 2
- (3)23 Alarm Relay
- (3)24 Trouble Relay
- (3)25 Reversing

#### System Peripheral Troubles

- (3)3A System Peripheral
- (3)31 Polling Loop Open
- (3)32 Polling Loop Short
- (3)33 Exp. Module Failure
- (3)34 Repeater Failure
- (3)35 Local Printer Paper Out
- (3)36 Local Printer Failure

#### Communication Troubles

- (3)5A Communication
- (3)51 Telco 1 Fault
- (3)52 Telco 2 Fault
- (3)53 Lng-Rnge Rad. xmtr. fault
- (3)54 Fail to Communicate
- (3)55 Loss of radio super.
- (3)56 Loss of central polling

#### Protection Loop Troubles

- (3)7A Protection Loop
- (3)71 Protection Loop open
- (3)72 Protection Loop short
- (3)73 Fire Trouble

#### Sensor Troubles

- (3)8A Sensor Trouble
- (3)81 Loss of super. RF
- (3)82 Loss of super. RPM
- (3)83 Sensor Tamper
- (3)84 RF xmitter low batter

#### Open / Close

- (4)AA Open / Close
- (4)A1 O / C by User
- (4)A2 Group O / C
- (4)A3 Automatic O / C
- (4)A4 Late to O / C
- (4)A5 Deferred O / C
- (4)A6 Cancel
- (4)A7 Remote Arm / Disarm
- (4)A8 Quick Arm
- (4)A9 Keyswitch O / C

#### Remote Access

- (4)11 Callback request made\*
- (4)12 Successful Download access\*
- (4)13 Unsuccessful access\*
- (4)14 System Shutdown
- (4)15 Dialer Shutdown

#### Access Control

- (4)21 Access denied
- (4)22 Access report by user

#### System Disables

- (5)AA-(5)1A

#### Sounder / Relay Disables

- (5)2A Sounder / Relay disable
- (5)21 Bell 1 disable
- (5)22 Bell 2 disable
- (5)23 Alarm relay disable
- (5)24 Trouble relay disable
- (5)25 Reversing relay disable

#### System Peripheral Disables

- (5)3A-54A

#### Communication Disables

- (5)51 Dialer disabled
- (5)52 Radio xmitter disabled

#### Bypasses

- (5)7A Zone bypass
- (5)71 Fire bypass
- (5)72 24 Hour zone bypass
- (5)73 Burg bypass
- (5)74 Group bypass

#### Test / Misc.

- (6)A1 Manual Trigger Test\*
- (6)A2 Periodic Test report\*
- (6)A3 Periodic RF xmission\*
- (6)A4 Fire test\*
- (6)A5 Status report to follow\*
- (6)A6 Listen-in to follow
- (6)A7 Walk test mode

\* Restore not applicable

# Appendix B

## S I A F O R M A T

### SIA Format

#### Level 2 (Hardcoded)

The SIA communication format used in this product follows the level 2 specifications of the SIA Digital Communication Standard - February 1993. This format will send the Account Code along with its data transmission. At the receiver, the transmission would look similar to this example:

N Ri01 BA 01

N = New Event

Ri01 = Partition / Area Identifier

BA = Burglary Alarm

01 = Zone 1

#### PC5010 Reporting Codes

#### SIA Identifiers & Auto-Reporting Code

Delay Zone Alarm/Restore .....	BA-XX / BH-XX *
Instant Zone Alarm/Restore .....	BA-XX / BH-XX *
Interior Zone Alarm/Restore .....	BA-XX / BH-XX *
Delay H.A. Zone Alarm/Restore .....	BA-XX / BH-XX *
Interior H.A. Zone Alarm/Restore .....	BA-XX / BH-XX *
24 Hr Burg Zone Alarm/Restore .....	BA-XX / BH-XX *
Standard Fire Zone Alarm/Restore .....	FA-XX / FH-XX *
Delayed Fire Zone Alarm/Restore .....	FA-XX / FH-XX *
24 Hr Supervisory Buzzer Zone Alarm/Restore ..	UA-XX / UH-XX *
24 Hr Supervisory Zone Alarm/Restore .....	UA-XX / UH-XX *
24 Hr Panic Zone Alarm/Restore .....	PA-XX / PH-XX *
24 Hr Holdup Zone Alarm/Restore .....	HA-XX / HH-XX *
24 Hr Gas Zone Alarm/Restore .....	GA-XX / GH-XX *
24 Hr Heat Zone Alarm/Restore .....	KA-XX / KH-XX *
24 Hr Emergency Zone Alarm/Restore .....	QA-XX / QH-XX *
24 Hr Sprinkler Zone Alarm/Restore .....	SA-XX / SH-XX *
24 Hr Water Zone Alarm/Restore .....	WA-XX / WH-XX *
24 Hr Freeze Zone Alarm/Restore .....	ZA-XX / ZH-XX *
24 Hr Latching Tamper Alarm/Restore .....	BA-XX / BH-XX *
Duress Alarm .....	HA-00
Opening After Alarm .....	OR-00
Recent Closing .....	CR-00
Zone Expander Supervisory Alarm/Restore .....	UA-00/UH-00
Keypad Fire Alarm/Restore .....	FA-00 / FH-00
Keypad Auxiliary Alarm/Restore .....	MA-00 / MH-00
Keypad Panic Alarm/Restore .....	PA-00 / PH-00
2-Wire Smoke Alarm/Restore .....	FA-99 / FH-99

#### PC5010 Reporting Codes

#### SIA Identifiers & Auto-Reporting Code

Zone Tamper (1-32) .....	TA-XX *
Zone Tamper Restorals (1-32) .....	TR-XX *
General System Tamper/Restore .....	TA-00 / TR-00
Keypad Lockout .....	JA-00
Closing By Access Codes 1-32, 33, 34, 40-42 .....	CL-XX ◆
Partial Closing .....	CG-XX ▼
Special Closing (DLS, Keys, Maint, Quick) .....	CL-00
Opening By Access Codes 1-32, 33, 34, 40-42 .....	OP-XX ◆
Auto-Arm Cancellation .....	CE-00
Special Opening (DLS, Keys, Maint) .....	OP-00
Battery Trouble Alarm/Restore .....	YT-00/YR-00
AC Failure Trouble Alarm/Restore .....	AT-00/AR-00
Bell Circuit Trouble Alarm/Restore .....	UT-99/UJ-99
Fire Trouble Alarm/Restore .....	FT-00/FJ-00
Auxiliary Power Supply Trouble Alarm/Restore ...	YP-00/YQ-00
TLM Trouble Code (via LINKS) .....	LT-00
General System Trouble/Restore .....	YX-00/YZ-00
General System Supervisory/Restore .....	ET-00/ER-00
TLM Restoral .....	LR-00
FTC Restoral .....	YK-00
Event Buffer 75% Full Since Last Upload .....	JL-00
DLS Lead In .....	RB-00
DLS Lead Out (Successful) .....	RS-00
Periodic Test Transmission .....	RP-00
System Test .....	RX-00
LINKS1000 Test Transmission Code .....	TX-00
General Transmitter Low Battery/Restore .....	XT-00/XR-00
General Zone Trouble/Restore .....	UT-00/UJ-00

\* Zone Number is Identified

◆ User Number is Identified

▼ Each Zone Number is Identified (using UB-XX)

**UL Listed Commercial and Residential Installations**

The installation requirements listed below must be met for the following grades of service.

**Grade A Local**

The installation must have a bell UL Listed for mecatile local alarms (AMSECO MBL10B with model AB-12 bell housing).

The digital communicator must be enabled.

The control panel must be in the Attack Resistant Enclosure (DSC Model CMC-1).

**Grade B Central Station and Police Connect**

The installation must have a bell UL Listed for mecatile local alarms (AMSECO MBL10B with model AB-12 bell housing).

The digital communicator must be enabled.

The control panel must be in the Attack Resistant Enclosure (DSC Model CMC-1).

**Grade C Central Station**

The digital communicator must be enabled.

The control panel must be in the Attack Resistant Enclosure (DSC Model CMC-1).

**All Commercial Installations**

- The entry delay must not exceed 60 seconds
- The exit delay must not exceed 60 seconds.
- The minimum bell cutoff time is 15 minutes.

**Residential Installations**

- The entry delay must not exceed 45 seconds
- The exit delay must not exceed 60 seconds.
- The minimum bell cutoff time is 4 minutes.

**Programming**

The notes in the programming sections describing the system configurations for UL Listed installations must be implemented.

**Control of the Protected Premises**

In order to have a UL Certificated system the protected area is to be under the responsibility of one ownership and management (i.e. one business under one name). This may be a group of buildings attached or unattached with different addresses but under the responsibility of someone having mutual interest. The person of mutual interest is not the alarm installing company.

**Bell Location**

The alarm sounding device (bell) must be located where it can be heard by the person or persons responsible for maintaining the security system during the daily arming cycle.

**Protection of the Control Unit**

The local control and the local power supply must be protected by one of the following ways:

- The control unit and audible alarm device must be in a protected area which is armed 24 hours a day.
- Each partition shall arm the area protecting the control unit and the audible alarm device power supply. This may require duplicate protection armed by each partition. Access to this protected area, without causing an alarm, will require that all partitions be disarmed.

In all cases described above, the protected area for the control unit must be programmed as not bypassable.

**Casual Users**

The installer should caution the user(s) to not give system information to casual users (e.g. codes, bypass methods, etc. to baby-sitters or service people). Only the One-Time Use codes should be given to casual users.

**User Information**

The installer should advise the users and note in the user instruction manual:

- Service organization name and telephone number
- The programmed exit time
- The programmed entry time



---

© 1997 Digital Security Controls Ltd.  
1645 Flint Road, Downsview, Ontario, Canada M3J 2J6  
Tel. (416) 665-8460 • Fax (416) 665-7498 • Tech. Line 1-800-387-3630  
Printed in Canada 29002199 R1

# Installation Manual

**DSC**<sup>TM</sup>  
**Power 832**<sup>TM</sup>  
S E C U R I T Y S Y S T E M

---

PC5010  
Version 1.1



## FCC COMPLIANCE STATEMENT

**CAUTION:** Changes or modifications not expressly approved by Digital Security Controls Ltd. could void your authority to use this equipment.

This equipment has been tested and found to comply with the limits for a Class B digital device, pursuant to Part 15 of the FCC Rules. These limits are designed to provide reasonable protection against harmful interference in a residential installation. This equipment generates, uses and can radiate radio frequency energy and, if not installed and used in accordance with the instructions, may cause harmful interference to radio communications. However, there is no guarantee that interference will not occur in a particular installation. If this equipment does cause harmful interference to radio or television reception, which can be determined by turning the equipment off and on, the user is encouraged to try to correct the interference by one or more of the following measures:

- Re-orient the receiving antenna.
- Increase the separation between the equipment and receiver.
- Connect the equipment into an outlet on a circuit different from that to which the receiver is connected.
- Consult the dealer or an experienced radio/television technician for help.

The user may find the following booklet prepared by the FCC useful: "How to Identify and Resolve Radio/Television Interference Problems". This booklet is available from the U.S. Government Printing Office, Washington D.C. 20402, Stock # 004-000-00345-4.

## IMPORTANT INFORMATION

This equipment complies with Part 68 of the FCC Rules. On the side of this equipment is a label that contains, among other information, the FCC registration number of this equipment.

**NOTIFICATION TO TELEPHONE COMPANY** Upon request, the customer shall notify the telephone company of the particular line to which the connection will be made, and provide the FCC registration number and the ringer equivalence of the protective circuit.

FCC Registration Number: F53CAN-22839-AL-E

Ringer Equivalence Number: 0.1B

USOC Jack: RJ-31X

**TELEPHONE CONNECTION REQUIREMENTS** Except for the telephone company provided ringers, all connections to the telephone network shall be made through standard plugs and telephone company provided jacks, or equivalent, in such a manner as to allow for easy, immediate disconnection of the terminal equipment. Standard jacks shall be so arranged that, if the plug connected thereto is withdrawn, no interference to the operation of the equipment at the customer's premises which remains connected to the telephone network shall occur by reason of such withdrawal.

**INCIDENCE OF HARM** Should terminal equipment or protective circuitry cause harm to the telephone network, the telephone company shall, where practicable, notify the customer that temporary disconnection of service may be required; however, where prior notice is not practicable, the telephone company may temporarily discontinue service if such action is deemed reasonable in the circumstances. In the case of such temporary discontinuance, the telephone company shall promptly notify the customer and will be given the opportunity to correct the situation.

**ADDITIONAL TELEPHONE COMPANY INFORMATION** The security control panel must be properly connected to the telephone line with a USOC RJ-31X telephone jack.

The FCC prohibits customer-provided terminal equipment be connected to party lines or to be used in conjunction with coin telephone service. Interconnect rules may vary from state to state.

**CHANGES IN TELEPHONE COMPANY EQUIPMENT OR FACILITIES** The telephone company may make changes in its communications facilities, equipment, operations or procedures, where such actions are reasonably required and proper in its business. Should any such changes render the customer's terminal equipment incompatible with the telephone company facilities the customer shall be given adequate notice to the effect modifications to maintain uninterrupted service.

**RINGER EQUIVALENCE NUMBER (REN)** The REN is useful to determine the quantity of devices that you may connect to your telephone line and still have all of those devices ring when your telephone number is called. In most, but not all areas, the sum of the RENs of all devices connected to one line should not exceed five (5.0). To be certain of the number of devices that you may connect to your line, you may want to contact your local telephone company.

**EQUIPMENT MAINTENANCE FACILITY** If you experience trouble with this telephone equipment, please contact the facility indicated below for information on obtaining service or repairs. The telephone company may ask that you disconnect this equipment from the network until the problem has been corrected or until you are sure that the equipment is not malfunctioning.

Digital Security Controls Ltd. 160 Washburn St., Lockport, NY 14094

## Limited Warranty

Digital Security Controls Ltd. warrants that for a period of twelve months from the date of purchase, the product shall be free of defects in materials and workmanship under normal use and that in fulfillment of any breach of such warranty, Digital Security Controls Ltd. shall, at its option, repair or replace the defective equipment upon return of the equipment to its repair depot. This warranty applies only to defects in parts and workmanship and not to damage incurred in shipping or handling, or damage due to causes beyond the control of Digital Security Controls Ltd. such as lightning, excessive voltage, mechanical shock, water damage, or damage arising out of abuse, alteration or improper application of the equipment.

The foregoing warranty shall apply only to the original buyer, and is and shall be in lieu of any and all other warranties, whether expressed or implied and of all other obligations or liabilities on the part of Digital Security Controls Ltd. This warranty contains the entire warranty. Digital Security Controls Ltd. neither assumes, nor authorizes any other person purporting to act on its behalf to modify or to change this warranty, nor to assume for it any other warranty or liability concerning this product.

In no event shall Digital Security Controls Ltd. be liable for any direct, indirect or consequential damages, loss of anticipated profits, loss of time or any other losses incurred by the buyer in connection with the purchase, installation or operation or failure of this product.

**Warning: Digital Security Controls Ltd. recommends that the entire system be completely tested on a regular basis. However, despite frequent testing, and due to, but not limited to, criminal tampering or electrical disruption, it is possible for this product to fail to perform as expected.**

# Table of Contents

## Section 1 - System Introduction

1.1	Specifications .....	1
1.2	Additional Devices .....	2
1.2.1	Keypads .....	2
1.2.2	PC5108 Eight Zone Expander Module .....	2
1.2.4	PC5132-900 Wireless Receiver Module .....	3
1.2.5	PC5204 Power Supply Output Module .....	4
1.2.6	PC5208 Eight Low Current Output Module .....	4
1.2.7	ESCORT5580 Module .....	4
1.2.8	PC5908 Audio Interface Module .....	4
1.2.9	PC5400 Printer Module .....	5
1.2.10	LINKS 1000 Cellular Communicator .....	5
1.2.11	Cabinets .....	5
1.2.12	Backplates .....	6
1.3	Out of the Box .....	6

## Section 2 - Getting Started

2.1	Installation Steps .....	7
2.2	Terminal Descriptions .....	7
2.3	KEYBUS Operation and Wiring .....	9
2.4	Current Ratings - Modules and Accessories .....	9
2.5	Assigning Zones to Zone Expanders .....	10
2.6	Keypad Assignment .....	10
2.6.1	How to Assign Keypads .....	10
2.6.2	How to Program Function Keys .....	11
2.7	Enable Supervision .....	11
2.8	Removing Modules .....	11
2.9	Zone Wiring .....	12
2.9.1	Normally Closed (NC) Loops .....	12
2.9.2	Single End Of Line (EOL) Resistors .....	12
2.9.3	Double End of Line (DEOL) Resistors .....	12
2.9.4	Fire Zone Wiring - 4 wire Smoke Detectors .....	13
2.9.5	Fire Zone Wiring - 2 wire Smoke Detectors .....	13
2.9.6	Keyswitch Zone Wiring .....	13
2.9.7	LINKS Supervisory .....	13
2.9.8	LINKS Answer .....	14

## Section 3 - Keypad Commands

3.1	Access Codes .....	15
3.2	Arming/Disarming .....	15
3.3	Auto Bypass (Shall not be used on UL Listed systems) ..	16
3.4	[*] Commands .....	16
	[*]+[1] Zone Bypass/Reactivate Stay/Away Zones .....	16
	[*]+[2] Trouble Display .....	17
	[*]+[3] Alarm Memory .....	18
	[*]+[4] Door Chime On/Off .....	18
	[*]+[5] Programming Access Codes .....	18
	[*]+[6] User Functions .....	19
	[*]+[7] Output Functions .....	20
	[*]+[8] Installer Programming .....	20
	[*]+[9] Arming Without Entry Delay .....	20
	[*]+[0] Quick Arm/Quick Exit .....	20
3.5	Function Keys .....	21
3.5.1	Function Key Options .....	21
3.6	Global and Partition Keypad Operation .....	22

## Section 4 - How to Program

4.1	How to Enter Installer Programming .....	23
4.2	Programming Decimal Data .....	23
4.3	Programming HEX Data .....	23
4.4	Programming Toggle Option Sections .....	24
4.5	Viewing Programming .....	24
4.5.1	LED Keypads .....	24
4.5.2	LCD Keypad .....	24

## Section 5 - Program Description

5.1	Zone Definitions .....	25
5.2	Zone Attributes .....	26
5.3	Communicator - Dialing .....	27
5.4	Communicator - Phone Numbers .....	27
5.5	Communicator - Account Numbers .....	28
5.6	Communicator - Reporting Formats .....	28
5.6.1	Pulse Formats .....	28
5.6.2	Contact ID .....	29
5.6.3	SIA (Level 2) .....	29
5.6.4	Pager Format .....	29
5.7	Communicator - Reporting Codes .....	30
5.7.1	Zone Alarm .....	30
5.7.2	Zone Restoral .....	30
5.7.3	Closings .....	30
5.7.4	Openings .....	30
5.7.5	Tampers .....	30
5.7.6	Priority/Emergency .....	31
5.7.7	Maintenance .....	31
5.7.8	Test Transmissions .....	31
5.7.9	Wireless Maintenance .....	31
5.7.10	Miscellaneous .....	32
5.8	Downloading .....	32
5.9	Partitions/Zone Assignment .....	33
5.10	PGM Outputs .....	33
5.10.1	PGM Output Options .....	33
5.10.2	PGM Output Attributes .....	35
5.11	Telephone Line Monitor (TLM) .....	35
5.12	Siren Supervision .....	35
5.13	Test Transmission .....	36
5.14	Fire, Auxiliary, Panic Keys .....	36
5.15	Entry/Exit Delay Options .....	36
5.16	Event Buffer .....	37
5.16.1	Viewing the Event Buffer through the LCD Keypad .....	37
5.17	Swinger Shutdown .....	37
5.18	Transmission Delay .....	37
5.19	Keypad Backlighting .....	38
5.20	Arming/Disarming Options .....	38
5.21	Automatic Arming .....	38
5.22	Keypad Lockout .....	39
5.23	Keypad Blanking .....	39
5.24	Loop Response .....	39
5.25	Keypad Tampers .....	39
5.26	LINKS 1000 Cellular Communicator .....	39
5.26.1	Using LINKS 1000 as the Sole Communicator .....	39
5.26.2	Using the LINKS as a Backup Communicator .....	40
5.26.3	Using the LINKS as a Redundant Communicator .....	40
5.27	Wireless Expansion .....	40
5.27.1	Supervision of Wireless Zones .....	40
5.28	ESCORT5580 Module .....	41
5.29	On-Site Printer .....	41
5.30	Audio Interface Module .....	41
5.31	Default (Factory) .....	41
5.31.1	Factory Default Main Panel (Hardware) .....	42
5.31.2	Factory Default Main Panel (Software) and other Modules	42
5.32	Installer Lockout .....	42
5.33	Walk Test (Installer) .....	42

<b>PC5010 Control Panel Hookup Diagram .....</b>	<b>43</b>
--	-----------

<b>Appendix A - Contact ID .....</b>	<b>44</b>
--------------------------------------	-----------

<b>Appendix B - SIA Format .....</b>	<b>45</b>
--------------------------------------	-----------

<b>Programming LCD5500 Keypads .....</b>	<b>Programming Worksheets</b>
--	-------------------------------

---