

INSTALLATION MANUAL



PC2500

This device complies with Parts 15 and 68 of the FCC rules. Operation is subject to the following two conditions: (1) this device may not cause harmful interference, and (2) this device must accept any interference received, including interference that may cause undesired operation.

FCC Reg. No.: F534J3-10411-AL-E

REN = 0.0B Plug Type : RJ31X

MADE IN CANADA

TABLE OF CONTENTS

1. SPECIFICATIONS		3
2. FEATURES		4
3. INSTALLATION		
Bench Testing		5
Mounting Panel		6
Hook-up Procedure		6
Terminal Connections(Description of all Terminals)		6
Keypad Installation		8
Power-up Procedure		8
Hook-up Diagram		9
Fire Alarm Diagram/Keypad diagram		10
Locating Smoke Detectors		11
System Testing		12
Instructing the End User		12
4. KEYPAD FUNCTIONS		
Introduction		12
Master code		13
Installers' Code		13
Arming		13
Auto-Bypass/Home-Away Arming		13
Entry Delay Off Arming	[*][9][USER CODE]	14
Disarming		14
Zone By-passing(Shunting)	[*][1]	14
Trouble Display	[*][2]	14
Alarm Memory Display	[*][3]	15
Switched Aux. Power Supply	[*][Hold Down 4]	15
Programming New User Codes	[*][5][Master Code]	15
Programming Other User Functions	[*][6][Master Code]	16
-setting the internal clock		17
-automatic arm		17
-quick arm		17
-door chime		17
-installers test		17
-bell test		17
Utility Output Command	[*][7] or [*][7][User Code]	18
Installers' Programming Commands	[*][8][Installer Code]	18
"At-Home" Arming Command	[*][9][User Code]	18
"Quick-Arm" Command	[*][0]	18
Keypad Zones		18
5. PROGRAMMING GUIDE [*][8][Installer Code] Commands		
[00] Binary Programming(special applications only)		19
[01] 1st Telephone Number		19
[02] 1st Account Code Number		19
[03] 2nd Telephone Number		19
[04] 2nd Account Code Number		19
[05] Alarm Reporting Codes Zones 1 to 8		20

[06] Restoral Reporting Codes Zones 1 to 8	21
[07] Utility Alarm Reporting Codes	21
[08] Utility Restoral Reporting Codes	22
[09] Closing Reporting Codes By User Codes 1 to 8	22
[10] Opening Reporting Codes By User Codes 1 to 8	23
[11] Miscellaneous Reporting Codes	23
[12] Definitions for Zones 1 to 8	23
[13] 1st System Definition Code	24
[14] 2nd System Definition Code	25
[15] Zone Shunt Mask	25
[16] System Times	26
Entry Delay (Seconds)	
Exit Delay (Seconds)	
Bell Cut Off Time (Minutes)	
AC Failure Transmission Delay (Minutes)	
Standard Loop Response Time (Times 10 Msec)	
Test Transmission Repeat Time (Days)	
[17] System Clock Times (HH:MM In 24 HR Format)	26
Auto Arm Time	
Test Transmission Time	
[18] New Installers (Programmers) Code	26
[19] New Master Code	26
[20] Future Use	26
[21] Communications Format	26
1st Telephone Number Format	
2nd Telephone Number Format	
[22] Programmable Input and Output Options	28
Auxiliary Input Options	
Programmable Output Options	
[23] Group A Zone Assignments	29
[24] Group B Zone Assignments	29
[25] Access Code Group A Assignment	29
[26] Access Code Group B Assignment	29
[27] Transmission to 1st or 2nd Telephone Number Options	30
Group A Alarms and Restorals	
Group B Alarms and Restorals	
Group A Openings, Closings and Partial Closings	
Group B Openings, Closings and Partial Closings	
Priority Alarms and Restorals	
Maintenance Alarms and Restorals	
[28] Reset EEPROM Memory to Factory Defaults	30
[50] EEPROM Copy Routine (Making Master Chips)	30
6. PROGRAMMING WORK SHEET	32
7. FCC COMPLIANCE STATEMENT	37
8. LIMITED WARRANTY	38

COPYRIGHT 1989 DIGITAL SECURITY CONTROLS LTD. 1645 FLINT RD., DOWNSVIEW, ONTARIO
CANADA M3J 2J6 TEL (416) 665-8460 1-800-387-3630

SPECIFICATIONS

CONTROL PANEL SPECIFICATIONS

13 zones including:

- 8 fully programmable supervised zones (EOL resistors)
- 1 fire supervised circuit
- 1 auxiliary normally open zone
- 3 Keypad activated zones

Audible alarm output:

- bell output - 650 mA, Fused at 5 Amps, 11 VDC unregulated
- steady and pulsed output

EEPROM memory:

- does not lose codes or system status on complete AC and battery failure

Programmable voltage output:

- 50 ma output voltage
- operation controllable through program options

Powerful 1.5 amp regulated power supply:

- 350 ma auxiliary supply, 11 VDC unregulated
- separately fused for battery, keypad/auxiliary supply and bell output
- supervision for loss of AC power, low battery
- internal clock locked to AC power frequency

Switched Smoke Detector Supply Output:

- controlled from keypad ([*][4] keypad command)

Battery required:

- 12 volt minimum 1.2 AH rechargeable gel-cell or sealed lead-acid battery

Transformer required:

- 16.5 VAC, 40VA

Dimensions:

- 9.5" x 11.8" x 3.3" deep

Weight:

- 6.5 lbs.

REMOTE KEYPAD SPECIFICATIONS (PC2500RK)

Four wire (QUAD) hook-up and up to 5 keypads per system

Built-in piezoelectric sounder

Full annunciation of zones and system status

Nominal current draw 60 ma

Dimensions 5.5" x 3" x 1" deep

OUTPUT VOLTAGE SPECIFICATION:

DUE TO THE REQUIREMENTS OF UL STANDARDS # 985 AND # 1023, IT IS REQUIRED TO INDICATE AN OUTPUT VOLTAGE OF 11 VDC, UNREGULATED. TYPICALLY, WITH NORMAL AC IN AND A FULLY CHARGED BATTERY, THE OUTPUT VOLTAGE WILL BE 13.8 VDC. WITH AC OFF AND A DISCHARGED BATTERY, THE VOLTAGE WILL GO TO 10 VOLTS. DEVICES THAT REQUIRE POWER FROM THE CONTROL PANEL SHOULD BE CAPABLE OF NORMAL OPERATION OVER THE VOLTAGE RANGE OF 10 TO 14 VDC.

DIGITAL COMMUNICATOR SPECIFICATIONS

56 reporting codes

Transmits all 10BPS and 20BPS in single line and extended formats

Radionics Rounds and Radionics Parity formats

DTMF and Pulse dialing

DPDT line seizure

True dial tone detection

Anti-jam feature

Two telephone numbers and two account codes

Split reporting of selected transmissions to each telephone number

Programmable to "enable" or "disable" the communicator

FEATURES

Keypad Programming

The PC2500 comes with a default program so it is operational with a minimum of programming. It is completely programmed from the keypad. The panel uses EEPROM memory so that all information is retained even if the panel loses both AC and battery power. A built-in EEPROM copy command which almost eliminates programming.

Multiple Level Static/Lightning Protection

The PC2500 has been carefully designed and tested to provide reliable service. It is built to take Static and Lightning induced surges and keep on working. Multiple level surge filters are on all zone inputs, the power supply, the keypad connections, the bell output, the auxiliary power supply and the telephone interface. A special "ZAP-TRAC" circuit board configuration catches high voltage impulses right at the wiring terminals. Protective ground planes surround sensitive areas preventing the spread of damaging voltage surges. Metal Oxide Varistors (MOV's) are placed in all the critical areas to further reduce impulses to safe levels.

"WATCHDOG MONITOR" Circuit

Even when all precautions are taken so that voltage surges do not cause damage to the control panel, it is possible to cause temporary disruption to the operation of the microprocessor causing it to lose track of the program sequence. The PC2500 is equipped with an external "Watchdog Monitor" circuit which continually checks the microprocessor program execution.

System Supervision Features

The PC2500 continuously monitors a number of possible trouble conditions including:

- an active battery supervision circuit that periodically tests the battery under load,

- a loss of the AC power supply,

- a supervised circuit trouble condition,

- a telephone line monitoring circuit,

- a bell circuit failure indicates open circuit or fuse failure,

- a test code feature which transmits a communicator test code to the monitoring station at a selected time every day. The test code can be sent every 1 up to every 99 days.

- a bell/siren test feature which can be activated from the keypad.

Advanced Features

The PC2500 has many advanced features. Features which provide the security system design flexibility and selling advantage necessary to win those demanding jobs and make them profitable.

Some of these features include:

- EEPROM memory retains all data even on complete AC and battery failure. Panel powers up in last arm or disarm state before power loss.

- All programmable zones may be selected as one of 10 different types including; delay, double delay, quadruple delay, instant, follower, follower with home-away and 4 types of 24 hour emergency and supervisory circuits.

- Keypad programming of up to eight security codes.

- Zone by-passing from the keypad.

- Individual zone and system function indicators on keypad.

- A keypad activated utility output function for operating lights, door openers, cameras or other devices.

Although the PC2500 has many features, it is not difficult to use. All keypad commands are similar and are assisted by audible and visual cues.

INSTALLATION

Bench Testing

The PC2500 contains a factory default program. Any additional programming required is done through the keypad. For many applications all that will be required is to enter the telephone number and alarm codes with keypad entries that are as straight forward as dialing a telephone number. If you need help talk to your DSC equipment distributor or phone our toll free technical HOT LINE 1-800-387-3630.

Connect 1K ohm 1/2 watt end of line resistors from each zone (Z1 to Z8) input to the closest common "COM" terminal. Connect an end of line resistor between the "FIRE" input terminal and the "COM" terminal between "Z1" and "Z2". Unless all zone loops properly terminated with end of line resistors the "READY" light will not be on and the panel will not arm unless the "READY" light is on.

Connect the four keypad wires to the control panel as shown in the connection drawing.

To completely test the PC2500 including the communicator data, it is necessary to connect the panel to a digital receiver through a telephone line connection or by connecting the telephone terminals on the PC2500 to a digital communicator test set such as the DSC DTS-1. The DSC DTS-1 digital communicator test set is an inexpensive unit which can simulate the telephone system dial tone and the receiver hand shake and kiss-off tones as well as display the data sent out by a digital communicator. Also, the DTS-1 has a "listen-in" feature which makes it ideal for monitoring the transmission between communicator and receiver when the PC2500 is connected to the telephone line.

If you are using a DTS-1, connect the red and green telephone clips to the "TIP" and "RING" terminals and connect the red and black power clips to the "AUX+" and "AUX-" terminals on the PC2500. When power is applied to the panel press the red local-line button on the DTS-1 and observe the display window area. The "local-line" indicator should be in the local position.

For testing purposes, so that the sound level is not too loud, connect a small buzzer to the "BELL+" and "BELL-" terminals to indicate when the panel is in alarm.

Connect a 16.5 VAC, 40 VA transformer to the "AC" terminals. Before plugging in the transformer be sure the circuit board is not resting on anything metallic which may cause a short.

When the transformer is plugged in there should be lights on the keypad and the buzzer connected to the bell terminals may go on for a few seconds. The "ARMED" light may be on or off the first time the panel is powered. The last armed/disarmed condition is stored in the EEPROM memory so the panel will always power up in the last armed/disarmed state. If the "ARMED" light is on, enter the default master code [1234] to disarm the panel. If the keypad is not active, check for the presence of AC power at the "AC" terminals, check the keypad connections and check the panel fuses.

If all the zones are properly connected with end of line resistors all of the zone lights will be off. Note that the panel will arm only if all zones are properly connected with end of line resistors (including FIRE circuit) so that the "READY" light is on. The keypad should beep several times to indicate acceptance of the master code. Enter the master code to arm or disarm the panel.

Read the "KEYPAD COMMANDS" section of this manual or the USER INSTRUCTION MANUAL and enter commands on the keypad to become familiar with the different commands.

Turn to the "PROGRAMMING GUIDE" in this manual and enter a sample program into the panel through the keypad to become familiar with the programming commands.

Mounting Panel

Select a dry location close to an unswitched AC source, close to a ground connection and close to the telephone connection.

Remove printed circuit board, mounting hardware and keypad from cardboard retainer inside panel. Before attaching cabinet to wall, press the five white nylon printed circuit board mounting studs and the ground connection screw into cabinet from the back.

Pull all cables into cabinet and prepare them for connection before mounting the circuit board to the back of the cabinet. Press circuit board down onto mounting studs.

Hook-up Procedure

DO NOT connect transformer or battery until all other wiring has been connected. See power-up procedure.

Connect a ground cable from the cabinet ground connection by the shortest and most direct route to a cold water pipe ground or a grounding rod.

Connect zone cables to zone loop inputs. Put end of line resistors on any unused zones. Connect wires supplying power to motion detectors to auxiliary supply.

Install keypads and connect wires to keypad terminals on panel.

Connect RJ31-X cord to telephone terminals. Do not insert plug into RJ31-X jack.

Warning: FCC restricts using this equipment on certain types of telephone lines. Read FCC COMPLIANCE STATEMENT at the end of this manual. Also, do not use this equipment on a telephone line equipped with "call holding" feature because the tone generated may interfere with the communicator operation.

Connect bell or siren to "BELL+" and "BELL-" terminals. Observe correct polarity for sirens and polarized bells. Connect 1K ohm 1/2 watt resistor across terminals to eliminate trouble condition if bell circuit is not being used.

Terminal Connections

AC Power Terminals "AC"

Use a 16.5 VAC transformer with a minimum 40 VA rating to supply AC power to the PC2500. The transformer should not be connected to an outlet that is controlled by a switch. If AC failure occurs it is displayed as a trouble on the keypad (see KEYPAD COMMANDS [•][2] trouble conditions). It can also be transmitted to the monitoring station as a trouble condition (see PROGRAMMING GUIDE [•][8] section 07 and 08 for alarm and restore codes and section 16 for transmission delay).

Auxiliary Power Terminals "AUX" and "GND"

The auxiliary power supply can be used to power motion detectors and other devices requiring 11VDC. 350ma 11VDC is available from the "AUX"(positive) and "GND"(negative) terminals when the PC2500 is used with one keypad. For each additional keypad the auxiliary supply rating must be reduced by 60ma. The auxiliary supply is fused with the keypad supply at 1 amp. Auxiliary fuse failure transmission can be sent (see [*][8] section 7 and 8).

Switched Auxiliary Power Terminals "SW AUX" and "GND"

The switched auxiliary supply can be switched off momentarily from the keypad (see KEYPAD COMMANDS [*][4]). The "SW AUX" terminal is positive and the "GND" terminal negative. The 350 ma auxiliary supply rating must be reduced by any current taken from the switched auxiliary supply. The switched supply shares the same fuse as the auxiliary supply.

Bell/Siren Terminals "BELL+" and "BELL-"

These terminals are for powering bells or other audible devices requiring a steady output voltage on alarm. The bell output is fused for 5 amps. When connecting sirens (speakers with siren driver already built-in), be sure to observe the correct polarity. Connect the positive lead to the "BELL+" terminal and the negative lead to the "BELL-" terminal.

The bell/siren alarm output is pulsed (1 second on 1 second off) when alarm is created by the [1],[3] keypad zone or by the FIRE zone.

Keypad Terminals "RED", "BLK", "YEL" and "GRN"

Connect the four colored wires from the keypads to these terminals. When connecting more than one keypad, connect in parallel across the keypad terminals on at the control panel (i.e. all RED wires together, all BLACKS together, all YELLOWS together and all GREENS together). The keypad red and black power supply terminals are fused through the auxiliary fuse.

Programmable Output Terminal "PGM OUT"

The operation of the Programmable Output varies depending upon which option is selected in the programming table. See the PROGRAMMING GUIDE section [22] for a list of options for the "PGM OUT" output. The "PGM OUT" is a switch to ground. A 100 ohm current limiting resistor is connected in series. A small relay, a buzzer or other DC operated device may be connected between the 11VDC "AUX"(positive) terminal and the "PGM OUT"(switched negative) terminal on the main board.

Auxiliary Input Terminal "AUX IN" (also KEY ARMING)

The "AUX IN" input terminal is a normally open 24 hour zone. It can be programmed from the keypad to be silent or audible. There is no display on the keypad for the "AUX IN" input. An alarm on this input is created by applying a positive voltage or by closing a contact between the "AUX IN" terminal and the positive auxiliary supply. See Programming Guide [*][8] sections [07] and [08] for programming the alarm and restoral codes. The Aux. input is intended to be used as a burglary input zone only.

The "AUX IN" terminal can also be used as a momentary key arming/disarming input. See PROGRAMMING GUIDE section [22] for a list of options for the "AUX IN" terminal. The keyswitch Arming feature must be implemented using a UL listed device.

"FIRE" Zone Input

The "FIRE" zone is a supervised (normally open alarm initiating contact) end-of-line resistor circuit designed to accept "Latching" four-wire smoke detectors. (see fire circuit installation diagram)

On alarm, (fire loop shorted) the bell output will pulse the signal to indicate that the fire loop has been activated. Transmission by the digital communicator is delayed 30 seconds. If the alarm is acknowledged, by pressing the [#] key, the signals will silence and, if the 30" delay has not expired, the transmission will be aborted. If the alarm is not acknowledged and the 30" delay expires, the transmission proceeds and cannot be aborted.

If after signal silence, the smoke detector is not restored to normal, the signals will resound after 90" and 30" after that, the communicator will transmit. If the signals resound, they may again be silenced, [#] key, and the communicator will be aborted if silence occurs within the 30" delay period.

To restore the smoke detector to normal, clear all products of combustion from the detector and reset the detector by pressing [*] and then holding down [4] for 2 or 3 seconds. This action will remove power from the smoke detector and if it is clear of smoke, the detector will return to normal. If the detector is still in alarm, the signals will sound immediately and the above sequence will repeat.

For an open on the FIRE loop, the keypad sounder will beep twice every 10" and the "TROUBLE" light will show on the keypad. The communicator will transmit the trouble condition if programmed for trouble transmission. The audible trouble signal may be silenced by pressing the [#] key. To determine the nature of the trouble, press [*][2]. (see the "TROUBLE DISPLAY" section)

Zone Input Terminals "Z1" to "Z8"

Zone inputs "Z1" to "Z8" are supervised end of line (E.O.L.) resistor circuits. Each input must be terminated with a 1K ohm E.O.L. resistor. An alarm condition will be created if a normally open contact is used to short across the E.O.L. resistor. An alarm is also created if normally closed contacts, wired in series with the E.O.L. resistor, are opened. See the wiring diagram for normally open and normally closed contact connection. The type of circuit or zone definition (delay, instant, 24 hour etc.) is programmed from the keypad using the [*][8] installer programming commands (PROGRAMMING GUIDE section 12).

Telephone Terminals "TIP", "RING", "T-1" and "R-1"

The wires from the RJ31-X telephone jack are connected to these terminals in the following way.

TIP	green wire from RJ31-X cord
RING	red wire from RJ31-X cord
T-1	brown wire from RJ31-X cord
R-1	grey wire from RJ31-X cord

Battery Connections

Do not connect the battery or the transformer until the wiring is complete. Connect the red battery lead to the positive battery terminal and the black lead to the negative battery terminal. If the connection is made in the reverse the battery fuse will blow. The small "pot" below the heat sink can be used to adjust the battery charging voltage. It is factory adjusted for 13.8 volts and normally needs no adjustment.

Keypad Installation

Mount the keypads near the exit-entry doors. The PC2500RK keypad has a red, a black, a green and a yellow wire on the back. Connect these four wires to the four keypad terminals on the control panel using four conductor (quad) telephone wire. Up to five keypads may be connected to one PC2500. Connect all green wires from the keypads to the "GRN" terminal on the panel. Connect all yellow wires from the keypads to the "YEL" terminal on the panel. Connect all red wires from the keypads to the "RED" terminal. Connect all black wires from the keypads to the "BLK" terminal. The blue wire loop on the back of the keypad can be programmed to switch on the programmable output "PGM OUT" (see section [22] PROGRAMMING GUIDE). Cut the blue loop and connect one or more normally closed contacts in series. When the loop is opened the "PGM OUT" terminal switches to ground.

Power-up Procedure

If the keypads are located a distance from the panel, install an extra keypad temporarily at the panel during power up and testing. An extra keypad with a short length of cable and alligator clips attached is helpful for testing and programming PC2500 systems.

Connect the transformer.

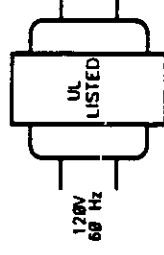
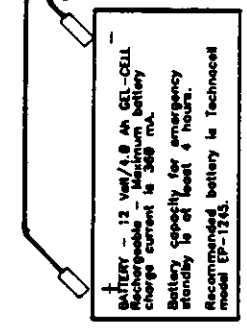
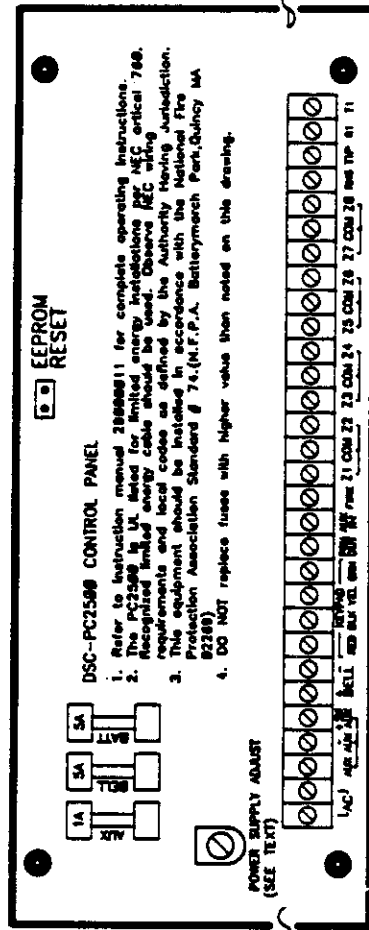
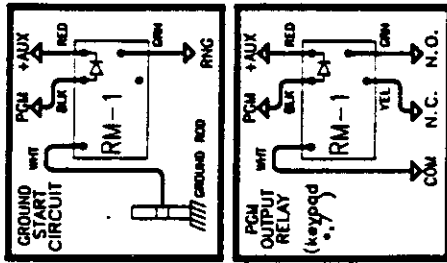

TRANSFORMER - 16.5 VAC 40VA
 Do not connect transformer to a receptacle controlled by a switch. The transformer must be UL listed and have a restraining means.

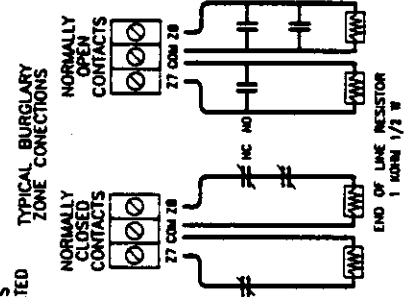
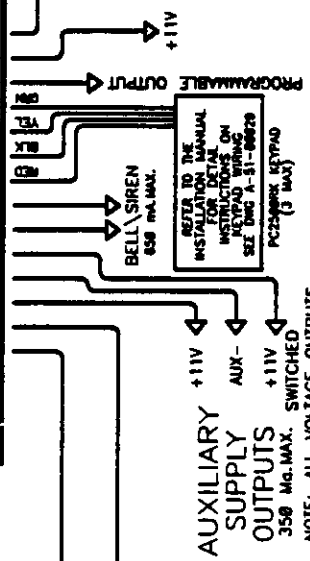
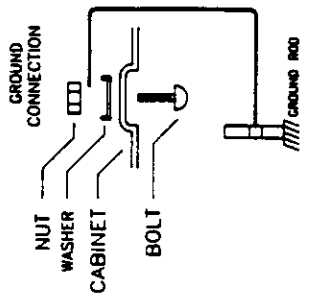

SECURITY DETECTION DEVICES THAT REQUIRE POWER FROM THE CONTROL PANEL MUST BE UL LISTED FOR THE OPERATING VOLTAGE RANGE OF 16.0 TO 14.8 VDC. THE FOLLOWING ARE UL LISTED MOTION DETECTORS:
 MACAL MODEL R-700
 SENTRY MODEL 8185
 VISIONIC MODEL SHN-2000
 ASSUR MODEL RT-350

TYPICAL FIRE ALARM ZONE CONNECTION

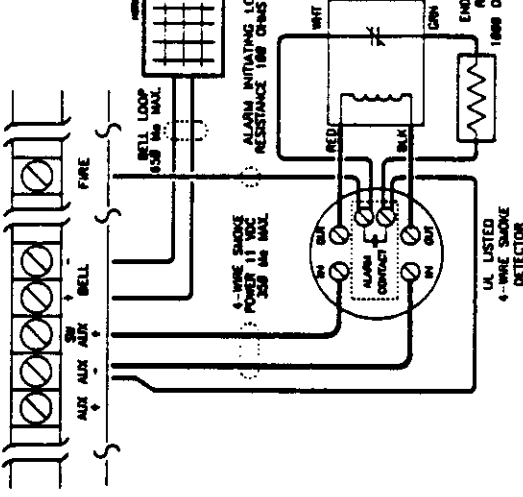

IT IS MANDATORY TO USE ONE UL LISTED INDOOR ALARM SCHEDULING APPLIANCE WITH A MINIMUM 85 OHM RATING AND A CURRENT RATING OF 650 mA OR LESS. RECOMMENDED UNIT - WHEELER MODEL 341-12-4 HORN

NOTE: SMOKE DETECTORS MUST BE LATCHING TYPE (FOR MODEL 1812) TO RESET SMOKE DETECTORS-PRESS (4) THEN HOLD DOWN KEY (4) FOR 2-3 SECONDS

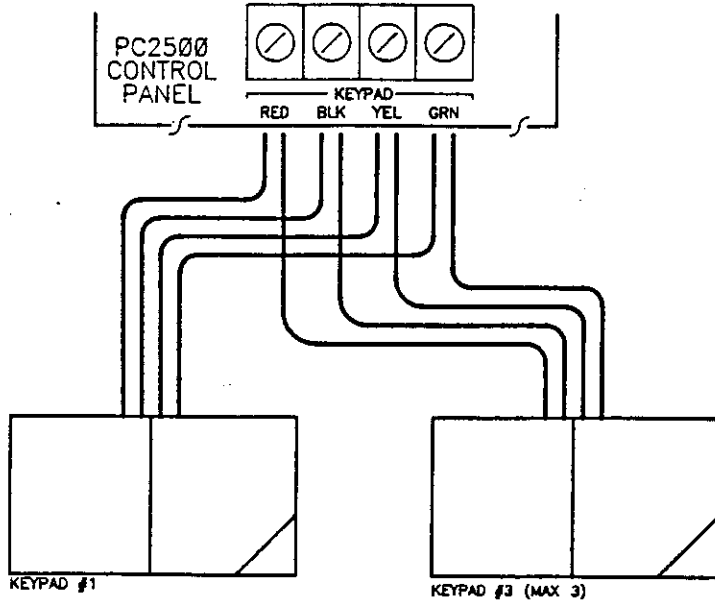

HINT:

If two wires of the same gauge are paralleled, the run length can be doubled. eg. if 8 #22awg wires (2-RED,2-BLK,2-YEL,2-GRN) are run to the keypad, the run length would double from 1000 ft. to 2000ft.

NOTES:

1. Each keypad has four coloured leads, Red,Black,Yellow and Green. Connect the leads to the corresponding terminals on the panel.
2. Up to five keypads may be connected in parallel. DO NOT connect multiple keypad on the same loop.
3. The wiring table gives the maximum wire run from the control panel to the keypad for various gauges of wire. Wire run lengths are calculated based on the maximum current drawn by the keypad. eg. All lights "ON".
4. For standby loading purposes, it is recommended that a current draw of 20 ma per keypad be used. This represents the panel in the "disarmed" state with two zones in alarm.

WIRING CHART-PC2500RK	
WIRE GAUGE	MAX. RUN LENGTH KEYPAD TO PANEL
24 AWG.....	640 FEET
22 AWG.....	1000 FEET
20 AWG.....	1600 FEET
19 AWG.....	2000 FEET
18 AWG.....	2600 FEET

PC2500 CONTROL PANEL

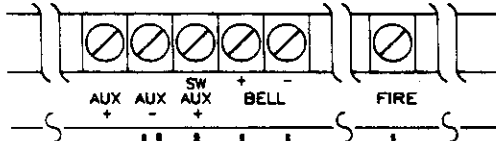

PC2500 FIRE LOOP HOOKUP

DRW.# B-51-88816

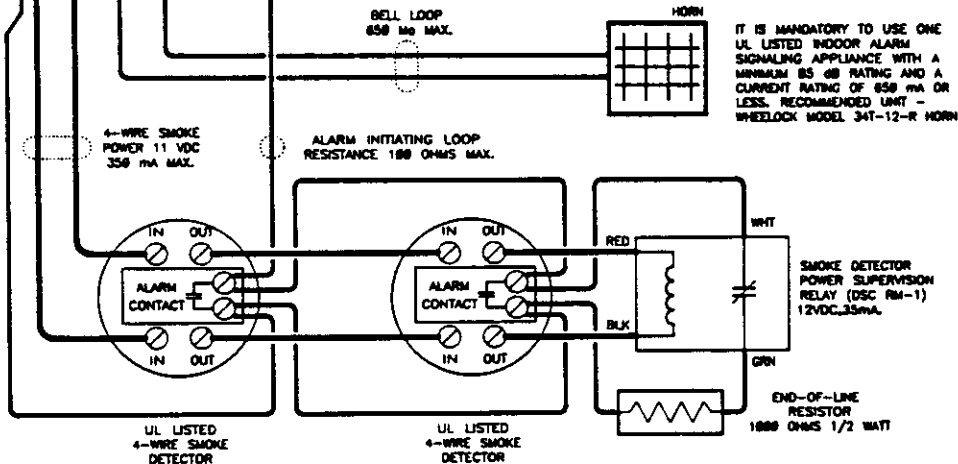

NOTE: SMOKE DETECTORS MUST BE LATCHING TYPE (BRK MODEL 1812) TO RESET SMOKE DETECTORS-PRESS (e) THEN HOLD DOWN KEY (4) FOR 2-3 SECONDS

ALARM INITIATING LOOP WIRING CHART	
WIRE GAUGE	MAX. WIRE RUN TO END-OF-LINE RESISTOR
14	15500
16	9740
18	6120
19	4860
20	3640
21	3060
22	2420

BELL LOOP WIRING CHART					
BELL CURRENT	AWG #14	AWG #16	AWG #18	AWG #19	AWG #22
Ma.	MAX. WIRE RUN TO BELL/SIREN FEET				
50	2750	1740	1090	860	433
100	1375	870	545	434	216
200	690	435	278	217	108
300	460	290	188	144	75
400	345	215	135	100	54
500	275	178	105	84	43
600	230	148	88	72	36

SMOKE POWER LOOP WIRING CHART					
LOOP CURRENT	AWG #14	AWG #16	AWG #18	AWG #19	AWG #22
Ma.	MAX. WIRE RUN TO EOL RELAY FEET				
50	2750	1740	1090	860	433
100	1375	870	545	434	216
200	690	435	278	217	108
300	460	290	188	144	75

GUIDELINES FOR SMOKE DETECTOR LOCATION

Experience has shown that all hostile fires in family living units generate smoke to a greater or lesser extent. Experiments using typical fires in family living units indicate that detectable quantities of smoke precede detectable levels of heat in most cases. For these reasons, NFPA standard 74 requires smoke detectors to be installed outside of each sleeping area and on each additional story of the family living unit.

The following information is for general guidance only and it is recommended that NFPA standard 74 be consulted and that the smoke detector manufacturer's literature be used for detail installation instructions.

It is recommended that additional smoke detectors beyond those required be installed for increased protection. The added areas include: Basement, Bedrooms, Dining rooms, Furnace room, Utility room and Hallways not protected by the required detectors.

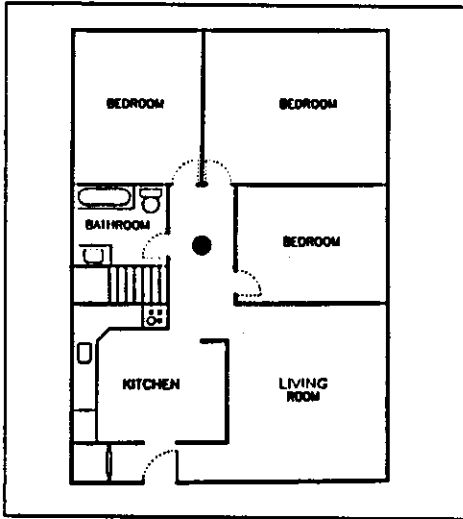

Fig. 1 - A smoke detector should be located between the sleeping area and the rest of the family living unit.

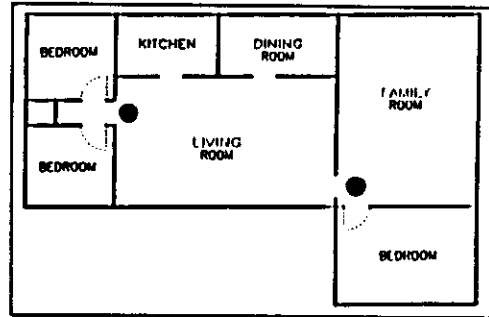

Fig. 2 - In family living units with more than one sleeping area, a smoke detector should be located to protect each sleeping area.

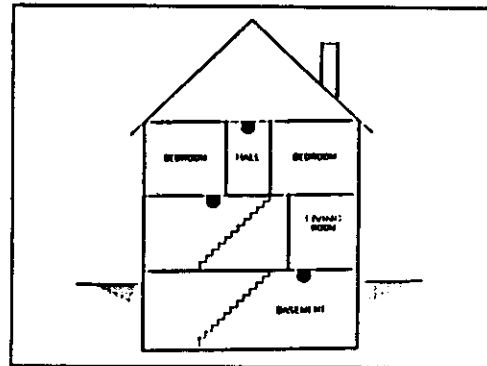

Fig. 3 - A smoke detector should be located on each story of the living unit.

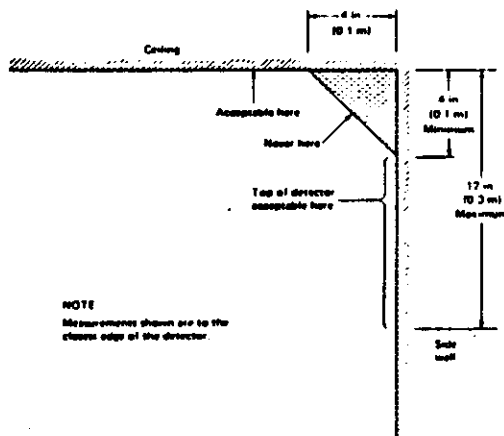

Fig. 4 - Smoke Detector mounting — "Dead" Air Space. The smoke from a fire generally rises to the ceiling, spreads out across the ceiling surface and begins to bank down from the ceiling. The corner where the ceiling and wall meet is an air space into which the smoke may have difficulty penetrating. In most fires, this "dead" air space measures about 4 in. (0.1 m) along the ceiling from the corner and about 4 in. (0.1 m) down the wall as shown in Figure 4. Detectors should not be placed in this "dead" air space.

Enter a few keypad commands and open a zone to be sure that the panel and keypad are responding to signals. If keypad does not respond and there are no indicators on, check for AC voltage at the "AC" terminals. If there is 16 VAC present, check that the keypad wiring is correct and check the keypad/auxiliary supply fuse. If the keypad/auxiliary supply fuse is blown check for a short between the keypad red and black wires before replacing the fuse.

If the keypad is responding normally, connect the battery. The red battery lead attaches to the positive battery post and the black battery lead attaches to the negative battery post.

System Testing

Using the [*] [8] command at the keypad, enter short exit and entry times to make testing easier. Check the KEYPAD COMMAND section for details on the [*] [8] command.

Arm panel(see keypad commands), wait for exit delay to expire(all lights on keypad except armed light will go out), then open a door contact or trip a detector. Disarm panel after each alarm and check the alarm memory. Test all contacts and detectors on each zone by opening and closing doors and windows and walking through the path of all motion detectors. If the building is occupied, shunt all zones except the one being tested. After all detectors and contacts are checked, remove the AC and battery power for a few seconds to clear the panel of all stored alarms which have not been transmitted to the monitoring station then connect the power.

Contact the monitoring station to request a transmission test. Plug the telephone cord into the RJ31-X jack. If a DTS-1 is being used to monitor communicator transmissions, connect as described in BENCH TESTING section and place the DTS-1 in the line mode by pressing the red "LINE/LOCAL" button. Arm the panel, wait for the exit delay to expire and trip a detector on an instant circuit. Wait for the communication to complete. Disarm panel and check with the monitoring station to confirm the transmission. Perform additional transmissions required by the monitoring station.

Check the "TROUBLE" light on the keypad. If it is on, press [*] then [2] to determine if there is a system trouble. TROUBLE DISPLAY section in KEYPAD COMMANDS gives a description of the different trouble conditions.

Program the exit, entry and alarm cut-off times to the desired values. Program the 24 hour test code transmission time if required. Program the internal clock time, auto arm/disarm times if used and the test code transmission time if used. Activate any other features being used.

Instructing End-User

Fill out the system reference guide in the PC2500 user instruction manual. Check off sections in manual which apply to the user's system and make additional notes if necessary.

Describe the system to an authorized user. Describe arming and disarming procedures. Describe the basic keypad functions. Assist the user in working through examples of each type of command.

Provide user with the instruction manual and instruct them to read the manual to become familiar with the system operation.

Instruct the user to test the system on a regular basis as described in the user manual.

The Master Code should be changed from the default setting and recorded in the End User Manual.

KEYPAD FUNCTIONS

INTRODUCTION

The PC2500RK remote keypad provides complete information and control of the PC2500 control panel. The panel can be fully programmed from the keypad. The 8 zone lights and the fire alarm light provide alarm and status indication for the alarm circuits. The 6 function lights guide the user in operating the system. The built-in sounder lets the user hear correct key entries and other alert signals. The 12 digit keypad is used for code entry and other programming functions. All keypad entries are made by pressing one key at a time, with the exception of "KEYPAD ZONE" activation.

The keypad is normally resting in the arm/disarm mode. In this condition the zone lights are indicating the opening and closing of zones. The READY LIGHT comes on when all zones are closed. The system can be directed to perform other functions such as zone shunting, displaying trouble conditions, displaying alarm memory and programming by entering one of the various [*] commands described below. Pressing the [#] key or not making any key entry for 2 minutes always returns the keypad to the arm/disarm mode.

MASTER CODE:

A default master security code "1234" is programmed into the PC2500 at the factory. The master security code is used for arming and disarming the control panel, for programming up to seven additional security codes using the [*][5] command and for entering other user functions using the [*][6] command. The master code can be reprogrammed. Because the PC2500 uses EEPROM memory the codes and other data are retained even after complete AC and battery failure. The Master Code should be changed from the default setting and recorded in the End User Manual.

INSTALLER'S PROGRAMMING CODE:

A default installer's programming code "2500" is programmed into the PC2500. This code is used with the [*] [8] command by the installer to gain access to the system in order to enter panel or communicator program information. The installer's program code may be changed by the installer.

ARMING:

Before Arming the panel, close all protected doors and windows and stop movement in areas covered by motion detectors. If the Trouble light is on, check for the type of trouble ([*],[2] command) and correct the fault condition. If the Bypass light is on, insure that the zones bypassed are bypassed intentionally. ([*],[1] command)

If the READY light is not on, one or more zones is open. The system can only be Armed when the READY light is ON.

To ARM, enter a [4 digit Security Code]. As each digit is entered, the keypad sounder will beep. When the correct Security Code has been entered the ARMED light will come ON and the keypad buzzer will sound a series of short beeps.

If the Security Code was entered incorrectly, the keypad buzzer will sound steadily for 2 seconds. Press the [#] key and enter the Security Code again.

When the correct Security Code has been entered and the Armed light is on, exit through the designated Entry/Exit door before the Exit Delay time expires. At the end of the allowed Exit time, all lights on the keypad will go out except the Armed light.

See Installer's Programming section, [*],[8] command for instructions on changing the Exit Delay time.

AUTO-BYPASS/HOME-AWAY ARMING

If a correct Security Code is entered, and you do not exit the premises, the system will, at the end of the Exit delay time, Arm with interior zones automatically Bypassed if those interior zones have been programmed as "Home-Away" zones. The Bypass light will come on. (see programming section [12], Zone Definitions for programming zones as "Home-Away")

This is a convenience feature for the user who wishes to remain at home with the system armed. The user does not have to manually Bypass the interior zones.

To reactivate the interior zones that have been automatically Bypassed, press [*],[1]. The Bypass light will go out. This command is a quick method of fully Arming the system before going to bed and is useful for the user who has a keypad outside the areas protected by the interior zones.

ENTRY DELAY OFF ARMING

To eliminate the Entry Delay, Arm the system using [*],[9],[ANY VALID USER CODE]. The Armed light will flash to remind the user that the system is Armed. An exit may be made as in normal Arming. The system will arm as described above in "Auto-Bypass/Home Away" arming whether an exit is made or not.

DISARMING:

Enter the premise through the designated exit-entry door. The keypad sounder will be on. Go to the keypad and enter the [4 digit security code]. If an error is made in entering the code, press the [#] key and enter the code again. The 'ARMED' light will go out and the keypad sounder will stop. The correct security code must be entered before the allowed entry time expires. To change the entry time see "INSTALLERS PROGRAMMING COMMAND [*][8]". If an alarm occurred while the panel was armed, the 'MEMORY' light and the 'ZONE' light which caused the alarm will start to flash and stay flashing for 2 minutes when the panel is disarmed. Pressing the [#] key returns the panel to the normal arm/disarm mode. If enabled, the bell will sound twice when the panel is disarmed. (Section [14])

ZONE BY-PASSING (SHUNTING): [*]+[1]

A by-passed zone or shunted zone will not cause an alarm. If a zone is by-passed the panel may be armed ("READY" light will be on) even if the zone is open. Use zone shunting when access is needed to part of the protected area. Also, damaged wiring or contacts on a zone may be temporarily shunted until repairs can be made so that the panel can be armed.

To shunt zones, enter [*],[1] and the zone number(s) to be shunted. Press [#] to return to 'READY'(arm/disarm mode). To remove all shunts, enter [*],[1],[0],[#]. The 'ZONE' lights which are on, while the "SHUNT" light is flashing, indicate the shunted zones. Remember that if no keypad entry is made for more than 2 minutes the keypad will return to the normal arm/disarm display. Then, in order to by-pass a zone the complete command must be re-entered. Once the shunt command is entered, pressing [9] recalls the last zone or group of zones which was by-passed. If the same group of zones is by-passed each time, this shunt recall feature can be used instead of having to by-pass zones individually.

When the PC2500 is programmed, the ability to shunt certain zones may be eliminated. In this case, the 'ZONE' lights for those zones will not come on in response to the shunt command. See the "Zone Shunt Mask" instruction in the [*][8] installer programming section. If the "SHUNT" light is on when arming the panel, the [*][1] command should be used to see which zones are by-passed so that zones are not unintentionally by-passed. Zone shunts are automatically cancelled when the panel is disarmed.

TROUBLE DISPLAY: [*]+[2]

The PC2500 continuously monitors a number of possible trouble conditions. If one of these conditions occurs, the keypad 'TROUBLE' indicator will light and the audible will sound (two short beep every 10 seconds). When the [#] key is pressed the audible indication will stop but the trouble indicator light will remain on until the trouble is cleared. Trouble conditions can also be transmitted to the monitoring station (see PROGRAMMING GUIDE section 07 and 08 for alarm and restoral trouble codes).

Press the [*] then [2] keys to display the type of trouble. The 'ZONE' lights indicate the type of trouble condition.

- 1- LOW STANDBY BATTERY
- 2- AC POWER FAILURE
- 3- FOIL LOOP TROUBLE
- 4- TELEPHONE LINE TROUBLE
- 5- UNSUCCESSFUL COMMUNICATION ATTEMPT WITH MONITORING STATION
- 6- BELL CIRCUIT FAILURE
- 7- SMOKE DETECTOR LOOP TROUBLE
- 8- LOSS OF TIME ON INTERNAL CLOCK

Press the [#] to return to 'READY'.

- 1- LOW BATTERY... A battery trouble will be displayed and can be reported if the battery is weak, disconnected or the battery fuse is blown. Only one low battery alarm or restoral transmission takes place until a keypad key is pressed. NOTE: Low battery trouble is cleared by arming and disarming the panel.
- 2- AC POWER FAILURE... There is no audible annunciation on AC power failure. The system trouble light will come on but the audible will not sound until there is a low battery condition. Transmission delay can be programmed from 1 to 99 minutes. See Programming Guide section [16].
- 3- FOIL LOOP TROUBLE... This trouble applies only to zones which have been programmed as foil loops (PROGRAMMING GUIDE section 12). A foil loop creates a trouble signal during the day when the panel is disarmed and an alarm signal at night when the panel is armed.
- 4- TELEPHONE LINE TROUBLE... A telephone line trouble is generated when the line voltage drops below 3 volts for more than 30 seconds. It generates a keypad trouble during the day and rings a local alarm at night when the panel is armed.
- 5- UNSUCCESSFUL COMMUNICATION... If the digital communicator is unsuccessful at communicating with the monitoring station after a maximum number of attempts, a trouble is generated. If a later attempt to communicate is successful the trouble is cleared.
- 6- BELL CIRCUIT FAILURE... If the bell fuse is blown or the bell circuit is open, a keypad trouble and a trouble transmission are generated.
- 7- SMOKE DETECTOR LOOP TROUBLE... If a FIRE loop is open circuit, a keypad trouble and a trouble transmission are generated. A trouble on the FIRE loop will unconditionally initiate an audible keypad trouble. This means that even if any other previous trouble has been silenced, a FIRE loop trouble will restart the buzzer.
- 8- LOSS OF INTERNAL TIME... When the PC2500 is powered up or reset, the internal time of day clock needs to be set to the correct time. This trouble is cleared when the trouble display is viewed and exited or when an attempt is made to reset the internal time of day clock. See [*][6] USER FUNCTION COMMAND for resetting time of day clock.

NOTE:

If the [9] is pressed while in the trouble display mode the most recent trouble will be displayed on the zone LEDs. This trouble memory feature is most useful as a diagnostic aid when installing and servicing the PC2500.

ALARM MEMORY DISPLAY: [*]+[3]

Press [*] then [3] to enter the alarm memory mode. The 'MEMORY' light will flash and any alarm caused during the last armed period will be displayed on the zone lights. In addition to the last alarm memory there are 2 history levels. After entering the memory mode (pressing [*] then [3]), pressing [9] will cause the keypad to display the two other levels of alarm history. Each time [9] is pressed the keypad will beep 1, 2 or 3 times to indicate which level of history is being viewed. When the panel is armed, the last alarm memory is cleared and the contents moved to the 1st history level. The "MEMORY" light will only be on when there was an alarm during the last armed period.

Press [#] to return to 'READY'.

SWITCHED AUXILIARY SUPPLY CONTROL: [*]+[Hold Down 4]

To interrupt the switched auxiliary power supply press [*] then hold down [4] for the desired interrupt time. When the [4] is released the system returns to the ready mode and the switched auxiliary supply is restored.

USERS' PROGRAMMING COMMANDS: [*]+[5]+[Master Code]

The [*] [5] users' programming command is used to program additional user codes. Up to 8 user arm/disarm codes may be programmed. The 1st code is the master code (factory default [1234]). The 8th code is optionally a "one time use" or maid code. The 8th code may be changed from a "one time use" code to a regular code using an installers programming command (section 13...1st system definition code). Remember if no keypad

entry is made for more than 2 minutes the keypad will return to the normal arm/disarm display and the complete command will have to be re-entered to program a new user code.

PROGRAMMING ADDITIONAL USER CODES

- 1: Press the [*] and [5] keys then enter the master security code (default [1234]) to enter the additional code programming mode. The "PROGRAM" light and "Zone 1" light will be on to show that first code (the master code) is already programmed with the factory default code [1234]. The master code may be changed but do not try to erase the master code.
- 2: Seven additional codes may be programmed. The zone lights are used to indicate which of these codes are already programmed (zone light on steady) and the one which is currently being programmed (zone light is flashing).
- 3: To program the second code, press [2] then enter a 4 digit code. Zone 2 light will flash and sounder will beep after pressing [2]. Keypad sounder will beep three times and zone light will come on steady after the 4 digit code is entered.
- 4: To remove the second code, press [2] then enter [*],[*],[*],[*]. Zone 2 light will flash and the sounder will beep after pressing [2]. After pressing [*],[*],[*],[*] the sounder will beep three times and zone 2 light will go out to show that the code has been removed.
- 5: Follow the instructions in 3: or 4: for programming or removing any of the other additional codes.
- 6: Do not try to remove the master code (1st code). The master code may be changed but it can not be removed. When changing the master code be sure to enter a valid 4 digit number (use only number keys 0 to 9). Do not enter [#] or [*] as one of the digits. If the master code is forgotten and the panel is left disarmed, program a new master code using the [*][8][Installer Code][19] command. If the Master code is forgotten and the panel is left armed, the EEPROM must be removed from the panel, a blank or master EEPROM copied into the panel using the [*][8][2500][50] command. Note the default Installer Code [2500] was used for a blank EEPROM. If a master EEPROM is used, the Installer code programmed into the master must be used if it is different from [2500].
- 7: To successfully program or remove additional codes, the panel must be put into the code program mode by following step one followed by steps 3 or 4. Note that if no key entry is made for 2 minutes the panel will go back to the normal arm/disarm mode. After which step one must be repeated to get back into the code program mode.
- 8: To exit the code program mode press [#].

To review:

programming a new code;
enter [*],[5],[master code],[2 to 8],[4 digit code].

eliminating an existing code;
enter [*],[5],[master code],[2 to 8],[****]

USER FUNCTIONS COMMAND [*]+[6]+[MASTER CODE]...

This command is used to set the system clock time and to set the auto arm times. It is also used to turn on and off a number of system functions. The command is used by entering [*], [6], [MASTER CODE] then a number from the following list to select the item to be changed.

[1] System 24 hour clock (enter HH:MM)

[2] Auto arming time (enter HH:MM)

[3] NOT USED

[4] Quick arm enable/disable

[5] Auto arm enable/disable

[6] Door chime enable/disable

NOTE:

The system clock is a 24 HR. clock and times must be entered as two digit numbers.

e.g. HH - 01,02,....10,11,....23,24

MM - 00,01,....35,36,....58,59

[7] NOT USED

[8] Bell test function

[0] Zone test function

The first three items are time setting functions. Enter 4 digits representing the time in hours and minutes (HH:MM) based on the 24 hour or military clock. Always enter a leading zero where only one digit is required. 8:05 AM would be entered as 0805. 1:30 PM would be entered as 1330. Items [4] to [7] turn on and off various features. When the item key is pressed, the feature is turned on if the keypad beeps quickly 3 times. The feature is turned off if the keypad sounds one long beep. Pressing item [8] gives a 2 second bell and keypad light test.

SETTING THE CLOCK [*]+[6]+[MASTER CODE]+[1]

Setting the "System 24 Hour Clock" (item [1]) simply tells the system the correct time of day. If the system is without battery and AC power it cannot continue to keep time. Therefore when the panel is first powered up or when it has been without AC power long enough to completely discharge the standby battery the "System 24 Hour Clock" must be reset. If the time needs to be reset a "Trouble #8" will be indicated on the keypad (see [*][2] system trouble command).

AUTO ARM [*]+[6]+[MASTER CODE]+[2]

The PC2500 can be programmed to arm at the same time each day. Programming item [2] sets this time. At the selected auto-arm time the keypad beeper begins to sound to alert anyone on the premises that the system is about to arm. One minute later the system will arm. If any key on the keypad is pressed during the time that the keypad is beeping, the auto arming will be aborted. Auto arming will be attempted at the same time the next day. Besides setting the times for auto arm this feature must be enabled (enabled 3 beeps...disabled one long beep) using the [5] and [7] key while in the "USER FUNCTIONS COMMAND".

QUICK ARM [*]+[6]+[MASTER CODE]+[4]

The "Quick Arm" feature is enabled by pressing the [4] key while in the "USER FUNCTIONS COMMAND". When enabled (enabled 3 beeps...disabled one long beep) the panel can be armed by entering [*][0]. The closing code transmitted for "Quick Arm" is the same as the code which is programmed for the master code.

DOOR CHIME [*]+[6]+[MASTER CODE]+[6]

The "Door Chime" feature is enabled by pressing the [6] key while in the "USER FUNCTIONS COMMAND". When enabled the keypad sounder will beep quickly 5 times each time any zone defined as a delay or instant circuit opens or closes. The "Door Chime" feature does not operate on other zone definitions. Zone by-pass may be used to eliminate "beeping" on doors where it is not wanted. This feature operates only while the panel is disarmed.

INSTALLER'S TEST [*]+6+[MASTER CODES]+0

The INSTALLER'S TEST may be enabled when in the "USER FUNCTION COMMAND" by pressing the [0] key. The keypad sounder will give 3 quick beeps when the function is enabled and one long beep when disabled. This feature facilitates the final testing of an installation by causing the siren or bell to operate for two seconds whenever a zone is put into alarm. The bell/siren will respond to all zone inputs regardless of how they are defined in the program. To exit the INSTALLER'S TEST MODE, arm then disarm the panel in quick succession. The communicator will send test transmissions during the testing unless it has been disabled.

BELL TEST [*]+[6]+[MASTER CODE]+[8]

The bell test feature sounds the bell or siren, lights the keypad indicators and beeps the keypad sounders for 2 seconds.

UTILITY OUTPUT COMMAND [*]+[7] or [*]+[7]+[USER CODE]

The programmable output (PGM terminal) on the PC2500 can be made to activate by a command from the keypad. This output can be used for operating other devices such as; garage door opener, special lighting or door strikes.

The programmable output must be selected for keypad utility using the [*][8][Installer Code][22] command and programming items [2],[3],[4] or [5].

Depending on the option chosen in the programming section, the programmable output is activated by pressing the [*] then [7] keys followed by a Group A access code, Group B access code, any access code or no code at all. When the proper keys are pressed the keypad sounder and the programmable output are activated for 2 seconds.

INSTALLERS' PROGRAMMING COMMANDS [*]+[8]+[INSTALLER CODE]

The PC2500 is completely programmed from the keypad by using commands in the [*] [8] section. The commands are described in detail in the programming section of this manual.

"AT-HOME" ARMING COMMAND [*]+[9]+[USER CODE]

Entering [*] [9] before the arming code arms the panel without any entry delay on the delay zones. This command is used for arming the system while at home. The armed LED will flash while the panel is in the "at-home" armed mode.

"QUICK-ARM" COMMAND [*]+[0]

Entering [*] [0] is accepted as a valid arming code when the "QUICK-ARM" feature is activated. This command is often used when individuals are required to arm the system but it is not wanted that they be able to disarm the system. This could be used with home visitors in the case of a residential alarm or junior employees and maintenance staff in the case of a commercial alarm. See instructions in the "[*][6] USERS' PROGRAMMING COMMANDS" section for activating the "QUICK-ARM" feature.

KEYPAD ZONES

There are three zones which can be activated from the keypad. The alarm and restoral codes for keypad zones are programmed using the [*] [8] command.

Pressing the [1] and [3] keys at the same time activates a fire alarm. The fire alarm sounds the siren/bell in a pulsed mode and is annunciated as a memory condition.

Pressing the [4] and [6] keys at the same time activates an emergency keypad zone. If a reporting attempt is made to an alarm receiver and it is successful the P2500 will acknowledge the transmission with a short series of beeps from the keypad.

Pressing the [*] and [#] keys at the same time activates the Police (or Panic) alarm. The panic alarm can be programmed for audible or silent operation (see section [13] in PROGRAMMING GUIDE).

There is no light annunciation from the keypad for the last two keypad zones, however, the keypad buzzer beeps 3 times to confirm activation on any of the keypad zones. If the keys are held down the buzzer continues to beep.

See section [11] for alarm and restoral codes for all three keypad zones.

NOTE: The [1] and [3] keypad activated zone should be used for FIRE only.

PROGRAMMING GUIDE

INTRODUCTION

The PC2500 is programmed by entering instructions from the panel keypad. The PC2500 memory is EEPROM and can be reprogrammed thousands of times. The EEPROM will not lose memory even on total AC and battery failure. All essential program information required to define the operation of the control panel and the communicator is stored in a section of the EEPROM which can only be accessed using the installers' programming code. If the code is forgotten the panel can be programmed using a blank EEPROM or Master EEPROM using the instructions in section [50].

To begin programming the PC2500, enter [*],[8],[2500] while the panel is disarmed. Installer programming can only be done while the panel is disarmed. The factory default installers' program code is 2500. This default code can be changed using the section 18 command listed below (new installers' code). Once the basic installer command is entered ([*],[8],[2500]) the program light will start to flash. The program light will continue to flash while programming. Note that while programming, if no key entry is made for more than 2 minutes the keypad will return to the normal arm/disarm condition and the complete installers command ([*],[8],[2500]) must be entered before programming can resume.

The next step is to enter a 2 digit section entry for any of the commands described in the following pages. Note that while the keypad is waiting for the section entry the armed light is on steady. As soon as the 2 digits are entered for the section the keypad will beep 3 times, the arm light will go out and the ready light will go on. The keypad is then ready to accept data entry for the selected section.

A complete description of each programming section will be given in the remaining pages of this section. A programming work sheet summarizing all programming commands is provided in the next section of the manual. Fill out the work sheet and use it as a guide when programming.

As the required data for a programming section is entered, the binary value of the last data entry is displayed on zone lights 1-8. Most sections contain several groups of two digit entries. The keypad beeps twice and the armed light flashes after each group of two digits is entered. When the required data is completely entered for the section being programmed, the keypad will beep five times and the armed light will come back on to indicate that the expected data has been entered and another section can be selected for programming. After completing one section, it is not necessary to re-enter the [*] [8] [installers' code] portion of the command. Just enter the number of another programming section. When programming a section, it is possible to exit by pressing [#]. Only the data entered before pressing [#] will be changed in the EEPROM. Practice entering data in several sections until you become familiar with the programming commands.

Certain programming entries may require "HEX" data. That is the numbers 0 through 9 and the letters A through F (in "HEX" numbering the letters A...F represent the numbers 10...15). Where commands require "HEX" data A-F, first press [*]. The keys 1-6 now assume the hex values A-F and the ready light begins to flash. Key 1=A. Key 2=B. Key 3=C. Key 4=D. Key 5=E. Key 6=F. Pressing the [*] again stops the ready light from flashing and the keys assume the normal values for the numbers from 1-9. The most common mistake in entering "HEX" data is forgetting to press [*] again after entering the "HEX" digit to return to normal number entry.

The data for sections 13,14,15,23,24,25 and 26 are entered using the keypad zone lights to indicate which functions are active and the number keys to turn functions on and off. When the section number is entered, the zone lights 1...8 will display which functions are currently on. Pressing the number key corresponding to the zone light alternately turns the function on and off. All functions can be turned off by entering [0]. When the correct selections have been made press [#] to record them in memory and to go on to program the next section.

[00] BINARY PROGRAMMING

This section is normally used upon instruction from factory technical personnel for specialized programming not covered by the standard programming instructions. Binary programming expects a 3 digit decimal

address followed by a 2 digit HEX value for data. After entering the 2 digit HEX data the address is incremented to the next address. Exit binary programming by pressing [#]. Press [#] again to return keypad to normal arm/disarm condition.

[01] 1st PHONE NUMBER (Communicator)

This is the 1st telephone to which the communicator will dial. See section "[27] TRANSMISSION TO 1ST OR 2ND TELEPHONE NUMBER OPTIONS". After entering the section number [01], enter the communicator telephone number the way you would dial it on a telephone. Press [#] after the last digit to complete the telephone number programming. A second dial tone search, as required in a PBX system, can be added by programming "HEX D" between the digits in the phone number where it is required. To do this press [*] to change to HEX entry, press [4] which now represents "HEX D" and press [#] again to return to normal number entry. Instead of a second dial tone search; a pause of 2, 4 or 8 seconds can be inserted between digits in the telephone number by entering "HEX B", "HEX C" or "HEX E". The total number of digits including dial tone searches and pauses must not exceed 16. Remember to press [#] after entering the last digit of the phone number. Press [02] to program the next section, enter another section number or press [#] a second time to return to the arm/disarm mode.

[02] 1st ACCOUNT CODE (Communicator)

The 1st account code is always transmitted to the 1st phone number to identify the alarm customer. After entering the section number [02], enter a 4 digit number. If "HEX" digits A to F are required; enter [*], [1]...[6] and [#] again to return keys to normal decimal entry. Where a zero digit in the account code is required use "HEX A" ([*][1][*]) to transmit 10 pulses. The receiver at the monitoring station interprets 10 pulses for a digit as a zero. If a three digit code is required, as in 3/1 formats, enter [0] as the last digit. [0] represents a null digit...no pulses transmitted.

[03] 2nd PHONE NUMBER (Communicator)

This is second telephone number to which the communicator will dial. See [01] 1st phone number for programming instructions.

[04] 2nd ACCOUNT CODE (Communicator)

The 2nd account code is always transmitted to the 2nd phone number. See [02] 1st account code for programming instructions.

[05]...[11] REPORTING CODE EXPLANATION

Sections [05] to [11] are used to program the communicator reporting codes. A reporting code is transmitted along with the account code with each transmission. If the reporting codes are not programmed in these sections no transmission will be sent when an event (i.e. alarm, restoral, opening/closing, trouble etc.) takes place. To prevent a transmission from being sent for any event in the following sections leave it unprogrammed ("HEX FF") or enter [00] as the reporting code.

Eight reporting codes are programmed in each section. Once the section code is entered, the keypad expects 8 two digit numbers to be entered for the 8 reporting codes in that section. The keypad beeps twice and the armed light flashes after each 2 digit number is entered. After the 8th code is entered, programming of the current section is complete. The keypad will beep 5 times, the "READY" light will go off and the "ARM" light will go on. The keypad is then ready to accept the next section number for programming.

When changing the reporting codes in a section, only code entries up to the one which is being changed need be entered. Press [#] to exit from the programming sequence. Only codes up to the last one entered will be changed.

[05] ALARM REPORTING CODES Zones 1 TO 8 (Communicator)

Once the section code [05] is entered, the keypad expects 8 two digit numbers to be entered as the reporting codes for zones 1 to 8 alarms (restorals in section [06]). These codes are used by the communicator when there has been an alarm on zones 1 to 8. Listed below are several programming examples and the resulting transmission using different formats for the reporting codes. Obtaining different formats requires entering data correctly in the account code ([02]or[04]) section, reporting codes ([05]to[11]) section and communication format ([21]) section.

3/1 FORMAT...SINGLE LINE OR NON-EXTENDED REPORTING

- Required: -3 digit account code in sections [02] or [04]
i.e. enter [1230] for account code 123
-Format code [0],[1],[2],[3],[4] depending on receiver type in section [21]
-Single digit alarm reporting code in section [05]
i.e. enter [30] for single digit code 3 (0 is null digit i.e. no pulses transmitted)

Transmission sent: - 123 3

4/2 FORMAT...SINGLE LINE REPORTING

- Required: -4 digit account code in sections [02] or [04]
i.e. enter [1234] for account code 1234
-Format code [0],[1],[2],[3],[4] depending on receiver type in section [21]
-Two digit alarm reporting code in section [05]
i.e. enter [31] for two digit code 31

Transmission sent: - 1234 31

3/1 FORMAT...EXTENDED REPORTING

- Required: -3 digit account code in sections [02] or [04]
i.e. enter [1230] for account code 123
-Format code [8],[9],[A],[B],[C] depending on receiver type in section [21]
-Two digit alarm reporting code in section [05]
i.e. enter [31]

Transmission sent: - 1st round 123 3
- 2nd round 333 1

4/1 FORMAT...EXTENDED REPORTING

- Required: -4 digit account code in sections [02] or [04]
i.e. enter [1234] for account code 1234
-Format code [8],[9],[A],[B],[C] depending on receiver type in section [21]
-Two digit alarm reporting code in section [05]
i.e. enter [31]

Transmission sent: - 1st round 1234 3
- 2nd round 3333 1

If a transmission is not wanted for a particular reporting code, enter 00 or FF to disable that reporting code.

[06] RESTORAL REPORTING CODES ZONES 1 TO 8 (Communicator)

These reporting codes are used by the communicator to transmit a zone restorals for zones 1 to 8. Use instructions in section [05] as a guide for programming.

[07] UTILITY ALARM REPORTING CODES (Communicator)

These reporting codes are used by the communicator to transmit the following list of alarm conditions. Use instructions in section [05] as a guide for programming.

FIRE ZONE
AC FAILURE TROUBLE
FIRE ZONE TROUBLE

AUXILIARY INPUT ZONE
FOIL ZONE(S) TROUBLE
AUX POWER SUPPLY TROUBLE

BATTERY TROUBLE
BELL CIRCUIT TROUBLE

See "TERMINAL CONNECTIONS" section of manual for a description of the operation of the FIRE ZONE and the AUXILIARY INPUT ZONE. Section [22] contains options for AUXILIARY INPUT ZONE. The BATTERY TROUBLE reporting code will be sent when the battery voltage drops below 11.5 volts. This reporting code will also be sent because of a battery fuse failure. The battery is tested under load every 10 seconds. Only one transmission will be sent during an arm or disarm period to prevent multiple transmissions from a weak battery. The AC FAILURE TROUBLE reporting code will be sent after the delay time programmed in section [16]. This prevents transmissions during temporary power failures. AUXILIARY POWER SUPPLY TROUBLE reporting code is sent when the auxiliary power supply fuse is defective. The BELL CIRCUIT TROUBLE reporting code is sent when the bell circuit is open or the fuse is defective. The FIRE ZONE TROUBLE code is sent when the fire zone becomes open circuit (E.O.L. resistor is disconnected). The FOIL ZONE TROUBLE code is sent when any zone defined as a foil loop (see section [12]) goes into alarm during the day when the system is disarmed. See [*][2] TROUBLE COMMAND for additional description of trouble codes and transmissions.

[08] UTILITY RESTORAL REPORTING CODES (Communicator)

These reporting codes are used by the communicator to transmit the following list of restoral conditions which correspond to alarm conditions in section [07]. Use instructions in section [05] as a guide for programming.

- FIRE ZONE
- AUXILIARY INPUT ZONE
- BATTERY TROUBLE
- AC TROUBLE
- FOIL ZONE(S) TROUBLE
- BELL CIRCUIT TROUBLE
- FIRE ZONE TROUBLE
- AUX POWER SUPPLY TROUBLE

[09] REPORTING CODES FOR CLOSING (ARMING) VIA USER CODES 1 TO 8

The reporting codes in sections [09] and [10] are used to identify "OPENINGS AND CLOSINGS" (disarming and arming of the system) by user access code.

After entering the section code [09], enter 8 two digit reporting codes. The 8 reporting codes correspond to the 8 user access codes which are programmed using the [*][5] command. When the system is armed using one of the user access codes, the corresponding reporting code is transmitted.

When transmitting in 4/2, 3/1 extended or any of the other extended formats (see examples in section [05]); the 8 closing codes are programmed as follows.

[C1],[C2],[C3],[C4],[C5],[C6],[C7],[C8]

Where the first digit "HEX C" is one which is used to represent a closing signal (this could be another number depending on what is used at the monitoring station) the 2nd digit represents the user access code which was used to arm the system.

The closing code transmission takes place after the exit delay time. Therefore if the system is armed and disarmed before the expiry of the exit time, no closing transmission will take place.

Remember that the 1st user access code is the master code and that the 8th code is the temporary or maid's code. The 8th user code can be converted to a normal code using one of the options of the system definition code in section [13].

When the system has been armed using "QUICK ARM" [*][0] or "AUTO ARM" (see [*][6] keypad commands), the 1st reporting code (reporting code for master code) will be transmitted. The master code has control over whether these functions are enabled or disabled.

When the system is armed with one or more zones by-passed (see [*][1] command for zone by-passing), the monitoring station can be notified by programming the PARTIAL ARM reporting in section [11]. Note that the PARTIAL CLOSING code is sent in tandem with the regular closing code to identify it as a partial closing condition.

[10] REPORTING CODES FOR OPENINGS (DISARMING) VIA USER CODES 1 TO 8

The 8 reporting codes correspond to the 8 user access codes which are programmed using the [*][5] command. When the system is disarmed using one of the user access codes, the corresponding reporting code in this section is transmitted.

See section [09] for an example of "OPENING AND CLOSING" reporting code programming.

[11] REPORTING CODES FOR MISCELLANEOUS FUNCTIONS

The reporting codes programmed in this section include the partial arm code described in section [10], alarm and restoral codes for the keypad zones and the periodic test reporting code (every 1 to 99 days). The periodic test cycle time is set in section [16] and reporting time of day is set in section [17].

The reporting codes are programmed in the following order.

PARTIAL CLOSING

KEYPAD PANIC ALARM [*][#]

KEYPAD FIRE ALARM [1][3]

KEYPAD EMERGENCY ALARM [4][6]

KEYPAD PANIC RESTORAL [*][#]

KEYPAD FIRE RESTORAL [1][3]

KEYPAD EMERGENCY RESTORAL [4][6]

PERIODIC TEST TRANSMISSION

[12] ZONE DEFINITION FOR ZONES 1 TO 8 (Control Panel)

As in the reporting codes, once this section number is entered 8 two digit numbers are required. Each 2 digit number entered describes how a zone will operate. The 8 two digit numbers entered correspond to zone definitions for zones 1 to 8.

The first digit entered determines whether the zone will be audible or silent and fast or slow response time (loop response time is programmed in section [16]). The second digit determines the type of zone (i.e. delay, instant, interior, or 24 hour zone).

1ST DIGIT

- 0= AUDIBLE, SLOW(normal)
- # 1= SILENT, SLOW(normal)
- 2= AUDIBLE, FAST
- # 3= SILENT, FAST

* The maximum delays allowed for U.L. installations are: Entry delay = 45 sec.
Exit delay = 60'
Not allowed for U.L. Local installations

2ND DIGIT (Zone Type)

- 0= DELAY LOOP
- 1= INSTANT LOOP
- 2= INTERIOR LOOP (follower)
- 3= INTERIOR LOOP WITH HOME AWAY
- 4= 24 HOUR LOOP (Bell Day or Night)
- 5= 24 HOUR LOOP (Bell-Night/Buzzer-Day)
- # 6= 24 HOUR LOOP (Buzzer Day and Night)
- * 7= DELAY LOOP (2x Normal Entry Delay)
- * 8= DELAY LOOP (4x Normal Entry Delay)
- 9= FOIL LOOP

FACTORY PROGRAMMED (DEFAULT)

ZONE		
1	0	0
2	0	1
3	0	1
4	0	1
5	0	2
6	0	2
7	0	2
8	0	4

All of the zone types, except the 24 hour loops and foil loop, have an exit delay (see section [16] for setting exit and entry delay times). All zones with an exit delay may be passed through during the exit delay without creating an alarm.

If you are not familiar with the different loop types, test them to see how they function. To avoid confusion, be sure exit time has expired before creating alarms (READY light will go out when exit time has expired). Set short exit and entry times for testing.

The type [0] delay loop is used for the exit/entry door. It has an exit delay and an entry delay. The exit delay starts as soon as the panel is armed. The loop may be opened and closed during the exit delay without creating an alarm. After the exit delay has expired, an open on the loop will cause the entry delay time to start. During the entry time the keypad buzzers will sound steady. If the panel is disarmed before the entry time expires no alarm will be generated. Type [7] and [8] delay loops are used where a longer entry delay time is required such as with a garage door. With these two loop types the exit delay is the same as the type [0] delay. However, the entry delay times are either 2 or 4 times as long (set the exit delay time for the maximum required).

The type [1] instant loop is normally used for door and window contacts. This loop has a normal exit delay but will generate an alarm immediately when opened after the exit delay.

The type [2] INTERIOR and type [3] INTERIOR WITH HOME-AWAY loops are used with interior motion detectors. Both loops have standard exit delays. They also have entry delays provided that a delay loop has been tripped first. If the building is entered without coming through the normal delay entrance and a type [2] or [3] loop is tripped, an immediate alarm will be generated. The type [3] loop is by-passed if the system is armed using the [*][9] command (at home arming) or if a DELAY zone is not tripped during the exit delay.

The type [4], [5] and [6] 24 HOUR loops provide different variations on the audible device. 24 Hour loops are active and create an alarm whether or not the panel is armed. Type [4] always rings the bell. Type [5] rings the bell at night and the keypad buzzer during the day. Type [6] always sounds the keypad buzzer.

The type [9] FOIL LOOP is a variation of a 24 hour circuit. It operates as a type [5] loop by ringing the bell at night and the keypad buzzer during the day (2 beeps every 10 seconds pressing any key silences keypad buzzer). However, a trouble transmission (programmed in section [08]) is sent when the system is disarmed rather than an alarm transmission (programmed in section [05]).

[13] 1ST SYSTEM OPTION CODE

The first system option code is set using the zone lights to indicate which options in the following list are active. The keypad buttons are used to turn the options "on" or "off". Once section [13] is entered, the eight zone lights will immediately indicate the status of the "1st system options". Press the appropriate key, [1] thru [8], to turn the option "on" or "off". To turn ALL options OFF, press [0].

- [1] LIGHT ON = DISABLE COMMUNICATIONS
- LIGHT OFF = ENABLE COMMUNICATIONS

- [2] LIGHT ON = ALARM RESTORAL REPORTING ON BELL TIMEOUT
LIGHT OFF = ALARM RESTORAL REPORTING ON DISARM
(One alarm and one restoration signal is transmitted from each zone that is tripped during any armed period)
- [3] LIGHT ON = DISPLAY ZONES IN ALARM WHILE PANEL ARMED
LIGHT OFF = DO NOT DISPLAY ZONES IN ALARM WHILE ARMED
- [4] LIGHT ON = DTMF OR TOUCH TONE DIALLING
LIGHT OFF = PULSE OR ROTARY DIALLING
(When set for DTMF dialling, the panel will default to pulse dialling after two unsuccessful DTMF attempts)
- [5] LIGHT ON = ZONES 1 TO 8 NORMALLY CLOSED LOOPS
LIGHT OFF = ZONES 1 TO 8 END-OF-LINE RESISTOR SUPERVISED
- [6] LIGHT ON = KEYPAD PANIC [*][#] IS AUDIBLE
LIGHT OFF = KEYPAD PANIC [*][#] IS SILENT
- [7] LIGHT ON = BECOMES CALL 1ST PHONE NUMBER ONLY
LIGHT OFF = CALL 1ST PHONE WITH BACKUP TO 2ND PHONE (see section [27])
- [8] LIGHT ON = 8TH CODE IS MAID'S CODE (TEMPORARY CODE)
LIGHT OFF = 8TH CODE BECOMES NORMAL USER ACCESS CODE
(User access codes are programmed with [*][5] command)

[14] 2ND SYSTEM OPTION CODE

Programmed using the same method as section [13].

- [1] LIGHT ON = PANEL OPERATION ON 50 HZ. POWER
LIGHT OFF = PANEL OPERATION ON 60 HZ. POWER
- [2] LIGHT ON = FIXED MASTER CODE
LIGHT OFF = CHANGEABLE MASTER CODE
- [3] LIGHT ON = BELL SQUAWK OPTION ON
LIGHT OFF = BELL SQUAWK OPTION OFF
(when on, this option sounds the bell briefly once when the panel is armed and twice when disarmed.)
- [4] LIGHT ON = OUTPUT MODULE ACTIVE
LIGHT OFF = OUTPUT MODULE NOT ACTIVE
- [5] LIGHT ON = TLM SILENT
LIGHT OFF = TLM AUDIBLE
- [6] LIGHT ON = 1400 HZ. RADIONICS
LIGHT OFF = 2300 HZ. RADIONICS
- [7] LIGHT ON = TLM DISABLED
LIGHT OFF = TLM ENABLED
- [8] LIGHT ON = USER CODE REQUIRED FOR SHUNTING
LIGHT OFF = USER CODE NOT REQUIRED FOR SHUNTING

[15] ZONES 1 TO 8 BY-PASS (SHUNT) MASK (Control Panel)

Use the same method of programming as used in section [13]. Using this section it is possible to control which zones the user is able to by-pass using the [*][1] command. If the zone light is on the zone can be by-passed. If the zone light is off that zone cannot be by-passed.

[16] SYSTEM TIMES (Control Panel and Communicator)

Once the section number is entered 6 two digit numbers are expected to be entered. The valid range for entries in this section is 01 to 99. Hex values are not allowed. The times are entered in the following order.

ENTRY DELAY TIME (IN SECONDS)
EXIT DELAY TIME (IN SECONDS)
BELL CUT OFF TIME (IN MINUTES)
DELAY BEFORE AC FAILURE TROUBLE REPORTING (IN MINUTES)
SLOW LOOP RESPONSE TIME (IN 10 msec INCREMENTS)
TEST TRANSMISSION CYCLE TIME (IN DAYS)

Up to a 99 minute delay may be programmed before the AC FAILURE reporting code is transmitted. The reporting code for AC FAILURE TROUBLE is programmed in sections [7] and [8].

The loop response time is the length of time that an alarm condition must be present on a loop before it is detected. Certain vibration detectors, shock sensors and glass break detectors require a fast response loop in order to operate. The loops to which these types of detectors are connected should be programmed as fast response loops. All other loops should be programmed as slow response loops. Loops are defined as either fast or slow response time in section [12]. The fast response time is fixed at 10 milliseconds. The SLOW LOOP RESPONSE TIME is programmable in increments of 10 milliseconds. The normal entry would be 20 for a 200 msec slow response time.

The test transmission sent to the monitoring station on a regular basis to confirm that the communication link to the system is intact. The TEST TRANSMISSION CYCLE TIME is how often (in days) the test transmission is sent. The reporting code for the test transmission is programmed in section [11]. The time of day that the test transmission is sent is programmed in section [17].

[17] SYSTEM CLOCK TIMES

After the section number [17] is entered. 3 four digit numbers are expected. These numbers are the following system times.

AUTOMATIC ARMING TIME OF DAY (HH:MM)
TEST TRANSMISSION TIME OF DAY (HH:MM)

Times are entered using the "24 hour clock" (military time). Valid entries are 00 to 23 for HH (i.e. hours) and 00 to 59 for MM (i.e. minutes). NOTE: IF INVALID TIMES ARE ENTERED FUNCTIONS WILL NOT WORK. The automatic arm function is enabled and disabled using the [*][6][MASTER CODE] USER PROGRAMMING COMMAND. The installer can totally disable the auto arm function and therefore not make it available to the end user by entering an invalid time such as 99:99 for HH:MM.

[18] NEW INSTALLER'S CODE

[19] NEW MASTER CODE (1ST USER ACCESS CODE)

Enter a new 4 digit code in each of the sections above once the section number has been entered. Only use digits 0 to 9 as code numbers. Do not press the [*] or [#] keys. If an error is made in entering a code, continue to enter the four digits then enter the section number again and re-enter the correct code. Do not press the [*] or [#] while entering these codes. Do not make any of the two codes the same.

[20] FUTURE USE - Do not enter section [20]

[21] COMMUNICATOR FORMAT OPTIONS

This section sets the type of format which will be sent to each of the two telephone numbers programmed in sections [1] and [3]. Enter one HEX digit (i.e. when entering HEX A press [*][1][*]) for each. The number entered for each phone number is determined by the type of receiver being called. Enter the format number

for the "1st TELEPHONE NUMBER" first. It is necessary to program both format numbers for each telephone number even if the first phone number is the only one being used. Options are as follows.

- [0] SILENT KNIGHT/ADEMCO SLOW, 10 BPS (1400HZ HANDSHAKE) 3/1, 3/2 AND 4/2 NON EXTENDED FORMAT
- [1] SESCOA, FRANKLIN, DCI, VERTEX, 20 BPS (2300HZ HANDSHAKE) 3/1, 3/2 AND 4/2 NON EXTENDED FORMAT
- [2] SILENT KNIGHT FAST, 20 BPS (1400HZ HANDSHAKE) 3/1, 3/2 AND 4/2 NON EXTENDED FORMAT
- [3] RADIONICS, (2300/1400HZ HANDSHAKE) 3/1, 4/2 NON EXTENDED FORMAT
- [4] RADIONICS, (2300/1400HZ HANDSHAKE) 3/1, 4/2 NON EXTENDED WITH PARITY FORMAT
- [5] NOT USED
- [6] NOT USED
- [7] FOR FUTURE USE
- [8] SILENT KNIGHT/ADEMCO SLOW, 10 BPS (1400HZ HANDSHAKE) 3/1 EXTENDED FORMAT
- [9] SESCOA, FRANKLIN, DCI, VERTEX, 20 BPS (2300HZ HANDSHAKE) 3/1 EXTENDED FORMAT
- [A] SILENT KNIGHT FAST, 20 BPS (1400HZ HANDSHAKE) 3/1 EXTENDED FORMAT
- [B] RADIONICS, (2300/1400HZ HANDSHAKE) 3/1 EXTENDED FORMAT
- [C] RADIONICS, (2300/1400HZ HANDSHAKE) 3/1 AND 4/1 EXTENDED WITH PARITY FORMAT
- [D] FOR FUTURE USE
- [E] FOR FUTURE USE
- [F] FOR FUTURE USE

10 BPS AND 20 BPS FORMATS

10 BPS is the standard slow format used on Silent Knight/Ademco receivers. DATA=1900HZ. KISSOFF=1400HZ. SPEED=10 BAUD.

20 BPS is the standard fast format used on DCI, Franklin, SESCOA and Vertex receivers. DATA=1800HZ. KISSOFF=2300HZ SPEED=20 BAUD.

RADIONICS FORMAT

For conventional 3/1 Radionics format the communications mode should be set to either Radionics rounds [B] or Radionics parity [C]. The extended version of the Radionics format is normally used. The following guidelines have been provided to help in configuring the PC2500 for Radionics format.

1. The customer account code must be only 3 digits with a zero making up the 4th digit (i.e. program 1230 for account code 123).
2. The zone alarm reporting codes must all be single digit numerical codes with no extended 2nd round being sent. (i.e. ZONE 1=10, ZONE 2=20, ZONE 3=30....ZONE 8=80) The zero in the 2nd digit of the reporting code tells the PC2500 not to send an extended round.
3. All other non-alarm reporting codes must be set up to send an extended 2nd round. The 1st digit of the reporting code is used to identify the event while the 2nd or extended digit is used to associate the event with a particular item. (i.e. A reporting code of E3 means restore zone 3. E for restore and 3 for zone 3.)
4. The following is a list of 1st digit identifiers that should be used with the Radionics format.

RESTORALS	"E"	EXAMPLE "E3" = RESTORE ZONE 3
OPENINGS	"B"	EXAMPLE "B2" = OPENING BY USER 2
CLOSINGS	"C"	EXAMPLE "C4" = CLOSING BY USER 4
TROUBLES	"F"	EXAMPLE "F5" = TROUBLE FROM SOURCE 5
MISC	"D"	EXAMPLE "D1" = PARTIAL CLOSING

[22] PROGRAMMABLE INPUT AND OUTPUT OPTIONS

Both the Auxiliary Input Zone and the Programmable Output have options which are programmed in this section. After the section number [22] is entered, enter 2 HEX digits from the following lists to program them.

AUXILIARY INPUT ZONE (1st digit)

- [0] DO NOT USE
- [1] SILENT 24 HOUR INPUT
- [2] AUDIBLE 24 HOUR INPUT
- [3] MOMENTARY ARMING INPUT

See Auxiliary Input Terminal in the TERMINAL CONNECTIONS section for details on the Auxiliary Input. When option [3] is selected for Key Arming, a momentary key closure between the Auxiliary Input and the Positive Auxiliary Power Supply will alternately arm and disarm the system. The reporting codes for the Auxiliary Input (section [7] and [8]) can be used as opening and closing codes for key arming.

PROGRAMMABLE OUTPUT (2nd digit)

- [0] DO NOT USE
- [1] GROUND START PULSE
- [2] UTILITY OUTPUT ([*][7]) NO ACCESS CODE
- [3] UTILITY OUTPUT ([*][7][USER CODE]) ANY ACCESS CODE
- [4] UTILITY OUTPUT ([*][7][GROUP A CODE]) GROUP A ACCESS CODE
- [5] UTILITY OUTPUT ([*][7][GROUP B CODE]) GROUP B ACCESS CODE
- [6] KEYPAD BUZZER FOLLOW MODE
- [7] SYSTEM STATUS (ARM/DISARM) OUTPUT
- [8] STROBE OUTPUT (LATCHED ALARM OUTPUT)
- [9] FAILURE TO COMMUNICATE OUTPUT

See Programmable Output Terminal in the TERMINAL CONNECTIONS section for details on connecting the "PGM OUT" terminal. Option [1] provides a 2 second ground start pulse before dialing begins to obtain the dial tone on ground start telephone equipment.

Options [2] to [5] change the "PGM OUT" terminal to different options used with the keypad UTILITY OUTPUT [*][7] command. See Utility Output command in the KEYPAD COMMAND section.

With option [6] the "PGM OUT" terminal switches to ground as long as the keypad buzzer is on.

With option [7] the "PGM OUT" terminal switches to ground when the panel is armed. The switch is open when the panel is disarmed.

With option [8] the "PGM OUT" terminal switches to ground after an alarm and remains switched on until the system is disarmed.

With option [9] the "PGM OUT" terminal switches to ground if the system fails to communicate with the monitoring station after 8 attempts. The output stays switched to ground until a successful communication takes place or until trouble #5 is cleared from the keypad. This option may be used to tie two systems together. One system can then be made to report a communication failure for the other.

SECTIONS [23][24][25][26] SPLIT ARMING/REPORTING

Split arming is a feature of the PC2500 that permits a single control panel to act as two independent alarm systems with the added option of reporting opening and closing signals by user and by system.

Split-Arming is not allowed for U.L. installations.

COMMON ZONES:

If a zone (1 thru 8 only) is assigned to both group (A) AND group (B) then both group (A) and group (B) must be armed for that zone to be armed.

COMMON ACCESS CODE:

If an access code (1 thru 8 only) is assigned to group (A) AND group (B) then that access code will arm and disarm the entire panel.

ARMED STATUS INDICATIONS:

When the panel is established as a split system, ONE side only [group (A) or (B)] is armed, the "armed" indicator will flash and the zone indicators for the group that has been armed will flash.

If both group (A) and group (B) are armed, the "armed" indicator will be on steadily and the zone lights will be OFF.

ZONE SHUNTING ACCESS CODE:

When the system is established for split arming, user zone shunting should be set so that shunting requires the use of a user access code. (see section [14])

UNASSIGNED ZONES:

If any of zones 1 to 8 are not assigned to either group (A) or group (B) then a transmission will not be sent and there will be no panel response if those unassigned zones are activated.

UNASSIGNED ACCESS CODES:

If any of access codes 1 to 8 are not assigned to either group (A) or group (B) then a transmission will not be sent and there will be no panel response if those unassigned access codes are entered.

An access code not assigned to either group (A) or group (B) will still work with the [*][7] keypad command but cannot report an opening or closing signal. (eg. code could be assigned to operate a door strike only)

COMMUNICATOR:

When the system is set up for "split arming" and both groups (A) and (B) are reporting to the same telephone number, it is suggested that the communicator call directions be programmed as follows.

1st PHONE NUMBER [01] AND 2nd PHONE NUMBER [03] are the same

1st CUSTOMER ACCOUNT CODE [02] and 2nd CUSTOMER ACCOUNT CODE [04] are different.

In section [27] group (A) zone alarms and restorals are programmed [1] to call the first number only. (see section [13] item [7])

Group (B) zone alarms and restorals are programmed (2) to call the second number only.

[27] COMMUNICATOR CALL DIRECTION OPTIONS

Programming this section tells the dialer whether to send transmissions to the 1st or 2nd telephone number.

There are three classes of dialer call direction options.

- [1] Call 1st phone number with back up to 2nd number
- [2] Call 2nd phone number only
- [3] Always call both phone numbers

Option [1] becomes call 1st number only when item [7] in section [13] is turned on (LIGHT ON).

After entering the section number, enter [1], [2] or [3] for each of the following reporting code groups in the order given (total of six digits).

ZONES GROUP A ALARMS AND RESTORALS
ZONES GROUP B ALARMS AND RESTORALS
ACCESS CODES GROUP A OPENINGS AND CLOSINGS
ACCESS CODES GROUP B OPENINGS AND CLOSINGS
PRIORITY ALARMS AND RESTORALS
MAINTENANCE ALARMS AND RESTORALS

Where all reporting codes are to be sent to one telephone number, enter [1] for all of the above classes.

[28] RESET EEPROM MEMORY TO FACTORY DEFAULTS

This section is used to reset the EEPROM memory to the original factory default values. As soon as [28] is entered the EEPROM is reset and the program is restarted as though power had just been applied.

NOTE: Sections [29] thru [49] are reserved for future use.

[50] EEPROM COPY COMMAND

NOTE: TO REDUCE PROGRAMMING TIME AND ERRORS, IT IS RECOMMENDED THAT THE EEPROM COPY FEATURE BE USED WHEREVER POSSIBLE.

This command is used to duplicate the EEPROM memory chip (small 8 pin chip located to the left of the large 40 pin microprocessor chip). Using this command it is possible to make a master EEPROM chip. This master chip may be copied into unprogrammed panels to eliminate most of the programming. Once the master chip is copied into a panel, any changes may still be made using the normal programming commands.

Follow these steps in using this command:

To make a master chip:

1. Use the normal programming method to program into the EEPROM all the information required in the masterchip. The point of making a master chip is to eliminate the repetitive programming for each new installation. Therefore all the information which does not normally change from one installation to the next should be entered in the master.
2. Turn off the power to the panel to the panel and remove the EEPROM. It contains all the required information.
3. Once the desired master chip is created, make several copies of it using the instructions below. Additional blank EEPROMS can be obtained from your DSC distributor.

To copy a master chip into an unprogrammed panel:

1. Remove the EEPROM chip from the panel with the power off.
2. Insert the master chip. Be careful to insert the EEPROM with the pin 1 identification dot to the lower left. If the chip is inserted incorrectly and the power is applied, the chip will be destroyed instantly.

3. Power up the panel and enter [*],[8],[INSTALLER CODE],[50]...
4. All 8 zone lights will go on when the master is loaded into the panel.
5. With power still on, remove the master EEPROM and insert the blank EEPROM back into the panel. Insert in correct direction.
6. With the blank EEPROM inserted press any key. Zone lights will flash for a few seconds while EEPROM is being programmed. If the lights slow down or freeze at a certain point during this programming cycle, the EEPROM is defective. If this happens start from step 1. with a different EEPROM.
7. When the programming is complete the panel will reset and go back to the arm/ disarm state. Enter the programming command again to complete any remaining programming.

HARDWARE RESET OF EEPROM TO FACTORY DEFAULTS

In case that the Installers code is lost through inadvertent reprogramming, the only means of getting back into the system is via a hardware reset.

Follow the sequence outlined below to get back to factory default conditions.

1. Power unit down by removing both AC and battery power.
2. Using a short jumper, short pins marked "EEPROM RESET" together.
3. Power PC2500 up.
4. Wait for 10 seconds then remove shorting jumper.
5. The system will have reloaded the EEPROM with the factory default codes.

PROGRAMMING WORK SHEET

[01] 1ST PHONE NUMBER

--	--	--	--	--	--	--	--	--	--	--	--	--	--	--	--	--	--	--	--

(enter [0] for digit 0 in phone number)

(enter [*4*] (HEX D) for additional dial tone detection between phone number digits as in local PBX systems)
 (be sure to enter [#] to end number)

[02] 1ST CUSTOMER ACCOUNT CODE

--	--	--	--

(for 3 digit code enter [0] for last digit)

(enter [*1*] (HEX A) for digit 0 in account code)

[03] 2ND PHONE NUMBER

--	--	--	--	--	--	--	--	--	--	--	--	--	--	--	--	--	--	--	--

[04] 2ND CUSTOMER ACCOUNT CODE

--	--	--	--

NOT REQUIRED WHEN USING
A SINGLE SYSTEM

[05] ZONES 1 TO 8 ALARM REPORTING CODES

- ZONE 1 ALARM
- ZONE 2 ALARM
- ZONE 3 ALARM
- ZONE 4 ALARM
- ZONE 5 ALARM
- ZONE 6 ALARM
- ZONE 7 ALARM
- ZONE 8 ALARM

(for single digit reporting codes
enter [0] as 2nd digit)
 (enter [*1*] (HEX A) to transmit a 0
 a 0 digit is 10 pulses)

[06] ZONES 1 TO 8 RESTORAL REPORTING CODES

- ZONE 1 ALARM
- ZONE 2 ALARM
- ZONE 3 ALARM
- ZONE 4 ALARM
- ZONE 5 ALARM
- ZONE 6 ALARM
- ZONE 7 ALARM
- ZONE 8 ALARM

[07] UTILITY ALARM REPORTING CODES

- FIRE ZONE*
- AUXILIARY INPUT ZONE*
- BATTERY TROUBLE**
- AC FAILURE TROUBLE**
- FOIL ZONE(S) TROUBLE**
- BELL CIRCUIT TROUBLE**
- FIRE ZONE TROUBLE**
- AUX POWER SUPPLY TROUBLE**

* Priority alarms/restoral
 ** Maintenance alarms/restoral
 see section [27]

[08] UTILITY RESTORAL REPORTING CODES

FIRE ZONE*
 AUXILIARY INPUT ZONE*
 BATTERY TROUBLE**
 AC FAILURE TROUBLE**
 FOIL ZONE(S) TROUBLE**
 BELL CIRCUIT TROUBLE**
 FIRE ZONE TROUBLE**
 AUX POWER SUPPLY TROUBLE**

* Priority alarms/restoral
 ** Maintenance alarms/restoral
 see section [27]

[09] CLOSING (ARMING) REPORTING CODES FOR ACCESS CODES 1 TO 8

ACCESS CODE 1
 ACCESS CODE 2
 ACCESS CODE 3
 ACCESS CODE 4
 ACCESS CODE 5
 ACCESS CODE 6
 ACCESS CODE 7
 ACCESS CODE 8

[10] OPENING (DISARMING) REPORTING CODES FOR ACCESS CODES 1 TO 8

ACCESS CODE 1
 ACCESS CODE 2
 ACCESS CODE 3
 ACCESS CODE 4
 ACCESS CODE 5
 ACCESS CODE 6
 ACCESS CODE 7
 ACCESS CODE 8

[11] MISCELLANEOUS FUNCTIONS REPORTING CODES

PARTIAL CLOSING***
 KEYPAD PANIC ALARM [*][#]*
 KEYPAD FIRE ALARM [1][3]*
 KEYPAD EMERGENCY ALARM [4][6]*
 KEYPAD PANIC RESTORAL [*][#]*
 KEYPAD FIRE RESTORAL [1][3]*
 KEYPAD EMERGENCY RESTORAL [4][6]*
 PERIODIC TEST TRANSMISSION**

* Priority alarms/restoral
 ** Maintenance alarms/restoral
 see section [27]
 ***Transmission reports with
 section [9] & [10] (openings
 closings)

[12] ZONE DEFINITIONS FOR ZONES 1 TO 8

ZONE 1	<input type="checkbox"/>	<input type="checkbox"/>
ZONE 2	<input type="checkbox"/>	<input type="checkbox"/>
ZONE 3	<input type="checkbox"/>	<input type="checkbox"/>
ZONE 4	<input type="checkbox"/>	<input type="checkbox"/>
ZONE 5	<input type="checkbox"/>	<input type="checkbox"/>
ZONE 6	<input type="checkbox"/>	<input type="checkbox"/>
ZONE 7	<input type="checkbox"/>	<input type="checkbox"/>
ZONE 8	<input type="checkbox"/>	<input type="checkbox"/>

1ST DIGIT
 0= SLOW, AUDIBLE
 # 1= SLOW, SILENT
 2= FAST, AUDIBLE
 # 3= FAST, SILENT

2ND DIGIT
 0= DELAY
 1= INSTANT
 2= INTERIOR
 3= INTERIOR... HOME/AWAY
 4= 24HR...BELL
 5= 24HR...BELL/BUZZER
 # 6= 24HR...BUZZER
 * 7= DOUBLE DELAY
 * 8= 4x DELAY
 9= FOIL

* The maximum delays allowed for U.L. installations are: Entry delay = 45 sec.
 Exit delay = 60'
 # Not allowed for U.L. Local installations

FACTORY PROGRAMMED (DEFAULT)

ZONE	
1	0 0
2	0 1
3	0 1
4	0 1
5	0 2
6	0 2
7	0 2
8	0 4

[13] 1ST SYSTEM OPTION CODE

ZONE LIGHT		1ST SYSTEM OPTION CODE	2ND SYSTEM OPTION CODE	3RD SYSTEM OPTION CODE
ZONE LIGHT 1	<input type="checkbox"/>	ZONE LIGHT ON	ZONE LIGHT OFF	
ZONE LIGHT 2	<input type="checkbox"/>	DISABLE COMMUNICATIONS	ENABLE COMMUNICATIONS	OFF
ZONE LIGHT 3	<input type="checkbox"/>	RESTORE ON BELL TIMEOUT	RESTORE ON DISARM	OFF
ZONE LIGHT 4	<input type="checkbox"/>	DISPLAY ZONE/PANEL ARMED	OPTION OFF	OFF
ZONE LIGHT 5	<input type="checkbox"/>	DTMF DIALING	PULSE DIALING	OFF
ZONE LIGHT 6	<input type="checkbox"/>	N/C LOOPS	EOL RESISTORS LOOPS	OFF
ZONE LIGHT 7	<input type="checkbox"/>	KEYPAD PANIC AUDIBLE [*][#]	SILENT	OFF
ZONE LIGHT 8	<input type="checkbox"/>	CALL 1ST PHONE ONLY	BACK UP TO 2ND PHONE	ON
		8TH CODE - MAID'S CODE	NORMAL CODE	OFF

[14] 2ND SYSTEM OPTION CODE

ZONE LIGHT		1ST SYSTEM OPTION CODE	2ND SYSTEM OPTION CODE	3RD SYSTEM OPTION CODE
ZONE LIGHT 1	<input type="checkbox"/>	ZONE LIGHT ON	ZONE LIGHT OFF	
ZONE LIGHT 2	<input type="checkbox"/>	50 Hz.	60 Hz.	OFF
ZONE LIGHT 3	<input type="checkbox"/>	FIXED MASTER	CHANGEABLE MASTER	OFF
ZONE LIGHT 4	<input type="checkbox"/>	BELL SQUAWK ON	BELL SQUAWK OFF	OFF
ZONE LIGHT 5	<input type="checkbox"/>	OUTPUT MODULE ACTIVE	OFF	OFF
ZONE LIGHT 6	<input type="checkbox"/>	TLM SILENT	TLM AUDIBLE	OFF
ZONE LIGHT 7	<input type="checkbox"/>	1400 Hz RADIONICS	2300Hz RADIONICS	OFF
ZONE LIGHT 8	<input type="checkbox"/>	TLM DISABLED (1)	TLM ENABLED	OFF
		USER CODE REQ'D FOR SHUNT	USER CODE NOT REQ'D	OFF

(1) If this equipment is not connected to a telephone line then TLM should be disabled.

[15] ZONES 1 TO 8 BY-PASS (SHUNT) MASK

ZONE LIGHT 1	<input type="checkbox"/>
ZONE LIGHT 2	<input type="checkbox"/>
ZONE LIGHT 3	<input type="checkbox"/>
ZONE LIGHT 4	<input type="checkbox"/>
ZONE LIGHT 5	<input type="checkbox"/>
ZONE LIGHT 6	<input type="checkbox"/>
ZONE LIGHT 7	<input type="checkbox"/>
ZONE LIGHT 8	<input type="checkbox"/>

(IF ZONE LIGHT IS ON, THE ZONE CAN BE BY-PASSED USING THE [*][1] COMMAND)

ZONE LIGHT	
1	ON
2	ON
3	ON
4	ON
5	ON
6	ON
7	ON
8	ON

[16] SYSTEM TIMES

ENTRY DELAY TIME (IN SECONDS)
 EXIT DELAY TIME (IN SECONDS)
 BELL CUT-OFF TIME (IN MINUTES)
 AC FAILURE TRANSMISSION DELAY (IN MINUTES)
 NORMAL LOOP RESPONSE TIME (X 10 MSEC)
 TEST TRANSMISSION CYCLE TIME (IN DAYS)

<input type="checkbox"/>	<input type="checkbox"/>
<input type="checkbox"/>	<input type="checkbox"/>
<input type="checkbox"/>	<input type="checkbox"/>
<input type="checkbox"/>	<input type="checkbox"/>
<input type="checkbox"/>	<input type="checkbox"/>
<input type="checkbox"/>	<input type="checkbox"/>

(VALID ENTRIES ARE 01 TO 99)

3	0
4	5
0	4
0	1
1	0
0	1

[17] SYSTEM CLOCK TIMES

AUTOMATIC ARMING TIME OF DAY
 TEST TRANSMISSION TIME OF DAY

(ENTER 4 DIGITS...
 00 TO 23 FOR HOURS
 FOLLOWED BY 00
 TO 59 FOR MINUTES)

FACTORY
 PROGRAMMED
 (DEFAULT)

[18] NEW INSTALLER'S CODE

[19] NEW MASTER CODE

[20] FOR FUTURE USE

(ENTER 4 DIGITS FROM 0 TO 9 DO NOT ENTER [*] OR [#])

2	5	0	0
1	2	3	4

[21] COMMUNICATOR FORMAT OPTIONS

1ST TELEPHONE NUMBER

2ND TELEPHONE NUMBER

1
1

ENTER ONE HEX DIGIT FROM [0] TO [F] FOR EACH PHONE NUMBER FROM LIST:

- [0] SILENT KNIGHT/ADEMCO SLOW, 10 BPS (1400HZ HANDSHAKE) 3/1, 3/2 AND 4/2 NON EXTENDED FORMAT
 - [1] SESCOA, FRANKLIN, DCI, VERTEX, 20 BPS (2300HZ HANDSHAKE) 3/1, 3/2 AND 4/2 NON EXTENDED FORMAT
 - [2] SILENT KNIGHT FAST, 20 BPS (1400HZ HANDSHAKE) 3/1, 3/2 AND 4/2 NON EXTENDED FORMAT
 - [3] RADIONICS, (2300/1400HZ* HANDSHAKE) 3/1, 4/2 NON EXTENDED FORMAT
 - [4] RADIONICS, (2300/1400HZ* HANDSHAKE) 3/1, 4/2 NON EXTENDED WITH PARITY FORMAT
 - [5] FOR FUTURE USE
 - [6] FOR FUTURE USE
 - [7] FOR FUTURE USE
 - [8] SILENT KNIGHT/ADEMCO SLOW, 10 BPS (1400HZ HANDSHAKE) 3/1 EXTENDED FORMAT
 - [9] SESCOA, FRANKLIN, DCI, VERTEX, 20 BPS (2300HZ HANDSHAKE) 3/1 EXTENDED FORMAT
 - [A] SILENT KNIGHT FAST, 20 BPS (1400HZ HANDSHAKE) 3/1 EXTENDED FORMAT
 - [B] RADIONICS, (2300/1400HZ* HANDSHAKE) 3/1 EXTENDED FORMAT
 - [C] RADIONICS, (2300/1400HZ* HANDSHAKE) 3/1 AND 4/1 EXTENDED WITH PARITY FORMAT
 - [D] FOR FUTURE USE
 - [E] FOR FUTURE USE
 - [F] FOR FUTURE USE
- *SEE SECTION [14] FOR RADIONICS HANDSHAKE OPTION

[22] PROGRAMMABLE INPUT AND OUTPUT OPTIONS

AUXILIARY INPUT ZONE

ENTER 1, 2 OR 3 FOR OPTIONS BELOW

2

- [1] SILENT 24 HOUR INPUT
 - [2] AUDIBLE 24 HOUR INPUT
 - [3] MOMENTARY KEY ARMING
- 1, 2 or 3 ARE THE ONLY VALID ENTRIES

PROGRAMMABLE OUTPUT

ENTER 1 TO HEX B FOR OPTIONS BELOW

6

- [1] GROUND START PULSE
 - [2] UTILITY OUTPUT NO ACCESS CODE
 - [3] UTILITY OUTPUT ANY ACCESS CODE
 - [4] UTILITY OUTPUT GROUP A ACCESS CODE
 - [5] UTILITY OUTPUT GROUP B ACCESS CODE
 - [6] KEYPAD BUZZER FOLLOW MODE
 - [7] SYSTEM STATUS (ARM/DISARM) OUTPUT
 - [8] STROBE OUTPUT (LATCHED ALARM OUTPUT)
 - [9] FAILURE TO COMMUNICATE OUTPUT
- 1 thru 9 ARE THE ONLY VALID ENTRIES

NOTE: SECTIONS [23] - [27] ARE USED FOR SPLIT-ARMING/REPORTING ONLY.
 SECTIONS [23] - [26] MUST ALL BE ON FOR A SINGLE SYSTEM.

FACTORY
 PROGRAMMED
 (DEFAULT)

[23] ZONE GROUP A ASSIGNMENT

ZONE LIGHT 1

ZONE LIGHT 2

ZONE LIGHT 3

ZONE LIGHT 4

ZONE LIGHT 5

ZONE LIGHT 6

ZONE LIGHT 7

ZONE LIGHT 8

IF ZONE LIGHT IS ON THAT ZONE IS
 ASSIGNED TO GROUP A

NOTE: IF ZONE IS NOT ASSIGNED
 TO GROUP A OR B
 NO TRANSMISSION WILL BE SENT.

1 ON

2 ON

3 ON

4 ON

5 ON

6 ON

7 ON

8 ON

[24] ZONE GROUP B ASSIGNMENT

ZONE LIGHT 1

ZONE LIGHT 2

ZONE LIGHT 3

ZONE LIGHT 4

ZONE LIGHT 5

ZONE LIGHT 6

ZONE LIGHT 7

ZONE LIGHT 8

IF ZONE LIGHT IS ON THAT ZONE IS
 ASSIGNED TO GROUP B

1 ON

2 ON

3 ON

4 ON

5 ON

6 ON

7 ON

8 ON

[25] ACCESS CODE GROUP A ASSIGNMENT

ZONE LIGHT 1

ZONE LIGHT 2

ZONE LIGHT 3

ZONE LIGHT 4

ZONE LIGHT 5

ZONE LIGHT 6

ZONE LIGHT 7

ZONE LIGHT 8

IF ZONE LIGHT IS ON THAT ACCESS CODE
 IS ASSIGNED TO GROUP A

NOTE: IF ACCESS CODE IS NOT ASSIGNED
 TO GROUP A OR B OPENING AND CLOSING
 SIGNAL WILL NOT BE SENT.

1 ON

2 ON

3 ON

4 ON

5 ON

6 ON

7 ON

8 ON

[26] ACCESS CODE GROUP B ASSIGNMENT

ZONE LIGHT 1

ZONE LIGHT 2

ZONE LIGHT 3

ZONE LIGHT 4

ZONE LIGHT 5

ZONE LIGHT 6

ZONE LIGHT 7

ZONE LIGHT 8

IF ZONE LIGHT IS ON THAT ACCESS CODE
 IS ASSIGNED TO GROUP B

1 ON

2 ON

3 ON

4 ON

5 ON

6 ON

7 ON

8 ON

[27] COMMUNICATOR CALL DIRECTION OPTIONS

ZONES GROUP A ALARMS AND RESTORALS

ZONES GROUP B ALARMS AND RESTORALS

ACCESS CODES GROUP A OPENINGS AND CLOSINGS

ACCESS CODES GROUP B OPENINGS AND CLOSINGS

PRIORITY ALARMS AND RESTORALS

MAINTENANCE ALARMS AND RESTORALS

1 1

1 1

1 1

1 1

1 1

1 1

ENTER:

- [1] Call 1st phone number back up to 2nd (becomes 1st number only when section [13] item [7] is on)
- [2] Call 2nd phone number only
- [3] Always call both phone numbers

[28] RESET EEPROM MEMORY TO FACTORY DEFAULTS

[50] EEPROM COPY FUNCTION

NOTE: The EEPROM copy function will copy all data programmed into the PC2500
 except for additional user codes programmed.

FCC COMPLIANCE STATEMENT

This equipment generates and uses radio frequency energy and if not installed and used properly, in strict accordance with the manufacturer's instructions, may cause interference to radio and television reception. It has been type tested and found to comply with the limits for class "B" device in accordance with the specifications in Subpart "J" of Part 15 of FCC Rules, which are designed to provide reasonable protection against such interference in any residential installation. However, there is no guarantee that interference will not occur in a particular installation. If this equipment does cause interference to television or radio reception, which can be determined by turning the equipment off and on, the user is encouraged to try to correct the interference by one or more of the following measures:

- Re-orient the receiving antenna.
- Relocate the alarm control with respect to the receiver.
- Move the alarm control away from the receiver.
- Connect the alarm control into a different outlet so that alarm control and receiver are on different circuits.

If necessary, the user should consult the dealer or an experienced radio/television technician for additional suggestions. The user may find the following booklet prepared by the FCC helpful:

"How to Identify and Resolve Radio/Television Interference Problems." This booklet is available from the U.S. Government Printing Office, Washington, D.C. 20402, Stock # 004-000-00345-4.

IMPORTANT INFORMATION

Notification to Telephone Company

Upon request, the customer shall notify the telephone company of the particular line to which the connection will be made, and provide FCC registration number and the ringer equivalence of the protective circuit.

FCC Registration Number: F534J3-72668-AL-E

Ringer Equivalence Number: 0.0B

Malfunction of the Equipment

In the event that the PC2500 should fail to operate properly, the customer shall disconnect the equipment from the telephone line to determine if it is the customer's equipment which is not working properly, or if the problem is with the telephone company network. If the problem is with the PC2500, the customer shall discontinue use until it is repaired.

Telephone Connection Requirements

Except for the telephone company provided ringers, all connections to the telephone network shall be made through standard plugs and telephone company provided jacks, or equivalent, in such a manner as to allow for easy, immediate disconnection of the terminal equipment. Standard jacks shall be so arranged that, if the plug connected thereto is withdrawn, no interference to the operation of the equipment at the customer's premises which remains connected to the telephone network shall occur by reason of such withdrawal.

Incidence of Harm

Should terminal equipment or protective circuitry cause harm to the telephone network, the telephone company shall, where practicable, notify the customer that temporary disconnection of service may be required; however, where prior notice is not practicable, the telephone company may temporarily discontinue service if such action is deemed reasonable in the circumstances. In the case of such temporary discontinuance, the telephone company shall promptly notify the customer and will be given the opportunity to correct the situation. The customer also has the right to bring a complaint to the FCC if he feels the disconnection is not warranted.

Change in Telephone Company Equipment of Facilities

The Telephone Company may make changes in its communications facilities, equipment, operations or procedures, where such actions is reasonably required and proper in its business. Should any such changes render the customer's terminal equipment incompatible with the telephone company facilities the customer shall be given adequate notice to the effect the modifications to maintain uninterrupted service.

General

This equipment should not be used on coin telephone lines. Connection to party line service is subject to state tariffs.

Ringer Equivalence Number (REN)

The REN is useful to determine the quantity of devices that you may connect to your telephone line and still have all of those devices ring when your telephone number is called. In most, but not all areas, the sum of the REN's of all devices connected to one line should not exceed five (5). To be certain of the number of devices that you may connect to your line, you may want to contact your local telephone company.

EQUIPMENT MAINTENANCE FACILITY

Digital Security Controls Ltd.
160 Washburn
Lockport, NY 14094

LIMITED WARRANTY

Digital Security Controls Ltd. warrants that for a period of twelve months from the date of purchase, the product shall be free of defects in materials and workmanship under normal use and that in fulfillment of any breach of such warranty, Digital Security Controls Ltd. shall, at its option, repair or replace the defective equipment upon return of the equipment to its factory. This warranty applies only to defects in parts and workmanship and not to damage incurred in shipping or handling, or damage due to causes beyond the control of Digital Security Controls Ltd. such as lightning, excessive voltage, mechanical shock, water damage, or damage arising out of abuse, alteration or improper application of the equipment.

The foregoing warranty shall apply only to the original buyer, and is and shall be in lieu of any and all other warranties, whether expressed or implied and of all other obligations or liabilities on the part of Digital Security Controls Ltd. This warranty contains the entire warranty. Digital Security Controls Ltd. neither assumes, nor authorizes any other person purporting to act on its behalf to modify or to change this warranty, nor to assume for it any other warranty or liability concerning this product.

In no event shall Digital Security Controls Ltd. be liable for any direct, indirect or consequential damages, loss of anticipated profits, loss of time or any other losses incurred by the buyer in connection with the purchase, installation or operation or failure of this product.

WARNING: Digital Security Controls Ltd. recommends that the entire system be completely tested on a regular basis. However, despite frequent testing, and due to, but not limited to, criminal tampering or electrical disruption, it is possible for this product to fail to perform as expected.